



Army Corps of
Engineers
Galveston District

**ADDICKS AND BARKER RESERVOIRS
BUFFALO BAYOU AND TRIBUTARIES
SAN JACINTO RIVER BASIN, TEXAS**

WATER CONTROL MANUAL

September 2019
Reservoir Regulation Manual – April 1962
Revised Water Control Manual – November 2012

FOR OFFICIAL USE ONLY (FOUO)

ADDICKS AND BARKER RESERVOIRS
BUFFALO BAYOU AND TRIBUTARIES
SAN JACINTO RIVER BASIN, TEXAS

WATER CONTROL MANUAL
SAN JACINTO RIVER BASIN

SEPTEMBER 2019
RESERVOIR REGULATION MANUAL – APRIL 1962
REVISED WATER CONTROL MANUAL – NOVEMBER 2012

Department of the Army
Corps of Engineers
Galveston District

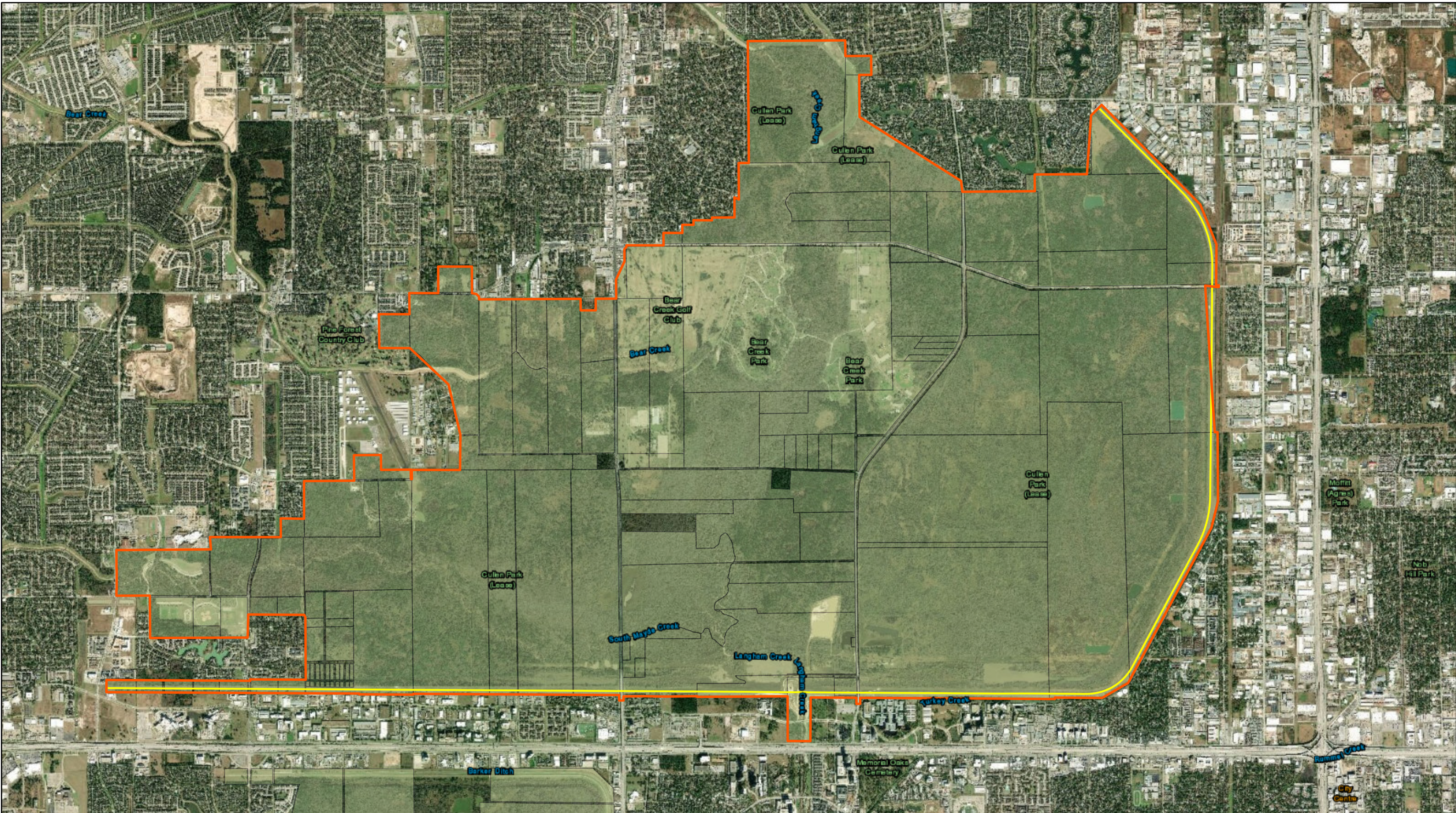

Legend
 Addicks Reservoir
 Addicks Centerline of Dam



5 XXJW_g'FYgYfj cJf '5 YfJU' JJK

iii

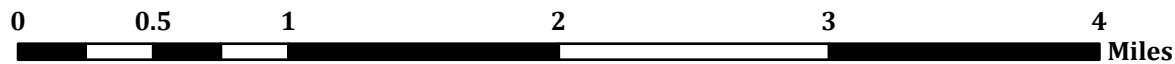

The data is only a representation of features on the earth completed by a computer program from raw data obtained from different sources and is not necessarily, in whole or in part, based upon any physical recording, study or survey, professional or otherwise, of the covered property. This information is not intended as a substitute for a field survey by a professional or any other use or application that requires legal or engineering accuracy.





ADDICKS RESERVOIR – OUTLET WORKS (AUGUST 2019)

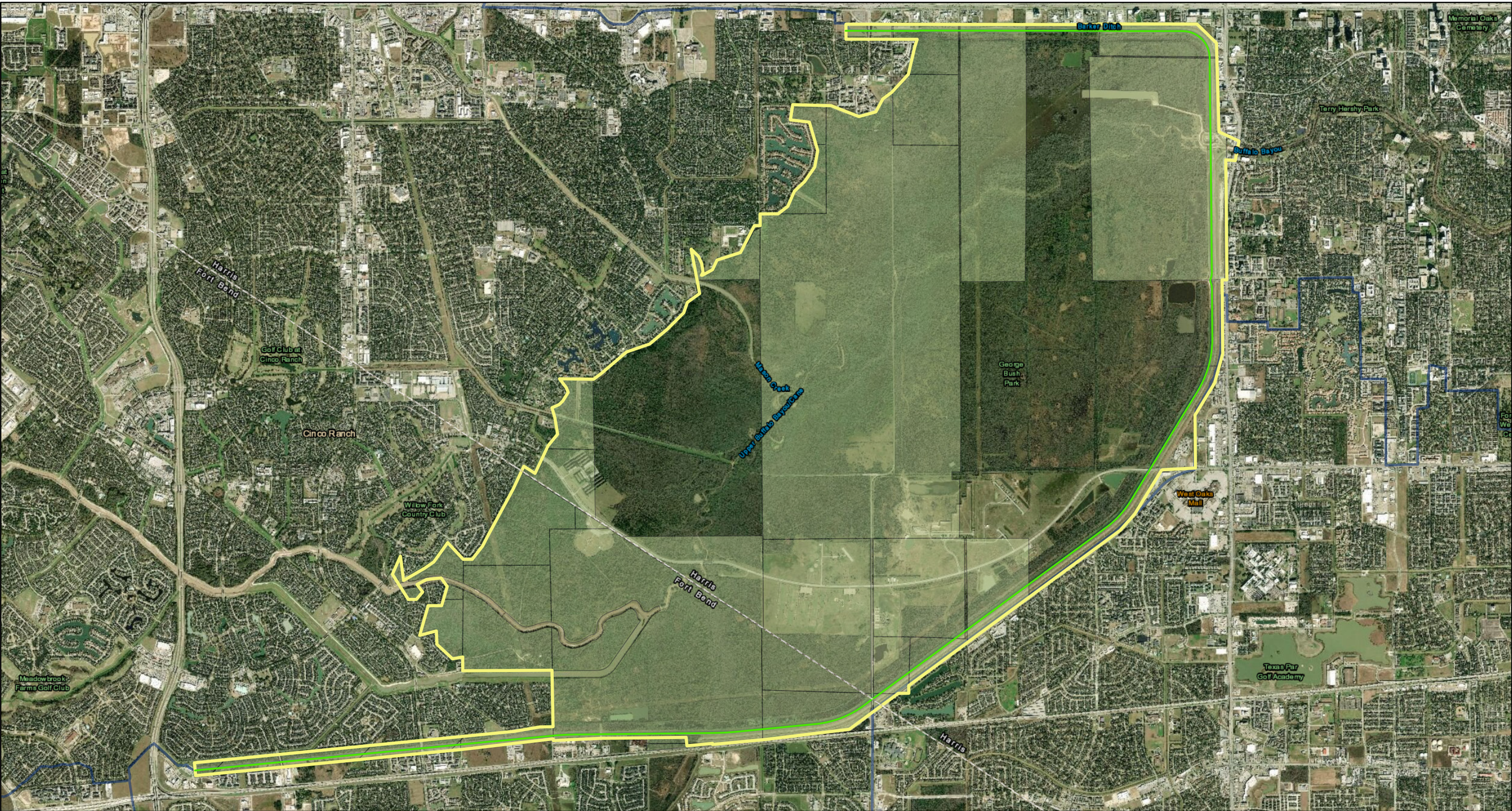

Legend
 Yellow outline: Barker Reservoir
 Green line: Barker Centerline of Dam



Barker Reservoir Aerial View

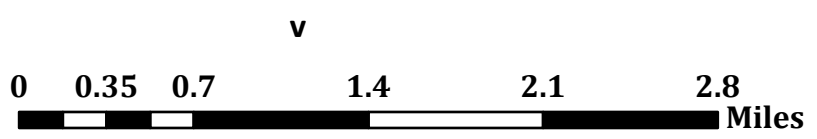

The data is only a representation of features on the earth completed by a computer program from raw data obtained from different sources and is not necessarily, in whole or in part, based upon any physical recording, study or survey, professional or otherwise, of the covered property. This information is not intended as a substitute for a field survey by a professional or any other use or application that requires legal or engineering accuracy.





BARKER RESERVOIR – OUTLET WORKS (AUGUST 2019)

NOTICE TO USERS OF THIS MANUAL

Regulations also specify that this Water Control Manual can be used in a loose-leaf form and only those sections or parts thereof requiring changes will be revised and printed. Therefore, this copy should be preserved in good condition so that inserts can be made to keep the manual current. All elevations referred to in this Water Control Manual, unless otherwise noted, are in feet, NAVD 1988 (North American Vertical Datum of 1988). See paragraph 1-07, Page 1-2, for more details on elevation shifts to this Datum.

Regulations also specify that electronic copies and notifications of this Water Control Manual and Subsequent revisions shall be forwarded to HQUSACE (CECW-CE) for file purposes as soon as practicable after completion, preferably within 30 days of date of approval at the Division level. This Water Control Manual shall be published in digital form in the central repository located at the following link:

<https://maps.crrel.usace.army.mil/apex/f?p=875:1>

The Water Control Manual at the central repository will be considered the official manual and will be kept current at all times. Instructions and information to upload or document the review status of the Water Control Manual, as per Engineering Regulation (ER) 1110-2-240, in the central repository portal can be found under the help tab in the portal.

It is not unexpected that USACE Corporate Information may move the central repository link to a new location. This information will be shared with all offices if a situation occurs by the HQUSACE.

REGULATION ASSISTANCE PROCEDURES

In the event that unusual conditions arise during non-duty hours, communication can be achieved by contacting, in the order listed, one of the following personnel shown below. Chapter VII of this manual contains detailed instructions for emergency regulation. All project personnel associated with regulation of the projects must be thoroughly familiar with this and the procedure outlined in Exhibit C.

EMERGENCY PERSONNEL ROSTER

OFFICE	NAME	OFFICE*	GOVT. CELL
<i>ADDICKS PROJECT OFFICE</i>			
	Addicks Field Office Main Line		Presently Offline
	Addicks Field Office Fax Line		Presently Offline
	[REDACTED]	[REDACTED]	[REDACTED]
	[REDACTED]	[REDACTED]	[REDACTED]
	[REDACTED]	[REDACTED]	[REDACTED]
	[REDACTED]	[REDACTED]	[REDACTED]
<i>WATER CONTROL</i>			
	[REDACTED]	[REDACTED]	[REDACTED]
	[REDACTED]	[REDACTED]	[REDACTED]
	[REDACTED]	[REDACTED]	[REDACTED]
	[REDACTED]	[REDACTED]	[REDACTED]
<i>OPERATIONS DIVISION</i>			
	[REDACTED]	[REDACTED]	[REDACTED]
	[REDACTED]	[REDACTED]	[REDACTED]
<i>DAM SAFETY</i>			
	[REDACTED]	[REDACTED]	[REDACTED]
	[REDACTED]	[REDACTED]	[REDACTED]
<i>EMERGENCY OPERATIONS</i>			
	[REDACTED]		[REDACTED]
	[REDACTED]		[REDACTED]
	[REDACTED]	[REDACTED]	[REDACTED]
	[REDACTED]	[REDACTED]	[REDACTED]

*All office extensions begin with [REDACTED]

TABLE OF CONTENTS
Addicks and Barker Reservoirs
Water Control Manual
Buffalo Bayou and Tributaries
San Jacinto River Basin, Texas

TITLE PAGE	i
PHOTOGRAPHS	iii
NOTICE TO USERS OF THIS MANUAL	vii
EMERGENCY REGULATION ASSISTANCE PROCEDURES	viii
TABLE OF CONTENTS	ix
PERTINENT DATA	xvi

I - Introduction

1-01. Authorization for Manual	1-1
1-02. Purpose and Scope.....	1-1
1-03. Related Manuals and Reports.....	1-1
1-04. Project Owner	1-1
1-05. Operating Agency	1-1
1-06. Regulating Agencies	1-2
1-07. Vertical Datum	1-2

II - Description of Project

2-01. Location	2-1
2-02. Purpose	2-1
2-03. Physical Components	2-1
a. Addicks Dam	2-1
b. Addicks Outlet Works	2-1
c. Barker Dam	2-2
d. Barker Outlet Works	2-2
2-04. Related Control Facilities	2-2
2-05. Real Estate Acquisition	2-2
2-06. Public Facilities	2-3
a. Addicks Reservoir.....	2-3
b. Barker Reservoir.....	2-3

III - History of Project

3-01. Authorization of Project	3-1
3-02. Planning and Design	3-1
3-03. Construction.....	3-3

3-04.	Related Projects.....	3-5
3-05.	Dam Safety History/Issues	3-5
3-06.	Principal Regulation Problems	3-6
3-07.	Modifications to Regulations	3-7

IV - Watershed Characteristics

4-01.	General Characteristics.....	4-1
	a. Buffalo Bayou Watershed	4-1
	b. Barker Reservoir Watershed.....	4-1
	c. Addicks Reservoir Watershed.....	4-1
	d. Cypress Creek Watershed.....	4-1
4-02.	Topography.....	4-1
4-03.	Geology and Soils.....	4-2
	a. Addicks Dam	4-2
	b. Barker Dam	4-3
	c. Groundwater Conditions	4-4
	d. Subsidence.....	4-4
4-04.	Sediment.....	4-4
4-05.	Climate.....	4-5
	a. General.....	4-5
	b. Temperature	4-5
	c. Precipitation.....	4-5
	d. Evaporation	4-6
	e. Wind	4-7
4-06.	Storms and Floods.....	4-7
4-07.	Runoff Characteristics	4-7
4-08.	Water Quality	4-8
4-09.	Channel and Floodway Characteristics	4-8
4-10.	Upstream Structures	4-9
4-11.	Downstream Structures	4-9
4-12.	Economic Data.....	4-9
	a. Population.....	4-9
	b. Agriculture	4-9
	c. Industry.....	4-9
	d. Recreation	4-9
	e. Flood Damages	4-10

V - Data Collection and Communication Network

5-01.	Hydrometeorological Stations	5-1
	a. Facilities.....	5-1
	b. Reporting	5-2
	c. Maintenance.....	5-3
5-02.	Water Quality Stations	5-4
	a. Facilities.....	5-4
	b. Reporting.....	5-4

	c. Maintenance.....	5-4
5-03.	Sediment Stations.....	5-4
	a. Facilities.....	5-4
	b. Reporting.....	5-4
	c. Maintenance.....	5-4
5-04.	Recording Hydrologic Data.....	5-4
	a. Project Data.....	5-4
	b. Stream Gage Data.....	5-5
	c. Precipitation Data.....	5-5
5-05.	Communications Network.....	5-5
5-06.	Communication with the Project Office.....	5-5
	a. Communication between Regulating Office and Project Office.....	5-6
	b. Communication between Regulating/Project Office and Others.....	5-6
5-07.	Project Reporting Instructions.....	5-6
5-08.	Warnings.....	5-7
	a. Local Warnings.....	5-7
	b. Flood Emergency Plan.....	5-7
5-09.	Routine Information for Public Release.....	5-8

VI - Hydrologic Forecasts

6-01.	General.....	6-1
	a. Role of the Corps.....	6-1
	b. Role of Other Agencies.....	6-1
6-02.	Flood Condition Forecasts.....	6-2
	a. Requirements.....	6-2
	b. Methods.....	6-2
6-03.	Conservation Purpose Forecasts.....	6-3
	a. Requirements.....	6-3
	b. Methods.....	6-3
6-04.	Long Range Forecasts.....	6-3
	a. Requirements.....	6-3
	b. Methods.....	6-3
6-05.	Drought Forecast.....	6-3
	a. Requirements.....	6-3
	b. Methods.....	6-4
6-06.	Water Quality Forecasting.....	6-4
	a. Requirements.....	6-4
	b. Methods.....	6-4

VII - Water Control Plan

7-01.	General Objectives.....	7-1
7-02.	Constraints.....	7-1
	a. Spillway Design Flood Impacts.....	7-1
	b. Upstream Reservoir Impacts.....	7-1
	c. Reservoir Release Restrictions.....	7-2
	d. Pool Drawdown Rate.....	7-2

7-03.	Overall Plan for Water Control Management.....	7-2
7-04.	Standing Instructions to Project Operator (Damtender)	7-2
	a. Normal Operation	7-2
	b. Emergency Operations	7-3
7-05.	Flood Risk Management	7-4
	a. Normal Flood Control Regulation.....	7-4
	b. Induced Surcharge Flood Control Regulation.	7-5
	c. Constraints Regarding Flood Control Operation	7-6
7-06.	Recreation.....	7-6
	a. Land Usage	7-6
	b. Reservoir Regulation For Special Events.....	7-6
7-07.	Water Quality	7-7
7-08.	Fish and Wildlife.....	7-7
7-09.	Water Conservation/Water Supply.....	7-7
7-10.	Hydroelectric Power	7-7
7-11.	Navigation	7-7
7-12.	Drought Contingency Plans.....	7-7
7-13.	Flood Emergency Action Plans	7-8
7-14.	Other.....	7-8
7-15.	Deviation from Normal Regulation	7-8
	a. Emergencies.....	7-8
	b. Unplanned Minor Deviations.....	7-8
	c. Planned Deviations.....	7-9
	d. Unplanned Major Deviations.....	7-9
7-16.	Rate of Release Change.....	7-9
7-17.	Operation Curves and Tables	7-9

VIII - Effect of Water Control Plan

8-01.	General.....	8-1
8-02.	Flood Risk Management	8-1
	a. Spillway Design Flood	8-1
	b. Standard Project Flood	8-2
	c. Other Floods.....	8-3
8-03.	Recreation.....	8-4
8-04.	Water Quality	8-5
8-05.	Fish and Wildlife.....	8-5
8-06.	Water Conservation/Water Supply	8-5
8-07.	Hydroelectric Power	8-5
8-08.	Navigation	8-5
8-09.	Drought Contingency Plans.....	8-5
8-10.	Flood Emergency Action Plan.....	8-5
8-11.	Frequencies	8-6
	a. Peak Inflow Probability	8-6
	b. Pool Elevation Duration and Frequency.....	8-6
	c. Key Control Points	8-6
8-12.	Other Studies.....	8-7

a. Examples of Regulation	8-7
b. Channel and Floodway Improvement	8-7
c. Miscellaneous Studies	8-7

IX - Water Control Management

9-01. Responsibilities and Organization	9-1
a. USACE	9-1
b. Other Federal Agencies	9-1
c. State, County, and Local Agencies	9-2
d. Private Organizations	9-2
9-02. Interagency Coordination	9-2
a. Local Press and USACE Bulletins	9-2
b. National Weather Service	9-2
c. U.S. Geological Survey	9-2
d. Power Marketing Agency	9-2
e. Other Federal, State, or Local Agencies	9-2
9-03. Interagency Agreements	9-2
9-04. Commissions, River Authorities, Compacts, and Committees	9-2
9-05. Non-Federal Hydropower	9-2
9-06. Reports	9-3
a. Daily Reservoir Report	9-3
b. Monthly Reservoir Report	9-3
c. Flood Damage Report	9-3
d. Post Flood Report	9-3
e. Annual Report	9-3
f. Summary of Reports	9-4

TABLE INDEX

<u>Table</u>	<u>Title</u>	<u>Page</u>
3-01	History of Construction Activities	3-4
4-01	Temperature Data	4-5
4-02	Average Monthly and Annual Rainfall	4-6
4-03	Average Inflow Volumes at Addicks and Barker Reservoirs Recorded for Project Releases	4-8
4-04	Population of Counties in the Vicinity of Addicks and Barker Reservoirs.....	4-9
4-05	Damages Prevented by Addicks and Barker Reservoirs (FY 1980 through FY 2018)	4-11
5-01	Streamgaging Stations Pertinent to Addicks and Barker Reservoirs.....	5-2
8-01	Addicks Reservoir - Other Significant Flood Events	8-4
8-02	Barker Reservoir - Other Significant Flood Events	8-4
8-03	Peak Inflow from USGS Bulletin 17C Analysis	8-6
9-01	Tabulation of Reports	9-4

SUPPLEMENTARY TABLES

<u>Table</u>	<u>Title</u>	<u>Page</u>
1-01	Pertinent Manuals and Reports for Addicks and Barker Reservoirs.....	T1.01-1
7-01	Elevation-Area/Capacity Table - Addicks Reservoir.....	T7.01-1
7-02	Elevation-Area/Capacity Table - Barker Reservoir.....	T7.02-1

EXHIBIT INDEX

EXHIBIT A:	Supplementary Pertinent Data
EXHIBIT B:	Policy Letter to Harris County
EXHIBIT C:	Standing Instructions to Damtender

PLATE INDEX

<u>Plate</u>	<u>Title</u>
2-01	Vicinity Map – Addicks and Barker Reservoirs
2-02	Dam and Spillway Typical Sections – Addicks Reservoir
2-03	Dam and Spillway Typical Sections – Barker Reservoir
2-04	Outlet Works Plan and Profile – Addicks Reservoir
2-05	Outlet Works Plan and Profile – Barker Reservoir
2-06	Addicks Reservoir – Public Facilities
2-07	Barker Reservoir – Public Facilities
3-01	Water Surface Profiles and Floor Elevations – Buffalo Bayou
3-02	Water Surface Profiles and Floor Elevations – Buffalo Bayou
4-01	Drainage Area Map – Addicks, Barker, Cypress Creek, and Buffalo Bayou Watersheds
4-02	Discharge Rating Curve – Buffalo Bayou at Piney Point, TX
5-01	Stream Gauge Locations – Addicks and Barker Reservoirs
5-02	Constant Flow Inundation Maps – Addicks and Barker Reservoirs
5-03	Constant Flow Inundation Map Section 1 – Addicks and Barker Reservoirs
5-04	Constant Flow Inundation Map Section 2 – Addicks and Barker Reservoirs
5-05	Constant Flow Inundation Map Section 3 – Addicks and Barker Reservoirs
5-06	Constant Flow Inundation Map Section 4 – Addicks and Barker Reservoirs
5-07	Constant Flow Inundation Map Section 5 – Addicks and Barker Reservoirs
5-08	Constant Flow Inundation Map Section 6 – Addicks and Barker Reservoirs
7-01	Area-Capacity Curves – Addicks Reservoir
7-02	Area-Capacity Curves – Barker Reservoir
7-03	Induced Surcharge Operation Schedule – Addicks Reservoir
7-04	Induced Surcharge Operation Schedule – Barker Reservoir
7-05	Outlet Works Rating Curves – Addicks Reservoir
7-06	Outlet Works Rating Curves – Barker Reservoir
8-01	1977 Spillway Design Flood – Addicks Reservoir
8-02	1977 Spillway Design Flood – Barker Reservoir
8-03	1977 Standard Project Flood – Addicks Reservoir

8-04	1977 Standard Project Flood – Barker Reservoir
8-05	Pool Inflow-Frequency Curve – Addicks Reservoir
8-06	Pool Inflow-Frequency Curve – Barker Reservoir
8-07	Pool Elevation-Frequency Curve – Addicks Reservoir
8-08	Pool Elevation-Frequency Curve – Barker Reservoir
9-01	Organization and Communication Chart for Water Management

PERTINENT DATA ADDICKS AND BARKER RESERVOIRS

ITEM	ADDICKS RESERVOIR	BARKER RESERVOIR		
DRAINAGE AREA	136 square miles	130 square miles		
DAMS				
Type	Rolled earth embankment	Rolled earth embankment		
Length	61,166 feet	71,900 feet		
Height (above stream bed)	48.5 feet	36.5 feet		
RESERVOIR	Elevation <u>feet (1)</u>	Storage Capacity <u>acre-</u> <u>feet</u>	Elevation <u>Feet (1)</u>	Storage Capacity <u>acre-feet</u>
Conduit Invert	66.0	29	68.5	0
Limits of Government Land	103.0	127,591	95.0	82,921
100-Year Flood (2)	103.8	138,687	97.0	107,363
Standard Project Flood	107.6	193,956	98.3	125,061
Natural ground at end of dam	108.0	199,643	104.0	209,600
Top of dam	121.0	-	113.1	-
CONDUITS	3 gated steel-lined conduits encased in concrete, 10' diameter x 247'-8" long each		3 gated steel-lined conduits encased in concrete, 12' diameter x 131'-11" long each	
STILLING BASIN	59.11' parabolic chute spillway; 54.98' long x 54.00' wide longitudinal stilling basin; 883.63' of pre-cast concrete block/articulating concrete block outlet channel		50.01' parabolic chute spillway; 51.00' long x 57.00' wide longitudinal stilling basin; 856.23' of pre-cast concrete block/articulating concrete block outlet channel	

(1) Elevations are based on the NAVD88 datum.

(2) Provisional until compliant with the USACE Civil Works Review Policy.

I - INTRODUCTION

1-01. Authorization for Manual. This manual is submitted as required by Engineer Regulation (ER) 1110-2-240 "Water Control Management," 30 May 2016 and prepared in accordance with Engineer Manual (EM) 1110-2-3600 "Management of Water Control Systems," 10 October 2017 and ER 1110-2-8156 "Preparation of Water Control Manuals," 30 September 2018.

1-02. Purpose and Scope. The purpose of this manual is to document the Addicks and Barker Reservoir regulation plans, to present detailed information to higher authority, and to give guidance to personnel concerned with or responsible for the regulation of Addicks and Barker Reservoirs during the life of the projects. This manual includes data and information pertinent to the regulation of Addicks and Barker Reservoirs.

The previous manual version, dated November 2012, consolidated the regulatory conditions published in "Hydrology, Buffalo Bayou and Tributaries, Texas, Addicks and Barker Reservoirs, August 1977" with Reservoir Regulation Schedules published in "Reservoir Regulation Manual for Addicks and Barker Reservoirs, April 1962." This manual updates reservoir regulation for the new outlet works constructed at both Addicks and Barker Reservoirs, which have a different geometry than the previous outlet works. Additional pertinent data and reports are also incorporated into this manual and are listed in Table 1-01 in the Supplementary Tables at the end of this manual.

1-03. Related Manuals and Reports. Reports and manuals pertinent to Addicks and Barker Reservoirs are listed in Table 1-01, Page T1.01-01, in the Supplementary Tables at the end of this manual.

1-04. Project Owner. Addicks and Barker Reservoirs are owned by the United States Government.

1-05. Operating Agency. The U.S. Army Corps of Engineers (USACE) is the operating agency for Addicks and Barker Reservoirs. The Project Operations Branch, Galveston District office has the responsibility for operation of Addicks and Barker Reservoirs. The Damtender (Natural Resource Management Specialist) for Addicks and Barker Reservoirs has the responsibility for the specific operations of Addicks and Barker Reservoirs. The project is manned and operated from 0730 hours to 1600 hours on weekdays throughout the year, and manned operation can vary up to 24 hours a day depending on the elevation status of the reservoirs and/or any dam safety concerns as well. Reference "Emergency Action Plan, Addicks Reservoir and Barker Reservoir, Annex I to Galveston District Emergency Operation Plan," Completion Date: 22 May 2014, and any subsequent annual updates. The operators work under the supervision

of the Damtender. Gate operations are manually controlled by the operator from the outlet structures using electrically controlled service gates. The Water Management Section/Hydraulics and Hydrology (H&H) Branch is responsible for regulating the conduit gates. The Damtender provides the Chief, Water Management Section/H&H Branch an updated list of project operations personnel, giving their office and personal telephone numbers.

1-06. Regulating Agencies. USACE is the regulating agency for Addicks and Barker Reservoirs. The Water Management Section/H&H Branch in the Galveston District Office is responsible for establishing pool limits, setting water control criteria and objectives, making hydrologic forecasts, and coordinating overall water management operations. The plans and objectives for water control purposes are executed on a real-time basis by the project operating personnel.

1-07. Vertical Datum. The Vertical Datum for the Buffalo Bayou and Tributaries project is the North American Vertical Datum of 1988 (NAVD88). Because the Houston metropolitan region has experienced extreme subsidence, local adjustments have been made to account for subsidence with periodic adjustments. In 2000-2001, the National Geodetic Survey (NGS) ran levels in the region that resulted in Harris-Galveston County Subsidence District (HGCS D) to update their control network reflecting updated elevations in 2002-2003 using fast static Global Positioning System (GPS) (NAVD88 geoid99, NAD83 1997.00 epoch). This network adjustment was constrained to multiple Continuously Operating Reference Stations (CORS) with extensometers on site (Lake Houston CORS ARP, Northeast 2250 CORS ARP, and Addicks 1795 CORS ARP). Once this network was completed, HGCS D applied a .253-foot shift due to elevation changes to CORS "Northeast 2250 CORS ARP." Previous versions of this manual referred to this shift as "NAVD88 adjustment 2001." Project elevations have not been updated since this adjustment, and elevations in this water control manual are based on previous publications. Future updated elevations should be referenced with a year the survey was completed with the datum used and geoid, if applicable.

II - DESCRIPTION OF PROJECT

2-01. Location. The Buffalo Bayou watershed is within the San Jacinto River Basin and lies primarily in Harris and Fort Bend Counties in southeast Texas. Barker Dam is located on Buffalo Bayou, and Addicks Dam is located on South Mayde Creek, a tributary of Buffalo Bayou. Both dams are located on the northwestern boundaries of the city limits of Houston, Texas. The top of dam at the outlet works of Addicks Reservoir are located at approximate latitude 29.791111° and longitude -95.623333°. The top of dam at the outlet of Barker Reservoir is located at approximate latitude 29.769722° and longitude -95.646944°. An overall vicinity map is shown on Plate 2-01.

2-02. Purpose. Addicks and Barker Reservoirs contribute to the overall purposes of authorized Buffalo Bayou flood risk management projects, which include the flood risk management protection provided to the City of Houston from flood damages. As a result of providing flood risk management downstream of Addicks and Barker Reservoirs, a benefit from this Risk Reduction is the prevention of excessive channel velocities and silt deposits accumulating in the Houston Ship Channel Turning Basin. The two reservoirs provide floodwater detention for flood risk management on the Buffalo Bayou watershed, and except during periods of rainfall, do not normally impound significant water.

2-03. Physical Components. Addicks and Barker Reservoirs are similar structures, consisting of long earthen embankments, with each dam having three conduits discharging flood waters into downstream channels. Subsidence has occurred along the dams and at the outlet works since construction to varying degrees. All elevations, unless otherwise noted, are NAVD88. The following paragraphs describe the physical components of the reservoir projects:

- a. Addicks Dam. The reservoir is formed by an earthen dam approximately 61,166 feet long constructed with 1 on 3 side slopes on the upstream and 1 on 2.5 side slopes on the downstream with a maximum height above stream bed of 48.5 feet. Both the upstream and downstream slopes are sodded, and a 12-foot wide, flexible road surface extends along the crest of the dam. The top of the dam is at elevation 121.0 feet, and the ends of the dam embankment terminate at a ground elevation of 108.0 feet on the north end and elevation 112.0 feet on the west end. The spillway consists of two emergency spillways at both ends of the dam. Page iii shows a local aerial map for Addicks Reservoir. Plate 2-02 shows typical sections for Addicks Dam.
- b. Addicks Outlet Works. The outlet works consist of an intake tower, trash rack structures, three 10.0 foot diameter circular steel lined conduits encased in concrete that extend 247 feet – 8 inches through

the embankment. Each conduit has an invert elevation of 66.0 feet and an exit elevation of 65.0 feet. After exiting the conduits the flows then drop into a parabolic spillway and exits the stilling basin at elevation 51.0 feet. Discharge through the conduits passes through an approximately 59 foot parabolic spillway and into a 55 foot long by 54 foot wide longitudinal stilling basin, then through a 883.63 foot long pre-cast and articulating concrete block lined outlet channel emptying into South Mayde Creek. Plate 2-04 shows a plan and profile view of the Addicks Outlet works.

- c. Barker Dam. The reservoir is formed by an earthen dam approximately 71,900 feet long constructed with 1 on 3 side slopes on the upstream and 1 on 2.5 side slopes on the downstream with a maximum height above stream bed of 36.5 feet. Both the upstream and downstream slopes of the dam are sodded, and a 12-foot wide, flexible road surface extends along the crest. The top of the dam is at elevation 113.1 feet, and both ends of the dam embankment terminate at a ground elevation of 104.0 feet. The spillway consists of two emergency spillways at the ends of the dam. Page iv shows a local aerial map for Barker Reservoir. Plate 2-03 shows typical sections for Barker Dam.
- d. Barker Outlet Works. The outlet works consist of an intake tower, trash rack structures, three 12.0 foot diameter circular steel lined conduits encased in concrete that extend 131 feet – 11 inches through the embankment. Each conduit has an invert elevation of 68.5 feet and an exit elevation of 67.5 feet. After exiting the conduits the flows then drop into a parabolic spillway and exits the stilling basin at elevation 55.0 feet. The conduits are controlled by means of rectangular, electrically-operated 12-foot by 12-foot service gates. Discharge through the conduits passes through an approximately 50 foot parabolic spillway and into a 51 foot long by 57 foot wide longitudinal stilling basin, then through an 856.23 foot long pre-cast and articulating concrete block lined outlet channel emptying into Buffalo Bayou. Plate 2-05 shows a plan and profile view of the Barker Outlet works.

2-04. Related Control Facilities. Addicks and Barker Reservoirs serve in conjunction with approximately 7.4 miles of Buffalo Bayou channel improvements immediately downstream of the dams to provide flood protection along Buffalo Bayou. Construction of additional downstream channel improvements along Buffalo Bayou were authorized by the Flood Control Act of 1954, but this construction was never performed due to public opposition concerned with aesthetic and environmental effects to Buffalo Bayou and the rapid development of the area.

2-05. Real Estate Acquisition. Fee simple title has been obtained on approximately 12,460 acres for Addicks Reservoir and 12,060 acres for Barker

Reservoir. Property limits are defined by elevation 103.0 for Addicks Reservoir and elevation 95.0 for Barker Reservoir, based on NAVD88 elevations.

2-06. Public Facilities.

- a. Addicks Reservoir. Public facilities at Addicks Reservoir are Bear Creek Pioneer Park, Cullen Park, Congressman Bill Archer Dog Park, a community center, sports fields for soccer and baseball, cycling park, golf course, and jogging trails, etc. Public facility areas are shown on Plate 2-06.
- b. Barker Reservoir. Public facilities at Barker Reservoir are George Bush Park, Millie Bush Dog Park, as well as other facilities catering to Little League baseball, soccer fields, sports shooting sites, model airplane fields, and hiking trails, etc. Public facility areas are shown on Plate 2-07.

III - HISTORY OF PROJECT

3-01. Authorization of Project. Addicks and Barker Dams were authorized under the Rivers and Harbors Act of June 20, 1938, House Document No. 456, 75th Congress, 2nd Session, which authorized flood control work in the Buffalo Bayou watershed. The project was further modified by the Flood Control Acts of August 11, 1939, September 3, 1954, and October 27, 1965. The Flood Control Act of 1954, House Document No. 250, 83rd Congress, 2nd Session, authorized the straightening, enlarging, and lining, where necessary, on Buffalo, Brays, and White Oak Bayous.

The existing project, as authorized, provides for flood risk management, to include the protection of the City of Houston from flood damages. The authorized benefits of detention reservoirs, channel improvements, and diversionary projects should help in preventing excessive velocities and silt deposition in the Houston Ship Channel's turning basin.

3-02. Planning and Design. The original flood control project for the main stem of Buffalo Bayou was authorized for the purpose of protecting urban development along Buffalo Bayou through the City of Houston. Its authorization was prompted by devastating floods in 1929 and 1935.

Initial planning and design for Addicks and Barker Reservoirs were based on the Definite Project Report for Buffalo Bayou, dated June 1940. The construction of the Barker Dam's original outfall structure and outlet channel was started in February 1942 and completed in February 1945. The construction of the Addicks Dam's original outfall structure and outlet channel was started in May 1946 and completed in December 1948. The original Barker Outfall structure and outlet channel were completed in 1945. The original Addicks Outfall structure and outlet channel were completed in 1948. The original design of each of the outfalls included five box culvert conduits, with one conduit gated and the other four uncontrolled. As the construction of the gates neared completion in 1948, gates were installed on two of the four uncontrolled conduits at each reservoir. Gates were added to the remaining conduits in 1962 and 1963.

Several repairs were made to the outlet works at both Addicks and Barker dams since their completion. These repairs were primarily due to the silty and sandy erodible foundation soils underlying the conduits. A summary of these past repairs consist of: foundation erosion repairs during construction, parabolic chute cavity repair in 1968, additional repairs to the cantilever wall at Addicks Dam in 1973, outlet work repairs at Addicks in 1979, and outlet work repairs at Barker in 1982.

Seepage control measures were incorporated at both projects due to seepage concerns that were discovered in 1977. Potential seepage and piping is associated with erodible foundation soils and increased storage durations caused by gated operations. These measures included the construction of a soil bentonite slurry trench through the embankment (not including the area beneath the outlet conduits) and pervious foundation, placement of a downstream berm to enhance slope stability, and placement of clay blankets to thicken the impervious cover over pervious foundation materials. This work was accomplished between 1977 and 1982.

As a result of provisions contained in the Dam Safety Assurance Program (DSAP), Addicks and Barker Dams were modified to conform to updated design criteria between 1986 and 1989. Remedial work consisted of two primary features. First, the main dam was raised to achieve needed freeboard requirements. Raising the tops of the dam embankments was not practical at the outlet works on both dams since this would have required steeper side slopes to compensate for the fixed dam width corresponding to the length of the outlet works. Therefore, concrete T-walls (parapet walls) were constructed along the tops of the original embankments at the outlet works. Second, erosion protection utilizing roller compacted concrete was added to the lower ends of the dams so they could serve as overflow spillways during storms greater than the Standard Project Flood (SPF), up to and including the Probable Maximum Flood (PMF).

Several issues within and around the conduits have led to recent repairs. These issues include erodible foundation soils, 'window' areas of the bentonite cutoff walls adjacent to the conduits, open conduit joints, cracks within the parabolic chutes, and lack of engineered filters. All of these factors have led to the formation of voids beneath the conduits and parabolic chutes on both reservoirs.

In 2009, 176 cubic yards of polyurethane was placed beneath the conduits and top of the parabolic chute at Addicks and 340 cubic yards was placed at Barker. This work was done under an Urgent and Compelling contract during high pools to ensure the conduits were stable for the required releases. In 2010, with the assistance and oversight of the United States Bureau of Reclamation (USBR), another contract was awarded to inject cementitious grout beneath the stilling basin, parabolic chutes, and conduits at both dams. These efforts were performed to insure that the foundations under the outlet structures were tight with no voids. A total of 17.8 cubic yards of Portland cement grout was pumped into voids beneath and along the outlet works conduits and parabolic chute at Addicks Dam. A total of 45.3 cubic yards was pumped beneath and along the conduits and parabolic chute at Barker Dam.

During grouting operations in the upstream portions of the conduits at Barker Dam, relatively large amounts of cement grout surfaced at two upstream locations near the embankment toe. Subsequent investigations revealed this exposed grout had flowed from the conduit injection points through the interface between

the excavation for the outlet works and the backfill and along the interface between the stripped foundation and the dam embankment. Cement grout was placed with sufficient pressure to force migration of grout through soft and loose soil zones within and below the embankment. These loose zones most likely existed prior to grout placement but were probably widened and fractured during this effort. In any event, it is evident that damage occurred and a poor foundation condition exists within and below the embankment.

In 2011, as a result of the Dam Senior Oversight Group (DSOG) categorizing the Addicks and Barker dams as a Dam Safety Action Classification (DSAC) I (urgent and compelling: unsafe), a dam safety modification study (DSMS) was performed and completed in May 2013. Granular filters were designed and constructed as Interim Risk Reduction Measures (IRRM) while the study was ongoing. Each granular filter is a sand filter constructed along the sides of the conduits and along the top of the conduits. The filter extends upstream from the conduit headwall for about eight feet, and the filter is four feet wide at the sides of the conduits. The filter was placed three feet thick over the tops of the conduits at Addicks Dam and two feet thick over the tops of the conduits at Barker Dam. The recommended alternative of the DSMS was to replace the outlet works structures and abandon the existing outlet works structures in-place at both reservoirs. The design for the new outlet works was completed in June 2015.

Subsequent project-related reports and Design Memoranda are listed in Table 1-01, which is included as a supplementary table in the back of this report.

3-03. Construction. A history of construction activities for Addicks and Barker Reservoirs is presented in Table 3-01.

TABLE 3-01
HISTORY OF CONSTRUCTION ACTIVITIES

Activity		Addicks	Barker
Reservoir Conduits and One Gate	(Start)	May 1946	Feb 1942
	(Complete)	Dec 1948	Feb 1945
Date of Initial Operation	(Start)	Jun 1948	Aug 1945
Two Additional Conduit Gates	(Start)	Feb 1948	Feb 1948
	(Complete)	Apr 1949	Apr 1949
Two Remaining Conduit Gates	(Start)	Jan 1962	Jan 1962
	(Complete)	Feb 1963	Feb 1963
Parabolic Chute Cavity Repair	(Start)	1968	1968
	(Complete)	1968	1968
Cantilever Wall Repair	(Start)	1973	N/A
	(Complete)	1973	N/A
Emergency Seepage Control	(Start)	Sep 1977	Sep 1977
	(Complete)	Aug 1979	Sep 1979
Raise Main Embankment	(Start)	Jul 1986	Jun 1986
	(Complete)	Aug 1987	Aug 1988
Armor Plate Ends of Dam w/RCC	(Start)	May 1987	May 1987
	(Complete)	Sep 1988	Sep 1988
T-wall Contract at Outlet	(Start)	Dec 1988	Sep 1989
	(Complete)	Sep 1989	Jun 1991
Outlet Structure Renovations (Electrical Work and Gate Repairs)	(Start)	1998	1998
	(Complete)	1999	1999
Fill Voids Under Conduits Phase 1	(Start)	May 2009	May 2009
	(Complete)	May 2009	May 2009
Fill Voids Under Conduits Phase 2	(Start)	Mar 2010	Mar 2010
	(Complete)	Apr 2010	Apr 2010
Granular Filter	(Start)	2010	2010
	(Complete)	2010	2010
Stabilize Uplift at End of Parabolic Chute Slab	(Start)	2013	2014
	(Complete)	2013	2014
New Outlet Works, Cutoff Wall, and Existing Outlet Works Abandonment	(Start)	Aug 2015	Aug 2015
	(Complete - Estimated)	April 2020	April 2020

3-04. Related Projects. The original Federally authorized flood control plan for the City of Houston provided for three detention reservoirs (Addicks, Barker, and White Oak). A system of canals was to convey releases from White Oak Reservoir, north of Houston, to the San Jacinto River and from Addicks and Barker Reservoirs, south of Houston, to Galveston Bay. Also, a levee was to be constructed along the Cypress Creek divide to prevent overflow from the Cypress Creek watershed into Addicks Reservoir. The original design concept for the dams provided for five outlet conduits at each dam, with four of the five to be uncontrolled.

Construction of Barker Dam was initiated in February 1942 and completed in February 1945. During preconstruction planning for Addicks Dam, it was determined more economical to increase the capacity of Addicks Reservoir to accommodate the overflow from Cypress Creek and delete the authorized levee.

Construction of Addicks Dam was initiated in May 1946 and completed in December 1948. Also, rectification and enlargement of approximately 7.4 miles of the Buffalo Bayou channel immediately downstream of the dams was completed in 1948. However, during construction of Addicks Dam, it was recognized that the planned discharge canals would be delayed because of rapid development in the Houston area. Therefore, in order to provide limited protection downstream on Buffalo Bayou until problems with the discharge canals could be resolved, gates were installed on two of the four uncontrolled conduits at each reservoir.

A review of reports completed in 1952 concluded that rising land costs and rapid development made construction of White Oak Reservoir and the discharge canals impracticable, and, in lieu of these facilities, recommended channel rectification of Buffalo, Brays, and White Oak Bayous. These improvements were subsequently authorized by the Flood Control Act of 1954. The plan envisioned straightening and enlarging the channels to contain the SPF with concrete lining to the level of the 10-year frequency flood. It was rationalized at the time that since the reservoirs provided a measure of flood protection for Buffalo Bayou, priority would be placed on channel rectification of Brays and White Oak Bayous. Channel improvements for 25.4 miles of Brays Bayou and 10.7 miles of White Oak Bayou were completed in 1971 and 1975, respectively. However, rectification of Buffalo Bayou was delayed by public opposition concerned with aesthetic and environmental effects of the plan on the existing stream.

3-05. Dam Safety History/Issues. While the gating of two previously uncontrolled conduits on both projects in 1963 made it possible to reduce downstream flooding, it also prolonged storage of rainfall runoff behind the dams and resulted in a serious seepage problem through pervious sections of the embankments and foundations. This seepage problem threatened the stability of the embankments and created a potential for failure of the dams in the event of a high reservoir pool. Repairs for various reaches of the embankments included a bentonite slurry

trench seepage barrier extending through the earth fill dams into the relatively imperious clay strata, earthen stability berms placed on the downstream slope of the embankments, and upstream clay blanketing. These emergency modifications were completed between 1977 and 1982 at a cost of approximately \$12 million for both reservoirs.

As a result of provisions contained in the DSAP, Addicks and Barker Dams were modified to conform to updated design criteria between 1986 and 1989.

Several factors within and around the conduits have led to recent repairs. These include: erodible foundation soils, 'window' areas of the bentonite cutoff walls adjacent to the conduits, open conduit joints, cracks within the parabolic chutes, and lack of an engineered filters. Grouting was performed in 2009 and 2010 in an effort to fill many of the voids.

In 2011, as a result of the DSOG categorizing the Addicks and Barker dams as a DSAC I (urgent and compelling: unsafe), a DSMS was funded. IRRM Plans were developed for both Addicks and Barker dams in February 2010 and April 2013 while long-term remedial measures were pursued. Risk reduction measures at both projects included coordinating the emergency action plan with local authorities, installing a reservoir regulator alarm system for stage and rainfall reporting, and installing outlet conduit monitoring instrumentation and enhanced lighting. The risk reduction measures also included conducting risk communications with the public, developing an interim reservoir control action plan, updating the emergency action plan, and filling voids under conduits. Other risk reduction measures implemented at Barker Dam only included replacing an outlet structure gate and implementing a normal operational flow restriction. Other risk reduction measures implemented at both projects included constructing a granular filter, lacing inspection plugs, grouting outlet works conduit joints, and stabilizing the uplift at the end of parabolic spillway.

The DSMS was completed in May 2013 and recommended to replace the outlet works structure and abandon the existing outlet works structure in-place. Design was complete in June 2015, and the current ongoing construction contract was awarded in August 2015 for approximately \$75M with a projected scheduled completion date of April 2020.

3-06. Principal Regulation Problems. The chief regulation problem associated with Addicks and Barker Reservoirs has been the continually diminishing downstream non-damaging channel capacity due to encroachment. Additionally, continual upstream development has increased inflow into the Reservoirs due to these developments and is likely to continue. Plates 3-01 and 3-02 display water surface profiles and floor elevations along Buffalo Bayou downstream of the reservoirs. In 1972, releases from the reservoirs, when combined with uncontrolled runoff and outflow from Addicks and Barker Reservoirs, were limited to 2,000 cfs due to embankment problems and continued development. This is

the principal regulation issue that constrains the downstream releases. Over the last ten years, surveys and observations along the bayou have determined that the present non-damaging channel capacity is approximately 4,000 cfs. A Section 216 review of completed projects is included in the scope of the ongoing Buffalo Bayou and Tributaries Resiliency Study, and this manual will be updated with results from the study after it is reviewed and approved.

Additional regulation problems include seepage and boils infiltrating the embankments. While the gating of two previously uncontrolled conduits on both projects in 1963 made it possible to reduce downstream flooding, it also prolonged storage of rainfall runoff behind the dams and resulted in a serious seepage problem through pervious sections of the embankments and foundations. This seepage problem threatened the stability of the embankments and created a potential for failure of the dams in the event of a high reservoir pool. Repairs for various reaches of the embankments included a bentonite slurry trench seepage barrier extending through the earth fill dams into the relatively imperious clay strata, earthen stability berms placed on the downstream slope of the embankments, and upstream clay blanketing. These emergency modifications were completed between 1977 and 1979 at a cost of about \$12 million.

3-07. Modifications to Regulations. The original design concept for both dams provided for four of the five outlet conduits to be uncontrolled, permitting a combined uncontrolled discharge of about 15,700 cfs into Buffalo Bayou. When two of the four ungated conduits were gated at each dam in 1948, the combined uncontrolled discharge was about 7,900 cfs, which was considered to be the channel capacity at that time. Increasing urban development adjacent to Buffalo Bayou during the 1940's and 1950's created a potential flood threat by the uncontrolled release from the reservoirs. Studies undertaken in 1960 showed the feasibility of gating the remaining uncontrolled conduits, and this work was subsequently completed in 1963. The total of all releases, plus local runoff downstream from the dams, would start at 4,000 cfs and be gradually increased to 6,000 cfs except under emergency conditions. While the gating of the last two uncontrolled conduits on both projects in 1963 made it possible to reduce downstream flooding, it also prolonged storage of rainfall runoff behind the dams.

Continued residential development along Buffalo Bayou downstream from the reservoirs resulted in channel encroachment, and by late 1970, flows in excess of 3,000 cfs in the unimproved channel downstream of the dams would begin to threaten the first floor elevations of some residences. Even without significant downstream inflows, release rates of 2,500 to 2,800 cfs would produce prolonged nuisance type flooding of flower beds, trees, and lawns for a considerable number of residences adjacent to the Bayou and in some of its tributary swales. Discharges in this range do not leave any freeboard for inflows from rainfall. In early 1971, an inspection of Buffalo Bayou revealed serious bank erosion at several locations. In order to provide temporary relief from this problem, until the

local interests could provide the necessary remedial measures, releases from the reservoirs were temporarily restricted to 500 cfs at Piney Point. During dry periods with little or no chance of rain, releases could be made from 700 to 1,000 cfs. When rainfall was expected, releases had to be reduced or shut off entirely.

The reduction in release rates and the resulting prolonged detention of water in the reservoirs generated a number of complaints from local residents during the latter part of 1971. The complaints generally referred to the floodwaters that were stored in the reservoirs and expressed concern that the reservoirs were becoming breeding grounds for mosquitoes and that the prolonged storage would kill the trees and make the area unfit for parks sites. The Galveston District received complaints of an undesirable odor due to the prolonged detention of floodwaters in the wooded areas at the Addicks Outlet Works when releases were being made.

A study was started in 1971 and completed in 1972 revising the regulation procedures to maintain the best balance of reservoir releases into the inadequate downstream channel without serious damage as opposed to the prolonged storage of water in the reservoirs. The interim procedures described herein were put in place until local interests were able to complete their improvements. These improvements as planned were expected to permit total releases from the reservoirs of 2,000 to 2,500 cfs. Based on the available data at the time and new field surveys, the anticipated operational procedure with the local channel improvements was determined to permit releases of 2,000 cfs. In 1974, local interests completed improvements to the channel in areas which extensive damage to adjacent structures was threatening. Regulation procedures were implemented to allow combined releases of Addicks and Barker Dams up to 2,000 cfs at Piney Point, local inflow included.

In early 1976, the Harris County Flood Control District (HCFCD) excavated Turkey Creek Ditch adjacent to Federal property downstream of Addicks Dam. The ditch, about 15 feet deep, intercepted and exposed a sand stratum that was believed to be continuous through pervious sections of the dam embankments foundation that opened to the surface of the pool area. During subsequent rises in the reservoir pool, seepage was noted in the exposed sand strata in the ditch. This was considered to be a serious seepage problem that threatened the stability of the embankment and created a potential for failure of the dam in the event of a high reservoir pool. Immediate action was taken to fix the problem. Since Barker Reservoir had Barker and Clodine Ditches below its dam, the repairs for Addicks Dam were implemented on Barker Dam also. These repairs for the various reaches of the embankments included a bentonite slurry trench seepage barrier extending through the earth fill dams into the relatively impervious clay strata, earthen stability berms placed on the downstream slope of the embankments, and upstream clay blanketing. Emergency modifications were completed between 1977 and 1979.

In 1976, a restudy of Addicks and Barker Reservoirs was initiated to determine the adequacy of the two dams with respect to safety and functional reliability. On 8 May 1977, the Hydrology Report for Addicks and Barker Reservoirs was submitted and later approved by Southwestern Division. In this report, Exhibit D, titled "Description of Addicks and Barker Reservoirs Regulation Program," Section D-5, Regulatory Conditions, modified the flood risk management regulations for each reservoir. Since that report, the flood risk management regulations have remained the same up until the construction of the new outlet works. The regulation procedures stipulated that releases from both reservoirs, plus the downstream inflow, will not exceed 2,000 cfs at Piney Point on Buffalo Bayou except under emergency conditions. Over the last ten years, surveys and observations along the bayou have determined that the present non-damaging channel capacity is approximately 4,000 cfs. During the construction of the new outlet works, a temporary deviation was approved by Southwestern Division to allow releases from both reservoirs, plus the downstream inflow, up to a flow rate of 4,000 cfs at Piney Point on Buffalo Bayou. This deviation allowed releases of up to 3,000 cfs during Stage 1 Extended Watch and 4,000 during Stage 2 Extended Watch, as defined by the Emergency Action Plan.

IV - WATERSHED CHARACTERISTICS

4-01. General Characteristics.

- a. Buffalo Bayou Watershed. Buffalo Bayou is located in the San Jacinto Watershed Basin. The Buffalo Bayou watershed lies primarily in Harris and Fort Bend Counties in southeast Texas. The basin is bounded on the north by Cypress Creek; on the east by the San Jacinto River; on the south by Clear Creek; and on the west by the Brazos River. Buffalo Bayou travels through heavily wooded residential areas and flows east through downtown Houston, draining a 102 square mile watershed by the time it reaches the Houston Ship Channel. Barker Dam is located on Buffalo Bayou about 1.5 miles upstream of the confluence of South Mayde Creek. Addicks Dam is located on South Mayde Creek about one mile upstream of its confluence with Buffalo Bayou.
- b. Barker Reservoir Watershed. The portion of the Buffalo Bayou watershed flowing into Barker Reservoir lies within Harris, Waller, and Fort Bend Counties. The watershed, a roughly trapezoidal area of approximately 130 square miles, is approximately 23 miles long with an average width of 6 miles. The watershed is shown on Plate 4-01.
- c. Addicks Reservoir Watershed. The South Mayde Creek watershed flowing into Addicks Reservoir lies within Harris County. The watershed is roughly 15 miles long, 10 miles wide, and has a drainage area of approximately 136 square miles. The watershed includes several major tributaries including Bear Creek, Langham Creek, Horsepen Creek and Turkey Creek. The watershed is shown on Plate 4-01.
- d. Cypress Creek Watershed. The 130 square mile watershed of Cypress Creek upstream of U.S. Highway 290 lies north of and adjacent to the Addicks Reservoir watershed. The general land slope of Harris and Waller Counties in this area is in a southerly direction while the Cypress Creek channel flows in an easterly direction to its outlet into the San Jacinto River in eastern Harris County. Consequently, the flood plain for Cypress Creek is relatively shallow with a poorly defined divide to the south and floodwaters from larger floods flow southward into the Addicks Reservoir watershed. The watershed is shown on Plate 4-01.

4-02. Topography. Natural ground elevations in the Addicks and Barker Reservoir watersheds vary from approximately 200 feet at the upstream divides to approximately 68 feet at Addicks Dam and approximately 70 feet at Barker Dam. Natural stream flow gradients in the basin are very uniform at about 5 feet per mile sloping in a southeastern direction.

4-03. Geology and Soils. The geologic formations which outcrop on the Buffalo Bayou watershed are of the Quaternary system. The southeastern part of the basin is occupied by Beaumont clay, and the northeastern part by Lissie sands. Recent alluvium deposits occupy the shallow stream valleys. The formations dip southeasterly in the same direction at the land surface, but on a much steeper slope. The soils are of the Coastal Prairie series and generally drain poorly.

- a. Addicks Dam. The existing embankment materials are typically stiff to hard sandy clays with thin layers, seams, and pockets of silty sands, clayey sands, and sandy silts. The existing embankment is founded on a layer of stiff to hard sandy clays and clays varying in thickness from 8 to 30 feet. The sandy clays overlie a medium dense to very dense layer of silty sand, clayey sand, or sandy silt. The thickness of this layer varies considerably from a few feet to 60 feet. In some reaches of the embankment the layer was not encountered. Deeper materials are very stiff to hard clays with some sandy silt or clayey silt layers.

During the period of September 1977 to March 1979, approximately 6.8 miles of the existing embankment were modified by remedial seepage control construction. Under the first contract, a soil-bentonite slurry trench was constructed through the embankment and pervious foundation along approximately 1.57 miles of the embankment to prevent possible piping failure through the dam foundation. With the second contract, the slurry trench was extended along an additional 1.9 mile segment of the embankment; 0.47 mile of slurry trench along the upstream toe of the embankment was constructed; and approximately 0.9 mile of stability berm was constructed along the downstream slope. An additional 1.39 miles of upstream slurry trench and 2.38 miles of downstream stability berms were constructed under the third contract. The total length of remedial work was 6.8 miles or 58.6 percent of the length of the dam. Work under the fourth contract was restricted to improvement of seepage control measures at the outlet works. The work included placement of well screens in weep holes in the outlet works structure to control loss of underlying pervious material; installation of capped inspection holes in the parabolic chute slab to allow monitoring of the loss of pervious foundation material; and installation of relief wells in the pervious materials adjacent to the outlet works. Reaches where slurry trenches and downstream stability berms were constructed, and details of the construction are given in the Emergency Seepage Control Construction Completion Report, Buffalo Bayou and Tributaries, Addicks and Barker Dams, Texas, March 1983 and the Addicks and Barker Dam Safety Modification Report, May 2013.

In 1986, approximately 23,600 linear feet of the main earth embankment of Addicks Dam was raised about 1 to 2 feet to the minimum freeboard elevation of 121 feet NAVD88 and approximately

8,800 linear feet was raised about 3 feet to the computed freeboard elevation of 121 feet NAVD88. This generally was accomplished by the addition of compacted fill on the downstream slope and crown of the embankment. The compacted fill was composed of sandy clays and clayey sand material excavated from borrow areas within the reservoir. The downstream slope of the enlarged embankment was resurfaced with the existing topsoil materials suitable for establishing turf. A portion of the flexible base material on the existing crown was reused in constructing the open surfaced roadway on the new 12-foot wide crown. The enlarged main embankments generally have side slopes of 1 vertical to 3 horizontal on the upstream side and 1 vertical to 2.5 horizontal on the downstream side. Exceptions to the 1 vertical to 3 horizontal upstream slope occurred on Addicks Dam between stations 160+00 and 235+00 and between stations 380+00 and 460+00 where the existing embankment crest was approximately 1.0 foot below the crest of the proposed embankment. In these reaches, the side slope on the upstream side would be 1 vertical to 2.5 horizontal to allow reshaping of the existing crown with minimal disturbance to the upstream and downstream side slopes.

- b. Barker Dam. The existing embankment materials are typically stiff to hard sandy clays with thin layers, seams, and pockets of silty sands, clayey sands, and sandy silts. The existing embankment is founded on a layer of stiff to hard sandy clay varying in thickness from 7 to 25 feet. The sandy clays overlie a medium dense to very dense layer of silty sand, sandy silt, or clayey sand. The thickness of this layer varies from a few feet to 35 feet. In some reaches of the embankment the sandy layer was not encountered. Deeper materials are predominantly very stiff to hard clays with some sandy silt or clayey silt layers.

Approximately 9.1 miles of the existing embankment was modified by remedial seepage control construction in 1978 through 1982. Under the first contract, a soil-bentonite slurry trench was constructed through the embankment and pervious foundation along approximately 1.9 miles of the embankment to prevent possible piping failure through the dam foundation. In adjacent lengths, a downstream berm was constructed under the second contract along approximately 7.2 miles of the embankment to improve stability of the downstream slope under steady seepage conditions. Also under the second contract, clay blankets were constructed in the upstream borrow areas in three segments to thicken the impervious cover over the pervious foundation materials. Under the third contract, relief wells were installed in the stilling basin and joints were sealed in the outlet works conduits. Reaches where slurry trenches and downstream stability berms were constructed, and details of the construction are given in the Emergency Seepage Control Construction Completion Report, Buffalo Bayou and Tributaries, Addicks and Barker

Dams, Texas, March 1983 and the Addicks and Barker Dam Safety Modification Report, May 2013.

In 1986, approximately 14,800 linear feet of the main earth embankment on Barker Dam was raised about 2 to 3 feet to the minimum freeboard elevation of 113.1 feet NAVD88, and approximately 42,750 linear feet was raised about 3 to 5 feet to varying computed freeboard elevations up to 113.1 feet NAVD88. This generally was accomplished by the addition of compacted fill on the downstream slope and crown of the embankment. The compacted fill was composed of sandy clays and clayey sand excavated from borrow areas within the reservoir. The downstream slope of the enlarged embankment was resurfaced with the existing topsoil materials suitable for establishing turf. A portion of the flexible base material on the existing crown was reused in constructing the open surfaced roadway on the new 12-foot crown. The enlarged main embankments generally have side slopes of 1 vertical to 3 horizontal on the upstream side and 1 vertical to 2.5 horizontal on the downstream side.

- c. Groundwater Conditions. Water table measurements were made in some of the borings taken prior to remedial seepage control construction. The measurements indicated a water table existed 5 to 15 feet below natural ground along Addicks Dam and 5 to 25 feet below natural ground along Barker Dam.
- d. Subsidence. The geologic area has experienced large regional subsidence due to groundwater extraction which continues today albeit at a decreased rate in recent years due to restrictions on groundwater extraction. Although the regional subsidence in the Barker area appears to be evenly distributed over the region, there could be localized differential settlement around the conduit and the soils (CL/CH) are compressible.

4-04. Sediment. Subsequent to project completion and through the 1973-1975 reservoir re-surveys, there has been no evidence of appreciable erosion in the watersheds upstream of the dams or serious sedimentation problems. Since 1975, construction activities associated with urbanization of the upper watersheds have substantially increased the sediment load of the streams flowing into the reservoirs. As a result of the Galveston District's policy established in the late 1970's of prohibiting drainage improvements on the Government-owned reservoir lands, sediment deposits have been restricted to the improved channels on privately- owned land and to the shallow overbanks of the upper elevations of the reservoirs. In 1981, the Galveston District relaxed the drainage policy regarding improved channels with the requirement of positive sediment control upstream of improved channel reaches on Government-owned lands. Reference Exhibit B for a copy of the letter submitted to Harris County communicating this

change in policy. Sediment ranges have been set up upstream of the Government-owned lands and within the reservoir area to monitor Harris County and Fort Bend County sediment basin operation and maintenance programs on channel improvements brought onto government-owned land.

4-05. Climate.

- a. General. The Buffalo Bayou watershed lies in a relatively humid and temperate climatic region. Summers are long and hot but are tempered somewhat by sea breezes from the Gulf of Mexico. Winters are generally mild, and snowfall is infrequent. Prevailing winds are from the south or southeast.
- b. Temperature. The daily range in temperatures is moderate except in the winter months when polar air masses periodically cause sharp drops. The average annual temperature for this area is about 70.5 degrees Fahrenheit. Temperature extremes range from 109 degrees (2000 and 2011) to 5 degrees (1940 and 1980) were recorded at various official Houston recording sites. Usually, the major airports are the official sites of these recorded temperatures. Table 4-01 presents climatological data relative to temperature at representative United States Weather Service stations near Addicks and Barker Reservoirs.

TABLE 4-01
TEMPERATURE DATA

	Years of Record Thru 2018	<u>Temperature in Degrees Fahrenheit</u>		
		Mean Annual (1)	Maximum Recorded (2)	Minimum Recorded (2)
Houston (Hobby Airport – HOU)	88	70.3	108	5
Houston (Bush Airport – IAH)	49	69.9	109	7
Sugar Land, TX	18	71.3	108	16

(1) Data Tools: 1981 – 2010 Normals, National Oceanic and Atmospheric Administration, <https://www.ncdc.noaa.gov/cdo-web/datatools/normals>.

(2) Applied Climate Information System, Version 2, National Oceanic and Atmospheric Administration, Regional Climate Centers, <http://scacis.rcc-acis.org/>.

- c. Precipitation. Precipitation in the Addicks and Barker Reservoir area is well distributed throughout the year. Summer precipitation typically results from intense, short, isolated convective cells, while winter and

spring precipitation is generally produced by more widespread frontal events. The area is also affected by torrential rainfall associated with hurricanes and other tropical disturbances. The highest recorded 24-hour precipitation in the Houston area was 42 inches on 25-26 July 1979 (Tropical Storm Claudette) north of Alvin, a national record for that time period. Another intense 24-hour total of 19.58 inches was recorded on 8 June 2001 (Tropical Storm Allison) in Houston Heights. Tropical Storm Allison produced a six-day rainfall in Houston that amounted to 38.6 inches. However, Hurricane Harvey in August 2017 produced a U.S. record rainfall of 60.58 inches near Nederland, Texas over a five-day period (25-29 August 2019). This was the most significant tropical cyclone rainfall even in U.S. history. The highest recorded annual precipitation was 76.6 inches at Katy, Texas in 2017, and the lowest recorded annual precipitation was 21.5 inches in Katy, Texas in 1956. Average monthly and annual rainfall totals for Katy, Texas are presented in Table 4-02.

TABLE 4-02
AVERAGE MONTHLY AND ANNUAL RAINFALL

Month	Average Rainfall (inches) (1)	Addicks (inches) (2)(3)	Barker (inches) (2)(3)
Jan	3.11	4.13	3.28
Feb	2.77	2.90	2.77
March	2.56	2.70	3.20
April	3.64	3.43	3.40
May	4.60	4.24	4.28
June	3.96	4.17	4.21
July	3.10	3.44	3.30
Aug	3.82	3.87	4.08
Sept	4.06	4.40	4.39
Oct	4.08	4.46	4.21
Nov	3.98	3.51	3.49
<u>Dec</u>	<u>3.42</u>	<u>3.43</u>	<u>3.32</u>
Total	42.04	44.68	43.92

(1) Periods of Record (1952-2018) at the National Oceanic and Atmospheric Administration's Global Historical Climatology Network Site, ID USC00414704 in Katy, Texas.

(2) Prior to 2018, average rainfall numbers were derived by weighting various rain gauges in the vicinity.

(3) Starting in 2018, average rainfall numbers were derived by using MetVue to calculate a basin average rainfall using National Weather Service radar data.

- d. Evaporation. Since Addicks and Barker Reservoirs are detention-type reservoirs with only flood pools of short duration, evaporation is not a consideration in their daily regulating operations.

- e. Wind. The mean annual wind speed for the Houston area is 7.6 miles per hour, with the highest wind speed recorded in the area was 84 miles per hour in March 1926.

4-06. Storms and Floods. Major storm events affect Harris County in every month of the year. Harris County is relatively flat and possesses a humid semi-tropical climate making it susceptible to both supercell rainstorms coming from the west or tropical storm events moving up from the Gulf of Mexico.

The maximum known flood on Buffalo Bayou occurred in December of 1935. During this flood, overflow occurred from White Oak Bayou into Buffalo Bayou, and considerable overflow occurred from Buffalo Bayou into Brays Bayou. A peak flow rate of 40,000 cfs was estimated for Buffalo Bayou at Waugh Drive, located about 25 stream miles downstream of the reservoirs. Buffalo Bayou below the intersection of White Oak Bayou, located about 28 stream miles downstream of the reservoirs, had an estimated flow of 53,000 cfs.

Since establishment of stream gaging stations, the maximum flood which has occurred on Buffalo Bayou was that of August 2017 (Hurricane Harvey) when a peak discharge of 32,600 cfs was recorded at Shepherd Drive. The largest combined discharge releases from both reservoir projects occurred in August 2017 (Hurricane Harvey) when a total outflow of 11,400 cfs was estimated. The maximum impoundment in Addicks and Barker Reservoirs occurred in August 2017 when pool elevations reached 109.1 feet and 101.6 feet, respectively. These pools resulted from a total rainfall of over 34 inches over a 108-hour period from 25-29 August 2017. Chapter VIII of this manual contains information on additional major storm events.

4-07. Runoff Characteristics. The Buffalo Bayou basin upstream of Addicks and Barker Dams produces moderate to high runoff. Based upon years of observations, it was found that 1.0 to 2.5 inches of rainfall generally was needed to satisfy initial losses before significant runoff begins. The total contributing drainage area during moderate flood events for Addicks and Barker Reservoirs is 136 and 130 square miles, respectively. Under major flood events, Addicks Reservoir receives about one-third of its total volume from the 130 square mile drainage area of the Upper Cypress Creek Basin. The time of concentration from the period of most intense rainfall for major floods is about 5 to 13 hours for the basin. The volume of runoff (inflow volume) is summarized in the average monthly and annual project flows in Table 4-03.

TABLE 4-03
AVERAGE INFLOW VOLUMES AT ADDICKS AND BARKER
RESERVOIRS RECORDED FOR PROJECT RELEASES (1)

Month	Addicks Monthly Average Inflow Volume (1,000 acre-ft)	Barker Monthly Average Inflow Volume (1,000 acre-ft)
January	9.1	9.5
February	8.9	9.6
March	9.1	9.9
April	12.5	12.0
May	10.8	11.8
June	8.8	8.5
July	7.2	6.8
August	12.2	10.2
September	7.4	8.0
October	9.5	9.2
November	9.1	9.8
December	8.3	8.5
ANNUAL TOTAL	112.8	113.8

(1) Period of Record: 1982 through 2018.

4-08. Water Quality. Addicks and Barker Reservoirs are detention reservoirs with flood pools of short duration; therefore, water quality is not an authorized purpose. However, P.L. 92-500 requires that all federal facilities be managed, operated, and maintained to protect the quality of water and resources through conformance with all applicable federal, state, interstate, and local substantive standards.

4-09. Channel and Floodway Characteristics. The Buffalo Bayou channel downstream of Addicks and Barker Reservoirs remains in a relatively natural state; however, adjacent development has encroached to very near the main channel for several miles downstream of the two projects. Plates 3-01 and 3-02 show water surface profiles for various flows down Buffalo Bayou with first floor slab elevations. Potential flood damage to these properties is the major constraint on releases while bank erosion is also a concern. The primary stream gaging station by which Addicks and Barker Reservoirs are regulated is Buffalo Bayou at Piney Point, approximately 10.7 stream miles downstream of Barker Dam.

Other pertinent stream gaging stations include Buffalo Bayou near Addicks (USGS Station Number 8013500) and Buffalo Bayou at West Belt Drive (USGS Station Number 8073600), approximately 3.0 and 6.5 miles downstream of Barker Dam, respectively. These station locations and other nearby gaging stations are shown in Plate 5-01, and a discharge rating curve for the Buffalo Bayou at Piney Point gage is provided in Plate 4-02.

4-10. Upstream Structures. There are no significant upstream flood control structures on Buffalo Bayou or its tributaries.

4-11. Downstream Structures. There are no significant downstream flood control structures on Buffalo Bayou or its tributaries.

4-12. Economic Data.

- a. Population. Population by county in the vicinity of Addicks and Barker Reservoirs are shown in Table 4-04.

TABLE 4-04
POPULATION OF COUNTIES IN THE
VICINITY OF ADDICKS AND BARKER RESERVOIRS

County	1980 (1)	1990 (1)	2000 (1)	2010 (1)	% Change 2000-2010
Fort Bend	130,962	225,421	354,452	585,375	+65.1
Harris	2,409,547	2,818,101	3,400,578	4,092,459	+20.3
Montgomery	127,222	182,201	293,768	455,746	+55.1
Waller	19,798	23,389	32,663	43,205	+32.3

(1) U. S. Bureau of the Census, Census of Housing and Population.

- b. Agriculture. The Addicks and Barker Reservoir watersheds are approximately 34% and 41% agricultural land-use and land-cover respectively (Yang and others, 2019). The agricultural areas are used primarily for pasture land and general mixed agricultural purposes.
- c. Industry. The Addicks and Barker Reservoir watersheds are approximately 49% and 45% urbanized respectively (Yang and others, 2019), most of which is residential and related commercial and office land use. There is very little heavy industrial development in the Addicks and Barker Reservoir watersheds or in the upper Buffalo Bayou watershed immediately downstream of the two projects.
- d. Recreation. A brief description of public facilities available in these areas is presented in Section 2-06. A detailed description of existing

and proposed public facilities is provided in the latest version of the Addicks and Barker Master Plan.

- e. Flood Damages. Prior to development of the extensive flood control system in the Buffalo Bayou watershed, frequent flooding caused extensive property damage and occasional loss of life. Since the construction of the Addicks and Barker Reservoir projects, flood damages along Buffalo Bayou and its downstream tributaries upstream of White Oak Bayou have been drastically reduced. The flood damage reduction has been accomplished through the progressive reduction in allowable combined discharge for the two projects to accommodate increasing downstream development. Estimated flood damages prevented by Addicks and Barker Reservoirs are shown in Table 4-05 on the following page.

Prior to 2012, “Without Project” flows were determined by lagging the reservoir inflows down the bayou. It was assumed that the inflows would take eight hours to reach the outlet, four more hours to make their way downstream to the USGS gauge at West Belt, and then another four hours to the USGS gauge at Piney Point. The reservoir flows were then added to the flows in the Bayou.

Until Hurricane Harvey stage levels in the bayou were determined by using a 1D RAS model for Buffalo Bayou and calibrating it to the stage/discharge readings from the USGS gauges at Dairy Ashford, West Belt, Piney Point, and Shepherd. Currently, stage levels in the bayou are determined by using a 2D RAS model for the Buffalo Bayou watershed.

The water surface generated by the hydraulic model is then brought into HEC-FIA. The water surface overlays the terrain file and a structure inventory obtained from the local appraisal district to determine a depth of flooding on each structure. HAZUS depth-damage curves are used to assign an approximate dollar value to each structure impacted by the flood event.

The flooding associated with the “Without Project” flows are determined by routing the reservoir inflows down the bayou within the hydraulic model. FIA results are then similarly determined. The final value for Flood Damages Prevented is arrived at by subtracting the losses that were incurred with the project from the losses estimated using “Without Project” Flows.

TABLE 4-05
DAMAGES PREVENTED BY ADDICKS AND BARKER RESERVOIRS
(FY 1980 THROUGH FY 2018)

Fiscal Year (1)	Damages Prevented (\$000) in Actual Dollars (2)
1980	501
1981	17,733
1982	11,700
1983	16,000
1984	0
1985	18,800
1986	25,500
1987	34,792
1988	0
1989	60,434
1990	27,960
1991	22,420
1992	397,600
1993	306,100
1994	289,700
1995	340,000
1996	260
1997	285
1998	478
1999	445
2000	415
2001	24,000
2002	23,300
2003	385,000
2004	194,060
2005	371,953
2006	387,200
2007	801,000
2008	804,200
2009	964,000
2010	762,000
2011	0
2012	544
2013	372,816
2014	1,639,431
2015	2,559,078
2016	5,654,921
2017	8,385,029
2018	513,821
Average	651,628

(1) USACE, Southwestern Division Reservoir Control Center, Annual Water Control Reports.

(2) Fiscal Year includes period of time from October through September.

V - DATA COLLECTION AND COMMUNICATION NETWORKS

5-01. Hydrometeorological Stations.

- a. Facilities. USACE, National Weather Service (NWS), and United States Geological Survey (USGS) cooperate in the collection and dissemination of hydrologic data related to Addicks and Barker Reservoirs. The locations of gaging stations used to regulate Addicks and Barker Reservoirs are shown on Plate 5-01. These stream gaging stations essential to the operation of Addicks and Barker Reservoirs are shown in Table 5-01.

TABLE 5-01
STREAMGAGING STATIONS PERTINENT TO ADDICKS AND BARKER
RESERVOIRS

USGS Station Name	USGS Station Number	Latitude and Longitude (1) (Decimal Degrees)	Monitored Parameter	Monitored Parameter Units
Cypress Ck at Sharp Rd nr Hockley, TX	08068700	N 29.921058 W 95.840229	Precipitation Gage height	in ft
Cypress Ck at Katy-Hockley Rd nr Hockley, TX	08068720	N 29.95022 W 95.80828	Discharge Gage height	ft ³ /s ft
Cypress Ck at House-Hahl Rd nr Cypress, TX	08068740	N 29.959112 W 95.717725	Discharge Gage height	ft ³ /s ft
Buffalo Bayou nr Katy, TX	08072300	N 29.743287 W 95.806895	Precipitation Discharge Gate height	in ft ³ /s ft
Buffalo Bayou nr Fulshear, TX	08072350	N 29.723009 W 95.767172	Precipitation Gage height	in ft
Barker Res nr Addicks, TX	08072500	N 29.769951 W 95.647168	Precipitation Reservoir storage Water surface elevation	ln ac-ft ft
Buffalo Bayou at State Hwy 6 nr Addicks, TX	08072600	N 29.769381 W 95.643167	Discharge Gage height	ft ³ /s ft
S Mayde Ck nr Addicks, TX	08072700	N 29.801062 W 95.692447	Gage height	ft
Bear Ck nr Barker, TX	08072730	N 29.830783 W 95.686891	Discharge Gage height	ft ³ /s ft
Langham Ck at W Little York Rd nr Addicks, TX	08072760	N 29.86717 W 95.646612	Precipitation Discharge Gage height	ln ft ³ /s ft
Langham Ck nr Addicks, TX	08072800	N 29.835782 W 95.625778	Gage height	ft
Addicks Res nr Addicks, TX	08073000	N 29.791339 W 95.623556	Reservoir storage Water surface elevation	ac-ft ft
Buffalo Bayou nr Addicks, TX	08073500	N 29.761896 W 95.605778	Discharge Gage height	ft ³ /s ft
Buffalo Bayou at W Belt Dr, Houston, TX	08073600	N 29.762173 W 95.557721	Precipitation Discharge Gage height	ln ft ³ /s ft
Buffalo Bayou at Piney Point, TX	08073700	N 29.746896 W 95.523554	Discharge Gage height	ft ³ /s ft
Buffalo Bayou at Houston, TX	08074000	N 29.760228 W 95.408551	Discharge Gage height	ft ³ /s ft

(1) Latitude and Longitude values are in North American Datum of 1983 (NAD 83).

b. Reporting.

1. The reporting procedures for gaging stations are on a cooperative basis with the USGS. All gaging stations are automated gages consisting of pressure sensors, bubble gages or radar sensors supplying data to data collection platforms. Some automated

gaging stations are equipped with automated rain gages that provide precipitation data. These gaging stations automatically report pool elevations, stream gage heights and precipitation using the data collection platform (DCP), which records the data and transmits it hourly or when a threshold value is exceeded. The reporting of data from pool elevation and stream gaging stations has been automated by using DCPs that record data every fifteen minutes and transmit the data every hour or when a threshold value is exceeded. The data are transmitted via Geostationary Operational Environmental Satellite (GOES) to a Direct Receive Ground Station and computer facility, owned and operated by the National Oceanic and Atmospheric Administration (NOAA) at Wallops Island, Virginia. The data are rebroadcast over the Domestic Satellite System (DOMSAT) to the Fort Worth District's Direct Receive Only Terminal (DROT). Galveston District currently receives data through a network socket connection to a data acquisition server located in the Fort Worth District via the USACE network.

2. Rainfall and stream stage data are automatically stored in the CWMS database and used by the Water Management Section/H&H Branch in routine and emergency water management activities. Once in the database, the data are then utilized for checking project status, defining basin conditions, forecasting stream flows, and disseminating information to other USACE elements. Data from these files serve as the primary data source from which all water control functions are carried out. The processing of this data is by the CWMS programs developed by the USACE Hydrologic Engineering Center (HEC) at Davis, California.
3. Weather Radar and Gridded Rainfall. The NWS maintains twelve Doppler radar sites distributed across Texas, with an additional five sites located in adjacent states near the Texas state line. In addition, the NWS cooperates with the Department of Defense to obtain radar information from four military sites in Texas. The NWS provides multisensory precipitation estimates (MPE) to the Fort Worth District Water Resources Branch in a gridded XMRG format. The rainfall and river stage data are automatically processed and stored in data files within the CWMS database and used in routine and emergency water management activities.

c. Maintenance.

1. The NWS rainfall reporting sites are maintained by NWS personnel as a part of the observer network program. USACE provides

funding by interagency transfer to the NWS through the NWS/CORPS Cooperative Reporting Network Program operated on a nationwide basis.

2. Malfunctions of automated DCP rainfall, elevation, and stream-gage stations are reported to the USGS, which operates and maintains the gages. USACE provides funding by interagency transfer to the USGS through the USGS/CORPS Cooperative Stream Gaging Program operated on a nationwide basis.

5-02. Water Quality Stations. Since Addicks and Barker Reservoirs are detention-type reservoirs with only flood pools of short duration, water quality is not a consideration in their respective operations. Therefore, there are no water quality stations associated with the two reservoir projects.

- a. Facilities. There are no water quality stations associated with the two projects that are maintained by USACE.
- b. Reporting. The reporting procedures for water quality stations are made in cooperation with the USGS and EPA. The information is stored in the National Water Quality Portal at <https://www.waterqualitydata.us/>.
- c. Maintenance. Not applicable.

5-03. Sediment Stations. Sediment ranges have been established where major tributaries enter Addicks and Barker Reservoirs. The ranges, along tributaries, are re-surveyed at variable time intervals depending on the frequency of storm events, sedimentation rates, and available funding. To analyze the accumulated sedimentation within the dams, elevation capacity curves are compared. There has been four years of calculated capacity (1962, 1977, 2008, and 2018). The last two (2008 and 2018) were calculated using a Digital Elevation Model (DEM) derived from LiDAR.

- a. Facilities. Not applicable.
- b. Reporting. As necessary.
- c. Maintenance. Through outgrant agreements, the local entities maintain the inflow channels by removing excessive sediment.

5-04. Recording Hydrologic Data.

- a. Project Data
 1. Hourly values of stream stage, pool elevations, and precipitation are automatically transmitted to the USACE Water Management

System (CWMS) server via DCP. Upon receipt of the data, the values are decoded into engineering units and written to HEC-DSS and CWMS databases. Data is checked and corrected by regulation personnel, as necessary, for quality control.

2. Processed daily parameters (inflow and total release) are also archived in the project HEC-DSS file. Monthly totals are accumulated from the daily information and stored permanently in the project file. For permanent hard copy records required by ER 1110-2-240, daily and monthly data in the project file are used to publish monthly charts for Addicks and Barker Reservoirs.
 3. The rainfall and river stage data from the above sources are automatically diverted to data files within the WCDS and used by the Water Management Section/H&H Branch in routine and emergency water management activities. Once in these files, the data is utilized for checking project status, defining basin conditions, forecasting flows into the reservoirs, and disseminating information to other USACE elements. Data from these files serve as the primary data source from which all Hydrology and Hydraulics functions are carried out. The processing of this data is by internal computer software programs based on a database (DSS) developed by the USACE HEC located at Davis, California.
- b. Stream Gage Data. Stage data for Buffalo Bayou and other stations identified in Table 5-01 are received and processed into the project HEC-DSS file as described above. In addition to the Hydrology and Hydraulics computer files, the USGS maintains an archive of this station data.
 - c. Precipitation Data. The project HEC-DSS file stores precipitation data from the DCP stations after the data is checked and corrected by regulation personnel for quality control. Precipitation data received through the NWS-AWIPS system is also stored in the project HEC-DSS file. The NWS also records the data from their observer network permanently within their standard climatological records.

5-05. Communications Network. Primary communication is by phone and email. The Voice over IP (VoIP) phone system is maintained by the U.S. Army Corps of Engineers – Information Technology (ACE-IT). Backup radio communication is by a VHF-FM fixed station capable of reaching local mobile stations and other portable stations. If needed, the HF-SSB Radio system will be used to maintain contact with the Galveston District in an urgent or emergency situation. Further detail on the communications network is provided in the Emergency Action Plan.

5-06. Communication with the Project Office. While there is no scheduled or set daily communications between the Water Management Section/H&H Branch and the

projects, communications do occur on an as needed basis. Generally, communications between Water Management Section/H&H Branch and the project office are dependent on significant weather events and flooding activities within the watersheds. Other scenarios involving communications could involve dam safety issues, chemical spills, accidents, etc. Maintaining project releases within the criteria of Chapter VII does not require detailed real-time coordination. The primary mode of communication is by telephone, cell phone (to include voice and text messaging), and the HF-SSB Radio System as an alternative back-up system in an urgent or emergency situation.

- a. Communication between Regulating Office and Project Office. The Chief, Engineering and Construction Division, who is also designated as the Dam Safety Officer (DSO), through the Chief, Water Management Section/H&H Branch, is responsible for setting project regulating criteria for standard operations as documented in this manual and by separate communications for non-routine operations. Communication is normally by telephone or cell phone in response to any problems at either dam. Other communications between Water Management Section/H&H Branch and the project office will be for furnishing flow forecasts, alerting dam projects of developing floods, obtaining data, and scheduling special water releases. Should communications with the Water Management Section/H&H Branch be disrupted, the Damtender will direct regulation of the pool in accordance with the provisions of Chapter VII and Exhibit C (Standing Instructions to Damtender) of this manual and in accordance with the Emergency Action Plan.
- b. Communication between Regulating/Project Office and Others. Notifications should be made in accordance with the notification flowchart (Plate 9-01) and procedures in the Emergency Action Plan, dated 22 May 2014, and any subsequent annual updates.

5-07. Project Reporting Instructions. No hydrologic data are routinely reported by the project. However, in the event of a failure in the automated data system, the project personnel will furnish pool elevation, stream gage, and rainfall data to the Water Management Section/H&H Branch by telephone, cell phone, or district radio, if necessary. The actual reporting requirements will be established by the Chief of the Water Management Section/H&H Branch on a case by case basis to assure adequate data is available for the conditions that exist at the time. Non-routine items, such as malfunctioning gates, facilities problems, etc., that may affect normal project operations related to pool limits and release rates should be reported by telephone, to the Chief Water Management Section/H&H Branch. If these are expected to be long term impacts, the telephone report should be followed up by a memorandum from the Damtender to the Chief, Engineering and Construction Division who is also designated as the DSO.

5-08. Warnings. Flood emergency warnings and other information that needs to be passed to the general public will be coordinated and made in accordance with the Emergency Action Plan. Any announcements or warnings that involve public safety from flood releases and/or dam safety concerns are coordinated by the Galveston District with the Addicks and Barker Emergency Coordination Team (ABECT). In general, the Water Management Section/H&H Branch will provide these alerts to the ABECT and the Galveston District Public Affairs Office. For events which are developing locally, and often quite rapidly, Project Office personnel must provide the alert.

- a. Local Warnings. In rapidly changing situations where time frames are inadequate for dissemination of information through the above procedure, the Project Office will provide warnings or alerts to the local agencies responsible for the immediate areas of potential impact. The Offices of Emergency Management would be notified first followed by other critical local agencies, law enforcement, and the civil defense. The Project Office should maintain a current list of these agencies that would be endangered or adversely impacted by pool levels outside normal limits or by sudden or large changes in releases. Notifications to the agencies on this list would be by the most appropriate means in response to the situation that is developing. This could include telephone, cell phone, and radio.
- b. Flood Emergency Plan. Studies have been made to determine the possible downstream flood conditions that could exist for the Spillway Design Flood event. Reference the Emergency Action Plan, dated 22 May 2014, and any subsequent annual updates for further detail.

Five constant flow maps shown in Plates 5-02 through 5-08 have been included to show typical areas of inundation for certain prescribed flows in Buffalo Bayou: 3,000 cfs, 6,000 cfs, 10,000 cfs, 15,000 cfs, and 20,000 cfs. These maps indicate areas that may be inundated when the flow in Buffalo Bayou is known for the approximate area in question. A steady flow simulation was run using the HEC-RAS models, and the output was mapped with the HEC-GeoRAS extension for ArcGIS. It should be noted that these maps are the result of modeling assumptions that are not perfectly reflective of existing conditions. Due to times of travel and storage within the bayou reaches, it is unlikely that a flow in one section of the bayou will be identical to the flow in a different section of the bayou even if in close proximity. For example, when the flow at Piney Point (as shown by the USGS gauge) indicates a flow of 3,000 cfs, the flow at West Beltway 8 could be 2000 cfs or even 4000 cfs. The maps are included in the Emergency Action Plan so that local agencies have a quick reference to give an approximate area of inundation at various flow rates. They can then use these guides to know who to evacuate or what roads may be impassable.

5-09. Routine Information for Public Release. Information on current pool elevations, project releases, and stream stages collected as part of the Cooperative Streamgaging program are made available to the public on the USGS website. Information on forecasted pool elevations and releases are available on the Galveston District website or by request from the Water Management Section/H&H Branch. Additionally, information on the Addicks and Barker Reservoir releases are provided to the NWS-WGRFC to combine this information with rainfall estimates to generate river level forecasts along Buffalo Bayou downstream of the dams. These forecasts are available on the NWS Advanced Hydrologic Prediction Service (AHPS) website. See Paragraph 6-02.b.2 for the website link to NWS-AHPS.

VI - HYDROLOGIC FORECAST

6-01. General.

- a. Role of the Corps. The role of USACE is to make hydrologic forecasts for flood risk management. The forecasts are provided to project personnel, and planned changes in the release rates are furnished to the NWS-West Gulf River Forecast Center (NWS-WGRFC) in Fort Worth, Texas. The Public Affairs Office, which is kept informed of the lake conditions, makes news releases.
- b. Role of Other Agencies. NWS-WGRFC provides information about river flow and flood forecasts to USACE and to the general public. Timely access to weather and water information is provided through NWS systems, including the
 - NWS Home Page – www.weather.gov
 - NOAAPORT
 - NOAA Weather Wire Service (NWWS)
 - Emergency Managers Weather Information Network (EMWIN)
 - NOAA Weather Radio (NWR)
 - Family of Services (FOS)
 - Commercial weather information vendors

The NWS - Weather Forecast Offices (NWS-WFO) issues routine scheduled reports containing the following information:

1. Weather forecasts (daily forecasts, severe weather forecasts, and seven- day extended forecasts).
2. Quantitative Precipitation Forecasts (QPF): Twelve successive 6-hour precipitation forecasts are updated each 12 hours. Three successive 24-hour precipitation forecasts are updated every 12 hours. QPF is also created/issued by the NWS-WGRFC for ingest into the hydrologic models used for river stage forecasting. NWS-WGRFC QPF is available for viewing on the WGRFC webpage at www.weather.gov/wgrfc. NWS-WGRFC QPF is also transmitted to USACE via the Fort Worth District.
3. Five-day river stage forecasts, when conditions warrant, from the NWS-WGRFC.

4. Urgent priority messages, such as severe weather warnings, severe weather watches and statements, and instructions from civil defense centers during emergency situations.
5. Other information reports, on a periodic basis:
 - i. Winter weather and road conditions.
 - ii. River and flood warnings.
 - iii. Damage Reports.
 - iv. Thirty-day weather forecasts.

6-02. Flood Condition Forecasts.

- a. Requirements. Flood forecasts are required whenever substantial rainfall has fallen upstream or downstream of Addicks and Barker Reservoirs, considered to be greater than 2 inches, or when flood pools exceed the thresholds for Stage 1 Extended Watch, as defined in the Emergency Action Plan.
- b. Methods. USACE makes the following forecasts with assistance from the NWS:

1. Predicting Reservoir Pool Elevations. The HEC in Davis, California developed a real time water control software system. The Corps Water Management System (CWMS) is an integrated system of hardware and software used to derive the hydrologic response of the watersheds above and below the reservoirs. CWMS consists of PRECIP, HEC-HMS, HEC-ResSim, and HEC-RAS models. The models use a one-hour time interval.

Precipitation estimates are available from three main sources: precipitation gages, radar, and satellite. Weather Surveillance Radar-1988 Doppler (WSR-88D), also known as Next Generation Weather Radar (NEXRAD), observe the presence and calculate the speed and direction of severe weather. WSR-88D also provides estimated quantitative precipitation amounts. The NWS increases the accuracy of the WSR-88D quantitative precipitation estimates by a three-stage process. Stage I performs basic quality control of the radar data and converts reflectivity from the individual radar sites to precipitation rates. Stage II refines the quality of the radar data and precipitation estimates. The radar estimates are compared and if different, adjusted to measured rainfall from a variety of rain gauge networks, whose data is ingested at the NWS. Stage III formulates a composite rainfall pattern of bias-corrected estimates made by multiple radar sites. The hourly precipitation data is also obtained from rain gages equipped with DCPs and

maintained by either the USGS or Harris County Flood Control District.

The HEC-HMS model predicts runoff from the watersheds and derives reservoir inflows and local uncontrolled downstream flows from the hourly precipitation data. ResSim uses the projected reservoir inflows to forecast pool elevations and provide proposed releases to meet reservoir and downstream operation goals.

2. Predicting flood levels on Buffalo Bayou. The NWS-WGRFC ingests release information from Addicks and Barker from the USACE Galveston District and combines this information with rainfall estimates and forecasts to generate a forecast of river levels along Buffalo Bayou downstream of the Addicks and Barker Reservoirs. Forecasts are produced at three locations; West Belt, Piney Point, and Shepherd Drive. Forecasts from the WGRFC are sent to the NWS-WFO Houston/Galveston for dissemination to the public.

Forecasts are available on the NWS Advanced Hydrologic Prediction Service at
<http://water.weather.gov/ahps2/index.php?wfo=hgx>

6-03. Conservation Purpose Forecasts. Addicks and Barker are flood risk management reservoirs. They do not impound water except for flood risk management and are normally dry. These reservoirs do not have a water supply conservation mission.

- a. Requirements. Not Applicable.
- b. Methods. Not Applicable.

6-04. Long Range Forecasts. Addicks and Barker are flood risk management reservoirs. They do not impound water except for flood risk management and are normally dry. Long-range weather forecasts, however, are made by the NWS Climate Prediction Center and available online at <http://www.cpc.ncep.noaa.gov/>.

- a. Requirements. Not Applicable.
- b. Methods. Not Applicable.

6-05. Drought Forecast. Addicks and Barker are flood risk management reservoirs. They do not impound water except for flood risk management and are normally dry. These reservoirs do not have a drought contingency plan.

- a. Requirements. Not Applicable.

b. Methods. Not Applicable.

6-06. Water Quality Forecasting. Addicks and Barker are flood risk management reservoirs. They do not impound water except for flood risk management and are normally dry. These reservoirs do not have any water quality mission.

a. Requirements. Not Applicable.

b. Methods. Not Applicable.

VII - WATER CONTROL PLAN

7-01. General Objectives. Construction of Addicks and Barker Reservoirs (a portion of the Buffalo Bayou, Texas project) was authorized by the River and Harbor Act, approved 20 June 1938, and modified by the Flood Control Acts of 11 August 1939, and 3 September 1954, for flood control on Buffalo Bayou for the protection of the City of Houston, Texas.

The Flood Control Act of 1944 provided the authority to lease land in Addicks and Barker Reservoirs. Harris County leased 7,468 acres and developed Bear Creek Park for recreational purposes within the Addicks Reservoir area.

Public Law (PL) 89-72, Federal Water Project Recreation Act, provides for Federal cost sharing in recreation development at completed projects. The City of Houston is planning development of the proposed 10,600 acre Cullen Park, within the Addicks Reservoir area, under this Act.

PL 92-500, Federal Water Pollution Control Act, as amended by the Clean Water Act of 1977, requires that all Federal facilities shall be managed, operated, and maintained so as to protect and enhance the quality of water and land resources through conformance with applicable Federal, state, interstate and local substantive standards.

Reference the 2009 Master Plan, Addicks and Barker Reservoirs, Buffalo Bayou and Tributaries, Fort Bend and Harris Counties, Texas for additional land usage inside the reservoirs.

7-02. Constraints. Constraints on the operation of Addicks and Barker Reservoirs are many and varied.

- a. Spillway Design Flood Impacts. If pool levels are extremely high, there are concerns associated with flows flanking the ends of both dams or passing over the emergency spillways. Spillway Design Flood Impacts are currently being reanalyzed as part of the Dam Safety Modification Study and the ongoing Buffalo Bayou and Tributaries Resiliency Study, and this manual will be updated with results from the study after it is reviewed and approved.
- b. Upstream Reservoir Impacts. Acquisition of real estate was based on the 1940s-era design. Presently, pool levels in excess of Government-owned land will damage residential developments adjacent to Government-owned lands at both reservoirs

- c. Reservoir Release Restrictions. The original design included a downstream rectified channel and diversion channel with a capacity of approximately 18,000 cfs. In 1972, releases from the reservoirs, when combined with uncontrolled runoff and outflow from Addicks and Barker Reservoirs, were limited to 2,000 cfs due to embankment problems and continued development. Over the last ten years, surveys and observations along the bayou have determined that the present non-damaging channel capacity is approximately 4,000 cfs. Reservoir gates should only be opened uniformly (symmetrically) to maintain structural integrity of the outfalls.
- d. Pool Drawdown Rate. The pool drawdown rate is limited to one foot per day to prevent, if possible, dam embankment damage.

7-03. Overall Plan for Water Control Management. Addicks and Barker Reservoirs will be operated to provide maximum downstream flood protection on South Mayde Creek and Buffalo Bayou. Normal system operation will attempt to maintain equal available storage capacity for each reservoir within the constraints relating to the safety of the structure.

7-04. Standing Instructions to Project Operator (Damtender). A summary of these instructions is also included in Exhibit C.

- a. Normal Operation. The Natural Resource Management Specialist will act as Damtender when regulation is required. The duties of the Damtender are as follows:
 - 1. The Damtender will execute all instructions issued by the Water Management Section/H&H Branch relating to reservoir operations.
 - 2. The Damtender is to observe and be cognizant of all available hydrologic and meteorological data that is pertinent to the operation of the projects. This data, when requested by the Water Management Section/H&H Branch, will be reported by telephone, e-mail, or radio.
 - 3. The Damtender will dispatch personnel to the dam sites to keep the gates under surveillance whenever reservoir pool stages warrants in accordance with the Emergency Action Plan.
 - 4. If one inch of rainfall or more falls in 24 hours or less and is recorded at the dam or on the watershed downstream of the dam or if flooding is predicted downstream of the dams, the Damtender will contact the Water Management Section/H&H Branch for instructions. If an unwarranted delay does ensue, the Damtender

will proceed to the reservoirs, close the gates, and then contact Water Management Section/H&H Branch personnel.

5. When releases are being made, the Damtender will monitor downstream conditions. If flow approaches the limiting flow of 2,000 cfs at the Piney Point gage, or if one-half inch of rainfall in 24 hours or less occurs downstream or if flooding is predicted downstream of the dams, the Damtender will notify the Water Management Section/H&H Branch. If an unwarranted delay does ensue, the Damtender will proceed to both reservoirs, close the gates, and then contact Water Management Section/H&H Branch personnel.
 6. The conduit outlet and stilling basin must be visually monitored very closely during all releases and during all high tailwater events. If unusual conditions occur (such as riprap displacement, surging, or submerged outlet) notify the Water Management Section/H&H Branch and the Dam Safety Program Manager immediately.
 7. The Damtender will notify lessees of land in the reservoirs when advised by the Reservoir Control that flooding of their land is imminent to permit the removal of stock and equipment from pertinent areas.
- b. Emergency Operations. Communication between the Damtender and the Water Management Section/H&H Branch will be by telephone (primary), cell phone, or by e-mail, with the District radio net serving as a backup system in accordance with the Emergency Action Plan. Emergency operations are to be used if communications fail, the Damtender's instructions are as follows:
1. The Damtender will attempt to restore communications as soon as possible.
 2. If 1 inch of rainfall or more occurs in 24 hours or less downstream of the reservoirs and/or flooding is predicted or occurring downstream, the Damtender will close all gates on both reservoirs and keep them under surveillance until communications are restored, or an authorized representative of the District arrives, or the induced surcharge regulation schedule dictates releases.
 3. If flood control releases are in progress, flooding is not forecasted and rainfall downstream of the reservoirs is less than one-half inch in 24 hours, then no change in operation will be made until communications are restored or the induced surcharge regulation schedule dictates releases.

4. If flood control releases are in progress and rainfall downstream of the reservoirs is more than one-half inch in 24 hours or less, or flooding is predicted, the Damtender will close all gates on both reservoirs unless the induced surcharge regulation schedules (see paragraph 7-05.b.) are controlling.
5. If inflow and pool elevation conditions dictate the use of the induced surcharge regulation schedule and instructions from the Water Management Section/H&H Branch are unavailable, releases will be made by the Damtender in accordance with the induced surcharge regulation schedules shown on Plates 7-03 and 7-04. The gates should remain at the maximum opening attained from the induced surcharge regulation schedules until reservoir levels fall to elevation 101 feet NAVD88 in Addicks Reservoir and 94.9 feet NAVD88 in Barker Reservoir. Then, if the outflow from both reservoirs, when combined with the uncontrolled runoff downstream is greater than channel capacity, adjust the gates until the total discharges do not exceed channel capacity and follow the normal operating procedures.
6. The conduit outlet and stilling basin must be visually monitored very closely during all releases and during all high tailwater events. If unusual conditions occur (such as riprap displacement, surging, or submerged outlet) close all conduit gates immediately and continue efforts to re-establish communications with the district office and dam safety personnel.

7-05. Flood Risk Management. In keeping with the primary objective of flood control for Addicks and Barker Reservoirs, the general plan for reservoir regulation will be to operate the reservoirs in a manner that will utilize, to the maximum extent possible, the available storage to prevent the occurrence of damaging stages on Buffalo Bayou within the limits placed by the constraints on project operations.

- a. Normal Flood Control Regulation. Water Management Section/H&H Branch has the responsibility for directing the regulation of Addicks and Barker Reservoirs. Normal conditions are defined to exist when the reservoir pools are not in the range of the induced surcharge schedule.
 1. If flooding on Buffalo Bayou is neither expected nor occurring, the reservoirs will operate with two conduit gates at each outlet works set at an opening of 1.0 foot each, allowing for the passage of normal low flows.

2. The gates on both reservoirs will be closed when 1 inch of rainfall occurs over the watershed downstream of the reservoirs in 24 hours or less, or when flooding is predicted downstream.
 3. Keep the gates closed and under surveillance as long as necessary to prevent flooding downstream of the dams. Begin releases in accordance with the paragraph below or in accordance with the induced surcharge schedule if pool elevations exceed 101 feet NAVD88 in Addicks Reservoir or 95.7 feet NAVD88 in Barker Reservoir. Continue these operations until the flood control storage has been evacuated or, in the case of induced surcharge releases, until a peak pool elevation is attained. Initial releases shall be made through two conduit gates until additional discharge capacity is needed.
 4. If inflow and pool elevation conditions do not dictate use of the induced surcharge regulation schedule for the reservoirs and the downstream runoff has receded to non-damaging stages, then open gates gradually to release amounts which, when combined with uncontrolled runoff, will not exceed 2,000 cfs at Piney Point. In order to maintain equal available storage in both reservoirs, releases based on available downstream channel capacity will be made at rates necessary to maintain a difference in reservoir storages of no more than 20 percent. If, during the release period, rains in excess of 0.5 inch within 24 hours fall over the watershed downstream of the reservoirs or flooding is predicted, the gates will be closed until the above operations can be resumed.
 5. When the reservoirs are emptied, close gates to normal position of two conduit gates at each outlet works at an opening of 1.0 foot each, allowing for the passage of normal low flows.
- b. Induced Surcharge Flood Control Regulation. At any time the reservoir pool equals or exceeds 101 feet NAVD88 in Addicks Reservoir and 95.7 feet NAVD88 in Barker Reservoir, monitoring of both pool elevations should immediately begin to determine if inflows are causing the pool elevations to continue to rise. If inflow and pool elevation conditions dictate, both reservoir releases will be made in accordance with the induced surcharge regulation schedules shown on Plates 7-03 and 7-04. Using the horizontal curve that corresponds to the appropriate rate-of-rise, locate the pool elevation that the reservoir is currently at, on the vertical axis. The corresponding surcharge release rate is read from the horizontal axis. The bold vertical lines provide recommended gate openings to achieve the requisite surcharge release rates. The gates should remain at the maximum opening attained from the induced surcharge regulation schedules until reservoir levels fall to elevation 101 feet NAVD88 in

Addicks and 94.9 NAVD88 feet in Barker. Then, if the outflow from both reservoirs, when combined with the uncontrolled runoff downstream, is greater than channel capacity, adjust the gates until the total discharges do not exceed channel capacity and follow the normal operating procedures.

The conduit and stilling basin must be visually monitored very closely during all high releases and during high tailwater events. If unusual conditions occur (such as riprap displacement, surging, or submerged outlet) notify the Water Management Section/H&H Branch and Dam Safety immediately.

- c. Constraints Regarding Flood Control Operation. Constraints on flood control operation are the same constraints enumerated in paragraph 7-02.

7-06. Recreation. Addicks and Barker Reservoirs are detention reservoirs with a normally dry pool. The normal dry state of the reservoir area has encouraged local interest in recreational development on the Government-owned land.

- a. Land Usage. Harris County has leased 3,085 acres in Addicks Reservoir for Bear Creek Pioneer Park. This land use development includes camping areas, hiking trails, picnic areas, playground areas, petting zoo, baseball fields, soccer fields, dog park, Precinct 3 Headquarters, County Extension Agent. A Farm and Ranch Club, a Community Center, and sports fields and courts. Use of the pool above elevation 88.9 feet NAVD88 for flood control starts to restrict the use of these facilities and creates public relation problems. Harris County has leased 7,800 acres in Barker Reservoir for George Bush Park. This development includes hike and bike trails, picnic areas, playground areas, baseball fields, soccer fields, model airplane airport, dog park and a shooting range. Use of the pool above elevation 89.2 feet NAVD88 for flood control starts to restrict the use of these facilities and creates public relation issues.

The City of Houston, Texas, has leased 9,270 acres in Addicks Reservoir for Cullen Park. This development includes a veladrome and community park. This development will produce similar issues when water levels reach certain elevations. The city has no leased acreage in Barker Reservoir.

Fort Bend County has leased 1,961 acres in Barker Reservoir. This development includes a day camp for the scouts. This development will produce similar issues when water levels reach certain elevations.

- b. Reservoir Regulation for Special Events. In the late 1980's, a request was made of the Galveston District to provide water for a special event on

Buffalo Bayou. The district commander honored this request as a way to support the community. Every year since then, the district has stored water for certain events by a deviation from the approved Water Control Plan. These events have historically been the Buffalo Bayou Regatta sponsored by the Buffalo Bayou Partnership, Buffalo Bayou Trash Bash, and a charity event involving a Houston Rubber Duck Race.

A request for a deviation from the Regulation Manual for Addicks and Barker Reservoirs was granted in April of 1989. The letter of approval, signed by the Chief of Engineering, Southwestern Division gave approval to store water in both reservoirs every year for these special events with the understanding that the impoundment of only this amount of water would ensure minimum impact on these projects. It was recommended that a revision be made to the Water Control Manual to address these special requests.

Based on the above authorization, water can be stored to an elevation of 78.9 feet NAVD88 in Addicks Reservoir and 79.7 feet NAVD88 in Barker Reservoir to support special events without deviation approval. Even though a deviation will not be necessary from Southwestern Division to store water up to an elevation of 78.9 feet NAVD88 in Addicks or 79.7 feet NAVD88 in Barker for these events, the Water Management Section/H&H Branch will notify Reservoir Control personnel in Southwestern Division of the events prior to initiation. This will serve to keep Southwestern Division personnel aware of district involvement with such events and be able to respond to any issues that might arise from district participation. Reservoir regulation for these events will not be allowed to impact the overall mission of the projects.

7-07. Water Quality. Addicks Reservoir does not have an ongoing water quality program at the present time.

7-08. Fish and Wildlife. None.

7-09. Water Conservation/Water Supply. None.

7-10. Hydroelectric Power. None.

7-11. Navigation. Addicks and Barker Reservoirs are not navigation projects; however, the sedimentation trap from both reservoirs reduces the sediment inflow into the Houston Ship Channel.

7-12. Drought Contingency Plans. Addicks and Barker Reservoirs are kept dry for flood risk management. Therefore, a Drought Contingency Plan is not applicable to these two reservoirs.

7-13. Flood Emergency Action Plans. Reference “Emergency Action Plan, Addicks Reservoir and Barker Reservoir, Annex I to Galveston District Emergency Operation Plan,” Completion Date: 22 May 2014, and any subsequent annual updates. This is a stand-alone document. Copies are located in the Emergency Management Office and the Engineering and Construction Division, who is also designated as the DSO.

The Emergency Action Plan outlines procedures for advanced preparation, extended watch for detection, and emergency response actions by the Galveston District. The procedures prescribed in the Emergency Action Plan become automatically effective when actual or predicted water surface elevations within the reservoirs reach designated limits or when the District Commander declares an emergency condition. The District Commander is responsible for declaring an emergency condition and initiating the internal USACE notification process. The extent to which the District Commander activates emergency elements will be dependent upon conditions at Addicks and Barker Reservoirs and flooding on Buffalo Bayou downstream of the reservoir.

7-14. Other. None

7-15. Deviation from Normal Regulations. The District Engineer is occasionally requested to deviate from the normal regulation of the reservoirs. Prior approval for a deviation is obtained from Southwestern Division except as noted in section 7-06 subparagraph b and subparagraph a below. Deviation requests usually fall under the following categories:

- a. Emergencies. Some emergencies that can be expected are: drowning and other accidents, failure of operation facilities, and flushing of pollution where water quality is not a project purpose. Necessary action under emergency conditions is taken immediately unless such action would create equal or worse conditions. Southwestern Division will be informed as soon as practicable. A written confirmation showing the deviation and conditions will be furnished to Reservoir Control personnel in Southwestern Division.
- b. Unplanned Minor Deviations. There are unplanned instances that create a temporary need for minor deviations from the normal regulation of the reservoirs, although they are not considered emergencies. Construction activities account for the major portion of the incidents can include utility stream crossing, bridge work, and major construction contracts. Changes in releases are sometimes necessary for maintenance and inspection. Requests for changes of release rates are generally for a few hours to a few days. Each request is analyzed on its own merits. Consideration is given to upstream watershed conditions, potential flood threat, condition of the reservoirs, and possible alternative measures. In the interest of maintaining good public relations, the requests are complied with, providing there are no adverse effects on the overall operation of the

projects for the authorized purposes. Approval for these minor deviations will normally be obtained from Reservoir Control personnel in Southwestern Division by telephone. A written confirmation showing the deviation and conditions will be furnished to Reservoir Control personnel in Southwestern Division.

- c. Planned Deviations. Each condition should be analyzed on its own merits. Sufficient data on flood potential, reservoir and watershed conditions, possible alternative measures, benefits to be expected, and probable effects on other authorized and useful purposes will be presented by e-mail to Reservoir Control personnel in Southwestern Division along with recommendations for review and approval.
- d. Unplanned Major Deviations. There are unplanned instances that create a temporary need for major deviations from the normal regulation plan and may be considered, but are not emergencies. Flood control releases account for the major portion of these incidents and typical examples include project pre-releases or exceeding downstream channel capacity, incidents that have a short window of opportunity in an effort to minimize damages or optimize benefits. Requests for changes in release rates generally involve time periods ranging from a few hours to a few days. Each request is analyzed on its own merits. In evaluating the proposed deviation, consideration must be given to upstream watershed conditions, potential flood threat, condition of the reservoirs, and alternative measures that can be taken. Approval for these major deviations normally will be obtained from the Southwestern Division by telephone or email. Written confirmation explaining the deviation and its cause will be furnished to the Southwestern Division water control manager.

7-16. Rate of Release Change. Changes in release rates will be accomplished in a manner which minimizes damage to the downstream channel. Every reasonable precaution will be made to prevent, if possible, bank sloughing, undercutting, excessive erosion, and danger to human and animal lives. Generally, limit the change in opening of the service gates to no more than one foot per each half hour for each gate, corresponds to approximately 300-400 cfs per change per dam. All gate operations should be symmetrical as practical with an allowable difference in gate openings not to exceed one foot.

7-17. Operation Curves and Tables. Area-Capacity curves for Addicks and Barker Reservoirs are shown on Plates 7-01 and Plate 7-02, respectively. Induced Surcharge Regulation Schedule curves for Addicks and Barker Reservoirs (assuming no tailwater effect on discharges) are shown on Plates 7-03 and 7-04, respectively. The outlet rating curves for Addicks and Barker Reservoirs are shown on Plates 7-05 and 7-06, respectively.

Elevation-Area/Capacity tables are included in this manual as Table 7-01 for Addicks Reservoir and in Table 7-02 for Barker Reservoir. These tables were based upon survey data gathered in 2002 and are located in this manual in the Supplementary Tables section.

VIII - EFFECT OF WATER CONTROL PLAN

8-01. General. The main purpose of both Addicks and Barker Reservoirs is flood risk management. The reservoirs also provide recreational benefits and limited habitat for wildlife.

8-02. Flood Risk Management.

- a. Spillway Design Flood. The original spillway design floods were computed in 1940. This design was performed before construction of the reservoirs. The spillway design storm for the study was the 1899 Hearne, Texas storm modified to include the rates of rainfall recorded at Taylor, Texas on the 9th and 10th of September 1921. The average rainfall over a 100 square mile area for this storm was about 30 inches in 72 hours, with a peak intensity of 4.40 inches per hour. For the original design of Addicks Reservoir, the peak inflow was estimated to be 50,000 cfs, and the total inflow volume was estimated to be 190,000 acre-feet. For Barker Reservoir, the peak inflow was estimated to be 40,300 cfs, and the total inflow volume was estimated to be 214,500 acre-feet.

There are considerable differences between the 1940 design features discussed above and the actual constructed project. Features included in the 1940 design that never were constructed included a levee to prevent Cypress Creek watershed flows from entering Addicks Reservoir, a Reservoir on White Oak Bayou, and a system of canals to convey releases from White Oak Bayou to the San Jacinto River. During construction, it was determined to be more economically feasible to increase the capacity of Addicks Reservoir to accommodate Cypress Creek overflows, and the levee was never constructed. A review of reports in 1952 concluded that rising land costs and rapid development made construction of White Oak Reservoir and the canals economically unfeasible.

In 1962, the "Reservoir Regulation Manual for Addicks and Barker Reservoirs" was released with revised spillway design flood information that accounted for the actual constructed project. This 1962 design included all gated conduits and included the Cypress Creek overflow into Addicks Reservoir, Brays Bayou rectification, Buffalo Bayou Rectification, and White Oak Bayou rectification. Previously prepared unit hydrographs were used to compute volumes of runoff as well as peak flows and times of peaks. Routing was performed using the coefficient method. For additional information, reference the 1962 Reservoir Regulation Manual for Addicks and Barker Reservoirs.

In 1977, a restudy of Addicks and Barker Reservoirs was deemed necessary because urbanization was reaching levels in excess of the original 1962 design study. Details of this restudy can be found in "Buffalo Bayou and Tributaries, Addicks and Barker Reservoirs, Hydrology," dated August 1977. Spillway design flood inflow hydrographs were computed consistent with Standard 1 design criteria as outlined in EC 1110-2-163, "Spillway and Freeboard Requirements for Dams," dated August 1975. In accordance with these criteria, the adopted spillway design storm was of probable maximum severity.

The 1977 spillway design rainfall was determined in accordance with the method described in Hydrometeorological Report No. 51, dated September 1976, entitled "Probable Maximum Precipitation Estimates, United States East of the 105h Meridian." The average rainfall for the spillway design flood was computed as 44.6 inches in 72 hours, with a peak intensity of 11.3 inches. The watershed of Addicks and Barker Reservoirs, Cypress Creek, and Buffalo Bayou upstream of Piney Point were modeled to reflect ultimate conditions using the generalized storm network computation capability of HEC-1. Basins and subbasins were delineated on topographic maps of the study area. Loss rates and unit hydrograph coefficients were based on gages in the Houston area. All stream flow routing was accomplished using the Modified Puls method. Unit hydrographs of storm runoff were computed for each basin using the Clark synthetic unit hydrograph procedure.

The 1977 flood hydrograph adopted for Addicks Reservoir was produced by the spillway design storm centered over Addicks Reservoir Watershed, and the flood hydrograph adopted for Barker Reservoir was produced by the spillway design storm centered over Barker Reservoir Watershed. These centerings were selected because they produce the largest inflow rates into the reservoirs. For Addicks Reservoir, the peak inflow was calculated as 294,570 cfs, and the total inflow volume was calculated as 462,145 acre-feet (approximately one-third of the inflow volume is overflow from Cypress Creek). For Barker Reservoir, the peak inflow was calculated as 255,779 cfs, and the total inflow volume was calculated as 279,072 acre-feet. For additional information on the calculation of the SDF, reference the 1977 hydrology report. The adopted spillway design flood hydrographs for Addicks and Barker are shown on Plates 8-01 and 8-02.

The spillway design flood is currently being reanalyzed, and this manual will be updated when the updated analysis is completed and approved.

- b. Standard Project Flood. The original Standard Project Floods (SPFs) were computed in 1940. As with the original Spillway Design Flood, the original SPF was calculated incorporating features that were never

actually constructed. In the original design of Addicks Reservoir, the peak inflow was estimated to be 41,000 cfs, and the total inflow volume was estimated to be 146,000 acre-feet. For Barker Reservoir, the peak inflow was estimated to be 32,300 cfs, and the total inflow volume was estimated to be 164,000 acre-feet.

In 1962, the "Reservoir Regulation Manual for Addicks and Barker Reservoirs" was released with revised SPF information, including the current design at that time. The 1962 design included all gated conduits and included the Cypress Creek overflow into Addicks Reservoir, Brays Bayou rectification, Buffalo Bayou rectification, and White Oak Bayou rectification.

Previously prepared unit hydrographs were used to compute volumes of runoff as well as peak flows and times of peaks. Routing was performed using the coefficient method. For additional information reference the 1962 Reservoir Regulation Manual.

In 1977, the SPF inflow hydrographs were computed for Addicks and Barker Reservoirs using the same methodology previously described in the spillway design flood section. Rainfall was taken as 50 percent of the spillway design rainfall. For Addicks Reservoir the SPF peak inflow has been computed as 124,094 cfs, and the total inflow volume was computed to be 193,956 acre-feet (approximately one-third of the inflow volume is overflow from Cypress Creek). For Barker Reservoir the peak inflow was computed to be 86,961 cfs, and the total inflow volume was computed to be 125,061 acre-feet. The adopted SPF hydrographs for Addicks and Barker are shown on Plates 8-03 and 8-04.

The SPF is currently being reanalyzed, and this manual will be updated when the updated analysis is completed and approved.

- c. Other Floods. Tables 8-01 and Table 8-02 include details for the top ten significant pools for Addicks and Barker Reservoirs.

TABLE 8-01
ADDICKS RESERVOIR – OTHER SIGNIFICANT FLOOD EVENTS

DATE	ELEV (1)	SURFACE AREA IN ACRES	CAPACITY IN ACRE-FEET (2)	% CAPACITY MAX. POOL (3)
30 AUG '17	109.10	16,989	217,896	100.0
23 APR '16	102.65	12,834	123,067	61.1
9 MAR '92	97.46	9,189	65,264	32.7
30 APR '09	96.90	8,771	60,233	30.2
7 NOV '02	96.45	8,395	56,371	28.2
17 NOV '98	95.70	7,809	50,301	25.2
23 OCT '94	95.63	7,759	49,757	24.9
31 MAY '15	95.51	7,673	48,831	24.5
15 MAY '68	95.16	7,425	46,189	23.1
25 NOV '04	94.88	7,242	44,137	22.1

TABLE 8-02
BARKER RESERVOIR – OTHER SIGNIFICANT FLOOD EVENTS

DATE	ELEV (1)	SURFACE AREA ACRES	CAPACITY IN ACRE-FEET (2)	% CAPACITY MAX. POOL (3)
30 AUG '17	101.56	15,149	170,941	81.6
25 APR '16	95.24	12,090	85,816	40.9
6 MAR '92	93.60	11,494	66,489	31.7
7 NOV '02	93.24	11,404	62,368	29.8
18 NOV '98	92.31	10,987	51,934	24.8
1 JUN '15	91.87	10,748	47,150	22.5
9 JUL '07	91.85	10,736	46,935	22.4
28 NOV '04	91.69	10,699	45,225	21.6
20 APR '91	91.34	10,425	41,539	19.8
1 MAY '09	91.21	10,347	40,189	19.2

NOTES:

- (1) Elevations of water surface are in feet-NAVD88.
- (2) One acre-foot of water is one acre of water, one foot deep.
- (3) Percent of capacity of maximum possible pool before water spills around the ends of the dams.

8-03. Recreation. Recreational areas are available to the public in both Addicks and Barker Reservoirs. Reference the 2009 Master Plan for Addicks and Barker Reservoirs provides further detail. The district has approved construction of a variety of recreational and multi-use facilities while protecting and preserving the natural habitat in the reservoirs. The recreation opportunities are numerous, which includes a variety of parks, hike and bike trails, nature studies, and photography.

There are three types of wildlife habitat, open land, woodland, and wetlands that harbor many types of animals including birds, deer, reptiles, and amphibians.

Reservoir pools inundate some of these areas from time to time, but the majority of the recreational facilities are in the upper reaches of the reservoirs and do not flood often. Except for periods of heavy rainfall, the dams do not normally impound water.

8-04. Water Quality. There are no water quality interests associated with Addicks and Barker Reservoirs.

8-05. Fish and Wildlife. There are no fish and wildlife interests associated with Addicks and Barker Reservoirs. The area does provide some limited habitat for game, such as deer, fish, and birds. This is not a purpose of the reservoirs but a positive side effect due to the existence of the reservoirs.

8-06. Water Conservation/Water Supply. There are no water supply interests associated with Addicks and Barker Reservoirs.

8-07. Hydroelectric Power. There are no hydroelectric interests associated with Addicks and Barker Reservoirs.

8-08. Navigation. There are no navigation interests associated with Addicks and Barker Reservoirs.

8-09. Drought Contingency Plans. There are no drought contingency plans associated with Addicks and Barker Reservoirs.

8-10. Flood Emergency Action Plan. Reference "Emergency Action Plan, Addicks Reservoir and Barker Reservoir, Annex I to Galveston District Emergency Operation Plan," Completion Date: 22 May 2014. This is a stand-alone document. Copies are located in Emergency Management and the Engineering and Construction Division.

The Emergency Action Plan, dated 22 May 2014, outlines procedures for advanced preparation, extended watch for detection, and emergency response actions by the Galveston District. The procedures prescribed in the Emergency Action Plan become automatically effective when actual or predicted water surface elevations within the reservoirs reach designated limits or when the District Commander declares an emergency condition. The Emergency Action Plan for Addicks and Barker Dams is directed at recognizing potential dam safety dangers, outlining actions to be taken, and assuring key individuals are aware of their respective responsibilities and have ready access to a plan of action outlining their roles.

The District Commander is responsible for declaring an emergency condition and initiating the internal USACE notification process. The extent to which the District Commander activates emergency elements will be dependent upon conditions at Addicks and Barker Reservoirs and flooding on Buffalo Bayou downstream of the reservoir.

8-11. Frequencies.

- a. Peak Inflow Probability. Pool probabilities up to the 0.1% were derived using Markov chain Monte Carlo simulation based on distributions of peak inflow and critical duration inflow volumes and their statistical relations to peak reservoir elevations. Analyses were performed following RMC-TR-2018-03. Peak inflow and peak inflow volume distributions were determined using USGS Bulletin 17C methods (authored by John F. England, USACE, and others, 2018). The following Table 8-03 tabulates peak inflows derived from USGS Bulletin 17C analyses.

TABLE 8-03
PEAK INFLOW FROM USGS BULLETIN 17C ANALYSIS

Percent Chance Exceedance	Flow (cfs)	Lower 90% Confidence Interval	Upper 90% Confidence Interval
<u>Addicks Reservoir</u>			
0.1	170,600	82,570	560,200
0.2	145,570	76,490	416,700
1	94,650	59,820	201,400
2	75,800	51,350	143,200
4	58,800	42,100	99,020
10	39,070	29,140	56,940
50	11,590	8,670	15,470
90	2,960	1,770	4,200
<u>Barker Reservoir</u>			
0.1	103,300	47,700	290,900
0.2	91,540	46,080	227,700
1	64,880	40,310	124,500
2	53,880	36,540	93,690
4	43,260	31,560	68,770
10	29,970	22,820	42,450
50	9,190	6,800	12,420
90	2,130	1,180	3,110

- b. Pool Elevation Duration and Frequency. Pool inflow-frequency curves are shown on Plate 8-05 for Addicks Reservoir and 8-06 for Barker Reservoir. The pool elevation-frequency curves are shown on Plate 8-07 for Addicks Reservoir and 8-08 for Barker Reservoir.
- c. Key Control Points. The key control point for the operations of the Addicks and Barker Reservoirs is the gage at Piney Point (USGS station number 8073700). A stage-discharge curve for the Piney Point gage is included

as Plate 4-02. The location of this key control point and other monitoring gages are displayed on Plate 5-01.

8-12. Other Studies.

- a. Examples of Regulation. In the first filling plan, procedures will be developed to verify the updated rating curves and update this manual, as necessary.
- b. Channel and Floodway Improvement. None.
- c. Miscellaneous Studies. The Bipartisan Budget Act of 2018 (PL 115-123) appropriated funds for "...emergency situations at Corps of Engineers projects, and to construct, and rehabilitate and repair damages caused by natural disasters, to Corps of Engineers projects..." Per the Policy Guidance on Implementation of Supplemental Appropriations in the Bipartisan Budget Act of 2018, dated 9 August 2018, paragraph 4 and Enclosure 4, USACE identified the Buffalo Bayou and Tributaries Resiliency Study as a study to be funded by the Supplemental Investigations fund. This study is being conducted under Section 216, Review of Completed Projects.

The Harris County Flood Control District and the Federal Emergency Management Agency (FEMA) are partnering on a flood hazard assessment project. The Harris County Flood Control District applied for and has received a grant from FEMA to provide funding for the first phase, which include Addicks and Barker Reservoirs, Buffalo Bayou, White Oak Bayou, and Cypress Creek.

IX - WATER CONTROL MANAGEMENT

9-01. Responsibilities and Organization.

a. USACE. Addicks and Barker Reservoirs are owned by the U.S. Government and operated by USACE. The Galveston District maintains full responsibility for its day-to-day operation and regulation. Operations and maintenance at the project are the responsibility of the Damtender operating under the functional authority of the Galveston District Project Operations Branch directly responsible to the Chief, Operations Division. Regulation procedures and criteria are the responsibility of the Chief, Water Management Section/H&H Branch operating under the functional authority of the Chief of Engineering and Construction Division, who is also designated as the DSO. The regulation procedures and criteria to be followed by the Damtender are presented in Chapter VII and are condensed in Exhibit C as Standing Instructions To Damtender. An Organization and Communications Chart for Water Management is shown on Plate 9-01.

1. The Chief, Water Management Section/H&H Branch is responsible for preparing and publishing a project Water Control Manual with the water management procedures and criteria for the project in compliance with ER1110-2-240. The manual serves as the standard water control plan for the project and is used at all times except when superseded by an approved deviation as provided for in Chapter VII or the approved Addicks and Barker Emergency Action Plan in response to Dam failure.
2. The Damtender is responsible for maintaining the project releases and pool levels specified in this Water Control Manual.
3. The Southwestern Division Reservoir Control Center is responsible for reviewing and determining the acceptability of the recommended standard water control plan and deviation requests, as needed.

b. Other Federal Agencies.

1. The NWS has the responsibility for providing rainfall forecasts needed in water management functions.
2. The USGS has the responsibility for providing stream flow data needed in water management functions.

- c. State, County, and Local Agencies. Harris County Flood Control District, as a part of their emergency operations, provides rainfall data used in water management functions.
- d. Private Organizations. These organizations have no responsibility in the operation of the projects.

9-02. Interagency Coordination.

- a. Local Press and USACE Bulletins. There are currently no standing contracts with local press or USACE Bulletins associated with Addicks and Barker Reservoirs.
- b. National Weather Service. USACE participates in a Cooperative Rainfall Network Program with the NWS for collecting rainfall data as described in paragraph 5-01.
- c. U.S. Geological Survey. As detailed in paragraph 5-01, the USGS operates and maintains USACE stream gages as a function of the CE/USGS cooperative stream gaging program to provide the stage data, stream flow and rainfall data needed in the USACE real time water management activities.
- d. Power Marketing Agency. There is no hydroelectric component associated with Addicks and Barker Reservoirs.
- e. Other Federal, State, or Local Agencies. Since 2007, the district and its local, state, and federal partners have participated in the ABECT. This team includes Galveston District, USGS, NWS-HGX, NWS-WGRFC, Harris County, Fort Bend County, City of Houston, Village Fire Department, Texas Department of Public Safety, and Texas Department of Transportation. The purpose of ABECT is to maintain effective interagency communications and prepare for coordinated responses to severe rain events affecting the Addicks and Barker Reservoirs.

9-03. Interagency Agreements. There are no interagency agreements associated with Addicks and Barker Reservoirs.

9-04. Commissions, River Authorities, Compacts, and Committees. There are no commissions, river authorities, compacts, or committees associated with Addicks and Barker Reservoirs.

9-05. Non-Federal Hydropower. There are no non-federal hydropower interests associated with Addicks and Barker Reservoirs.

9-06. Reports.

- a. Daily Reservoir Report. This report is prepared by the Water Management Section/H&H Branch daily to cover a period of 24 hours. The report provides data for use by personnel whose work requires knowledge pertaining to the regulation of reservoirs, field investigations, stream gaging, construction activities affected by releases from reservoirs, answering public inquiries, and preparing public releases.
- b. Monthly Reservoir Report. The Water Management Section/H&H Branch prepares the monthly reservoir reports in accordance with ER 1110-2-240. These reports are a tabular record of regulation for all flood control, navigation, or multiple-purpose storage reservoirs that are under supervision of, or of direct interest to, the District Office. Supplemental information on the regulation of the reservoirs, such as explanation of deviations from approved schedules, are added as a note on the report or as an attachment. These reports are promptly prepared each month and maintained in such form as to be readily available for transmittal to the Chief of Engineers, or others, upon request.
- c. Flood Damage Report. The Water Management Section/H&H Branch submits data to the Emergency Operation Center (EOC) to be included in daily situation reports during floods in accordance with ER 500-1-1. The report contains various types of information relative to the floods. Information specifically required for reservoirs are as follows: name of reservoir, reservoir stage, predicted maximum stage and anticipated date, rates of inflow and outflow in cfs, percent of flood control storage utilized to date, and any special information particularly pertinent to the flood situation.
- d. Post Flood Report. This report is prepared in accordance with ER 500-1-1 as soon as practical after a flood causing major damage. The report describes flood emergency operations by USACE and others. Included in summary form are: available hydrologic information, damage estimates, and other engineering data considered to be essential for flood control and flood plain studies or for the review of possible claims against the United States. The report is prepared by the District Office Planning Section. Information derived from field investigations by personnel of the H&H Branch along with information compiled by the Water Management Section/H&H Branch is also included. The report should be completed within approximately three months of the time of flooding, including a statement on the final cost of flood damages occurring.
- e. Annual Report. This report is prepared by the Water Management Section/H&H Branch in accordance with ER 1110-2-240. The report contains a summation of the general conditions of the river basins and the

individual projects in the District for the preceding fiscal year. The report also presents the activities and accomplishments of the Water Management Section/H&H Branch for the past year. The report is forwarded to the Southwestern Reservoir Control Center for inclusion in the Division's Annual Report.

- f. Summary of Reports. Table 9-01 is a summary of the reports required in the regulation of reservoirs in the Galveston District.

TABLE 9-01
TABULATION OF REPORTS

Name of Report	When Required	Regulation Requiring Report
Daily Reservoir Report	Daily	-
Monthly Reservoir Report	Monthly	ER 1110-2-240
Flood Situation Reports	During Floods	ER 500-1-1
Post Flood Reports	Following a Flood Causing Major Damage	ER 500-1-1
Annual Reports	Annually	ER 1110-2-240

SUPPLEMENTARY TABLES

TABLE 1-01
PERTINENT MANUALS AND REPORTS FOR
ADDICKS AND BARKER RESERVOIRS

Title	Date
Definite Project Report, Basis of Design, Buffalo Bayou, Texas	June 1940
Definite Project Report, Construction Drafting Section, Buffalo Bayou, Texas	June 1940
Definite Project Report, Buffalo Bayou, Texas	June 1940
Construction Contract Drawings, Barker Dam	November 1941
Revised Construction Contract Drawings, Barker Dam	November 1941
Preliminary Report on Operation of Reservoir, Barker Dam	July 1942
Analysis of Design, Addicks Dam	September 1945
Construction Contract Drawings, Addicks Dam	March 1946
Revised Construction Contract Drawings, Addicks Dam	March 1946
Analysis of Design for Installation of Additional Sluice Gates, Addicks and Barker Reservoirs	October 1947
Report on Feasibility of Gating the Uncontrolled Conduits at Barker and Addicks Dams	September 1960
Design Memorandum No. 1, Gating the Uncontrolled Conduits, Addicks and Barker Dams	August 1961
Initial and Emergency Instructions to Damtender, Addicks and Barker Dams	April 1962
Reservoir Regulation Manual for Addicks and Barker Reservoirs	April 1962
Design Memorandum No. 1, Rehabilitation of Addicks and Barker Dams - Buffalo Bayou, Texas	February 1963
Design Memorandum No. 2, Master Plan for Barker Dam and Reservoir and Addicks Dam and Reservoir, Buffalo Bayou, Texas	August 1963

Summary Report on Review of Design Features of Existing Dams Under Jurisdiction of Galveston District	March 1967
(Periodic) Inspection Report No. 1, Buffalo Bayou and Tributaries, Addicks Dam, Texas	June 1969
(Periodic) Inspection Report No. 1, Buffalo Bayou and Tributaries, Barker Dam, Texas	June 1969
(Periodic) Inspection Report No. 2, Buffalo Bayou and Tributaries, Addicks Dam, Texas	June 1974
(Periodic) Inspection Report No. 2, Buffalo Bayou and Tributaries, Barker Dam, Texas	July 1974
Letter Report for Emergency Seepage Control, Buffalo Bayou and Tributaries, Addicks Dam, Texas	May 1977
Construction Contract Drawings, Seepage Control, Addicks Dam, Texas	June 1977
GDR 500-1-5, Emergency Operation Plan, Addicks and Barker Reservoirs, Emergency Employment of Army Resources	June 1977
Hydrology, Buffalo Bayou and Tributaries, Texas, Addicks and Barker Reservoirs	August 1977
Periodic Inspection Report No. 3, Buffalo Bayou and Tributaries, Addicks Dam, Texas	October 1977
Periodic Inspection Report No. 3, Buffalo Bayou and Tributaries, Barker Dam, Texas	October 1977
Reconnaissance Report, Buffalo Bayou and Tributaries, Texas, Major Rehabilitation of Addicks and Barker Dams	October 1977
Design Memorandum No. 2, Updated Master Plan, Addicks and Barker Dams	November 1977
Letter Report for Spillways, Addicks and Barker Dams	January 1978
Construction Contract Drawings, Seepage Control, Addicks Dam	February 1978
Letter Report for Spillway Alternatives, Addicks and Barker Dams	March 1978
Construction Contract Drawings, Seepage Control, Addicks Dam	May 1978
Surface Traces of Geologic Faults in Areas of Addicks Dam	June 1978

Geologic Study of Faulting, Addicks Dam	June 1978
Construction Contract Drawings, Seepage Control, Barker Dam	August 1978
Construction Contract Drawings, Seepage Control, Addicks Dam	August 1978
Construction Contract Drawings, Seepage Control, Barker Dam	October 1978
Construction Contract Drawings, Gate Painting and Structural Repairs, Addicks and Barker Dams	August 1979
Emergency Operations Drawings for Foundation Observers, Addicks and Barker Dams	September 1979
Evaluation of Slurry Trench Collapse, Barker Dam	August 1980
Environmental Assessment, Dam Safety, Addicks and Barker Dam	November 1981
Geotechnical Investigation, Seepage Control, Slurry Trench Stability, Barker Dam	April 1982
(Periodic) Inspection Report No. 4, Buffalo Bayou and Tributaries, Addicks and Barker Dams	September 1982
Emergency Seepage Control Construction Completion Report, Buffalo Bayou and Tributaries, Addicks and Barker Dams, Texas	March 1983
Environmental Assessment, Two-Phased Improvements to Elridge Road, Addicks Dam	July 1983
Geotechnical Investigations, Clodine Ditch Improvements Study No. 2, Barker Dam	March 1984
Dam Safety Assurance General Design Memorandum, Buffalo Bayou and Tributaries, Texas, Addicks and Barker Dams	June 1984
Geotechnical Investigations, Clodine Ditch Improvements Study No. 2, Barker Dam	July 1984
Dam Safety Assurance; Supplement No. 1 to General Design Memorandum, Buffalo Bayou and Tributaries, Texas, Addicks and Barker Dams	December 1985
Environmental Assessment, Dam Safety Assurance, Addicks and Barker Dams	December 1985
Geotechnical Investigation, Clodine Ditch Addendum, Barker Dam	March 1986

Construction Contract Drawings, Dam Safety Assurance, Barker Dam	April 1986
Construction Contract Drawings, Raise Main Dam, Addicks Dam	May 1986
Design Memorandum No. 3 - Master Plan Update, Addicks and Barker Reservoirs, Buffalo Bayou Watershed, Houston, Texas	June 1986
Construction Contract Drawings, Armor Plate Ends, Addicks and Barker Dams	April 1987
(Periodic) Inspection Report No. 5, Buffalo Bayou and Tributaries, Addicks Dam	May 1987
(Periodic) Inspection Report No. 5, Buffalo Bayou and Tributaries, Barker Dam	May 1987
Construction Contract Drawings, Periodic Inspection Repairs, Addicks and Barker Dams	December 1987
Construction Contract Drawings, T-Wall at Outlet, Addicks Dam	March 1988
Construction Contract Drawings, T-Wall at Outlet, Barker Dam	January 1989
Construction Contract Drawings, Aesthetic Improvements, Addicks and Barker Dams	April 1989
Construction Contract Drawings, Repairs to RCC, Addicks and Barker Dams	May 1990
(Periodic) Inspection Report No. 6, Buffalo Bayou and Tributaries, Addicks Dam	September 1992
(Periodic) Inspection Report No. 6, Buffalo Bayou and Tributaries, Barker Dam	September 1992
Reconnaissance Report, Section 216 Study, Addicks and Barker Reservoirs, Buffalo Bayou and Tributaries, Houston, Texas	October 1995
Construction Contract Drawings, Embankment Restoration, Addicks and Barker Dams	September 1996
Construction Contract Drawings, Repairs to Barker Ditch and Outfall, Barker Dam	January 1997
Construction Contract Drawings, Embankment Restoration, Addicks and Barker Dams	February 1997

(Periodic) Inspection Report No. 7, Buffalo Bayou and Tributaries, Addicks Dam	October 1997
(Periodic) Inspection Report No. 7, Buffalo Bayou and Tributaries, Barker Dam	October 1997
Emergency Operations Plan, Addicks and Barker Dams	August 2000
Annual Inspection Report, Addicks and Barker Dams	May 2001
Construction Contract Drawings, Repairs to RCC	August 2002
(Periodic) Inspection Report No. 8, Buffalo Bayou and Tributaries, Addicks Dam	May 2003
(Periodic) Inspection Report No. 8, Buffalo Bayou and Tributaries, Barker Dam	May 2003
2003 Instrumentation Summary, Addicks and Barker Dams	January 2004
Construction Contract Drawings, Emergency Embankment Restoration, Addicks Dam	July 2004
2004 Instrumentation Summary, Addicks and Barker Dams	January 2005
2005, Instrumentation Summary, Addicks and Barker Dams	May 2006
2006, Instrumentation Summary, Addicks and Barker Dams	March 2007
(Periodic) Inspection Report No. 9, Buffalo Bayou and Tributaries, Addicks Dam	June 2007
(Periodic) Inspection Report No. 9, Buffalo Bayou and Tributaries, Barker Dam	June 2007
Construction Contract Drawings, Clodine Ditch Rehabilitation, Barker Dam	May 2008
Specifications, Clodine Ditch Rehabilitation, Barker Dam	May 2008
Outlet Structure Inspection and Report (Draft), Addicks and Barker Dams	August 2008
Aquatrack Geophysical Investigation (Draft), Addicks and Barker Dams	November 2008
2008 Instrumentation Summary	February 2009

Construction Contract Drawings, Conduit Void Repair, Addicks and Barker Dams	May 2009
Specifications, Conduit Void Repairs, Addicks and Barker Dams	May 2009
Galveston District Emergency Operations Plan, Annex I, Addicks & Barker Emergency Action Plan	August 2006
2009 Master Plan Addicks and Barker Reservoirs, Buffalo Bayou And Tributaries, Fort Bend and Harris Counties, Texas	August 2009
Addicks and Barker Pool Probability Analysis, US Army Corps Of Engineers, Galveston District	October 2011
Addicks and Barker Reservoirs, Buffalo Bayou and Tributaries, San Jacinto River Basin, Texas, Water Control Manual	November 2012
Interim Risk Reduction Measures Plan, Addicks Dam, Texas	February 2010
Interim Risk Reduction Measures Plan, Barker Dam, Texas	February 2010
Updated Interim Risk Reduction Measures Plan, Addicks Dam, Texas	April 2013
Updated Interim Risk Reduction Measures Plan, Barker Dam, Texas	April 2013
Addicks and Barker Dam Safety Modification Report	May 2013
Emergency Action Plan, Addicks Reservoir and Barker Reservoir, Buffalo Bayou and Tributaries	June 2018
New Outlet Structures and Cutoff Walls, Addicks Dam, Volume 1	June 2015
New Outlet Structures and Cutoff Walls, Barker Dam, Volume 2	June 2015
Specifications, W9126G-15-C-9937	June 2015
Design Documentation Report	July 2015
Engineering Considerations and Instructions to Field Personnel	February 2016

Table 7-01

Elevation-Area/Capacity Table - Addicks Reservoir

Elevation (ft) NAVD 1988	Area (acres) Capacity (Ac-ft) 0	Area (acres) Capacity (Ac-ft) 0.01	Area (acres) Capacity (Ac-ft) 0.02	Area (acres) Capacity (Ac-ft) 0.03	Area (acres) Capacity (Ac-ft) 0.04	Area (acres) Capacity (Ac-ft) 0.05	Area (acres) Capacity (Ac-ft) 0.06	Area (acres) Capacity (Ac-ft) 0.07	Area (acres) Capacity (Ac-ft) 0.08	Area (acres) Capacity (Ac-ft) 0.09
66	6 25	6 26	6 26	6 26	6 26	6 26	6 26	6 26	6 26	6 26
66.1	6 26	6 26	6 26	6 26	6 26	6 26	6 26	6 26	6 27	6 27
66.2	6 27	6 27	6 27	6 27	6 27	6 27	6 27	6 27	6 27	6 27
66.3	6 27	6 27	6 27	6 27	6 28	6 28	6 28	6 28	6 28	6 28
66.4	6 28	6 28	6 28	6 28	6 28	6 28	6 28	6 28	6 28	6 28
66.5	6 29	6 29	6 29	6 29	6 29	6 29	6 29	6 29	6 29	6 29
66.6	7 29	7 29	7 29	7 29	7 29	7 30	7 30	7 30	7 30	7 30
66.7	7 30	7 30	7 30	7 30	7 30	7 30	7 30	7 30	7 30	7 30
66.8	7 31	7 31	7 31	7 31	7 31	7 31	7 31	7 31	7 31	7 31
66.9	7 31	7 31	7 31	7 31	7 31	7 32	7 32	7 32	7 32	7 32
67	7 32	7 32	7 32	7 32	7 32	7 32	7 32	7 32	7 32	7 33
67.1	7 33	7 33	7 33	7 33	7 33	7 33	7 33	7 33	7 33	7 33
67.2	7 33	7 33	7 33	7 34	7 34	7 34	7 34	7 34	7 34	7 34
67.3	7 34	7 34	7 34	7 34	7 34	7 34	7 34	7 34	7 35	7 35
67.4	7 35	7 35	7 35	7 35	7 35	7 35	7 35	7 35	7 35	7 35
67.5	7 35	7 36	7 36	7 36	7 36	7 36	7 36	7 36	7 36	7 36
67.6	7 36	7 36	7 36	7 36	7 36	7 37	7 37	7 37	7 37	7 37
67.7	7 37	7 37	7 37	7 37	7 37	7 37	7 37	7 37	7 37	7 38
67.8	7 38	7 38	7 38	7 38	7 38	7 38	7 38	7 38	7 38	7 38
67.9	7 38	7 38	7 38	7 39	7 39	7 39	7 39	7 39	7 39	7 39

Table 7-01

Elevation-Area/Capacity Table - Addicks Reservoir

Elevation (ft) NAVD 1988	Area (acres) Capacity (Ac-ft) 0	Area (acres) Capacity (Ac-ft) 0.01	Area (acres) Capacity (Ac-ft) 0.02	Area (acres) Capacity (Ac-ft) 0.03	Area (acres) Capacity (Ac-ft) 0.04	Area (acres) Capacity (Ac-ft) 0.05	Area (acres) Capacity (Ac-ft) 0.06	Area (acres) Capacity (Ac-ft) 0.07	Area (acres) Capacity (Ac-ft) 0.08	Area (acres) Capacity (Ac-ft) 0.09
68	7 39	7 39	7 39	7 39	7 39	7 39	7 39	7 40	7 40	7 40
68.1	7 40	7 40	7 40	7 40	7 40	7 40	7 40	7 40	7 40	7 40
68.2	7 41	7 41	7 41	7 41	7 41	7 41	7 41	7 41	7 41	7 41
68.3	7 41	7 41	7 41	7 42	8 42	8 42	8 42	8 42	8 42	8 42
68.4	8 42	8 42	8 42	8 42	8 42	8 42	8 42	8 43	8 43	8 43
68.5	8 43	8 43	8 43	8 43	8 43	8 43	8 43	8 43	8 43	8 43
68.6	8 44	8 44	8 44	8 44	8 44	8 44	8 44	8 44	8 44	8 44
68.7	8 44	8 44	8 44	8 45	8 45	8 45	8 45	8 45	8 45	8 45
68.8	8 45	8 45	8 45	8 45	8 45	8 45	8 46	8 46	8 46	8 46
68.9	8 46	8 46	8 46	8 46	8 46	8 46	8 46	8 46	8 46	8 47
69	8 47	8 47	8 47	8 47	8 47	8 47	8 47	8 47	8 47	8 47
69.1	8 47	8 47	8 48	8 48	8 48	8 48	8 48	8 48	8 48	8 48
69.2	8 48	8 48	8 48	8 48	8 49	8 49	8 49	8 49	8 49	8 49
69.3	8 49	8 49	8 49	8 49	8 49	8 49	8 49	8 50	8 50	8 50
69.4	8 50	8 50	8 50	8 50	8 50	8 50	8 50	8 50	8 50	8 50
69.5	8 51	8 51	8 51	8 51	8 51	8 51	8 51	8 51	8 51	8 51
69.6	8 51	8 51	8 52	8 52	8 52	8 52	8 52	8 52	8 52	8 52
69.7	8 52	8 52	8 52	8 52	8 52	8 53	8 53	8 53	8 53	8 53
69.8	8 53	8 53	8 53	8 53	8 53	8 53	8 53	8 54	8 54	8 54
69.9	8 54	8 54	8 54	8 54	8 54	8 54	8 54	8 54	8 54	8 55

Table 7-01

Elevation-Area/Capacity Table - Addicks Reservoir

Elevation (ft) NAVD 1988	Area (acres) Capacity (Ac-ft) 0	Area (acres) Capacity (Ac-ft) 0.01	Area (acres) Capacity (Ac-ft) 0.02	Area (acres) Capacity (Ac-ft) 0.03	Area (acres) Capacity (Ac-ft) 0.04	Area (acres) Capacity (Ac-ft) 0.05	Area (acres) Capacity (Ac-ft) 0.06	Area (acres) Capacity (Ac-ft) 0.07	Area (acres) Capacity (Ac-ft) 0.08	Area (acres) Capacity (Ac-ft) 0.09
70	8 55	8 55	8 55	8 55	8 55	8 55	8 55	8 55	8 55	8 55
70.1	8 55	8 55	8 56	8 56	8 56	8 56	8 56	8 56	8 56	8 56
70.2	8 56	8 56	8 56	8 56	8 57	8 57	8 57	8 57	8 57	8 57
70.3	8 57	8 57	8 57	8 57	8 57	8 57	8 58	8 58	8 58	8 58
70.4	8 58	8 58	8 58	8 58	8 58	8 58	8 58	8 58	8 59	8 59
70.5	8 59	8 59	8 59	8 59	8 59	8 59	8 59	8 59	8 59	8 59
70.6	8 60	8 60	8 60	8 60	8 60	8 60	8 60	8 60	8 60	8 60
70.7	8 60	8 60	8 61	8 61	8 61	8 61	8 61	8 61	8 61	8 61
70.8	8 61	8 61	8 61	8 61	8 62	8 62	8 62	8 62	8 62	8 62
70.9	8 62	9 62	9 62	9 62	9 62	9 62	9 63	9 63	9 63	9 63
71	9 63	9 63	9 63	9 63	9 63	9 63	9 63	9 64	9 64	9 64
71.1	9 64	9 64	9 64	9 64	9 64	9 64	9 64	9 64	9 64	9 65
71.2	9 65	9 65	9 65	9 65	9 65	9 65	9 65	9 65	9 65	9 65
71.3	9 66	9 66	9 66	9 66	9 66	9 66	9 66	9 66	9 66	9 66
71.4	9 66	9 66	9 67	9 67	9 67	9 67	9 67	9 67	9 67	9 67
71.5	9 67	9 67	9 67	9 68	9 68	9 68	9 68	9 68	9 68	9 68
71.6	9 68	9 68	9 68	9 68	9 68	9 69	9 69	9 69	9 69	9 69
71.7	9 69	9 69	9 69	9 69	9 69	9 69	9 70	9 70	9 70	9 70
71.8	9 70	9 70	9 70	9 70	9 70	9 70	9 70	9 70	9 71	9 71
71.9	9 71	9 71	9 71	9 71	9 71	9 71	9 71	9 71	9 71	9 72

Table 7-01

Elevation-Area/Capacity Table - Addicks Reservoir

Elevation (ft) NAVD 1988	Area (acres) Capacity (Ac-ft) 0	Area (acres) Capacity (Ac-ft) 0.01	Area (acres) Capacity (Ac-ft) 0.02	Area (acres) Capacity (Ac-ft) 0.03	Area (acres) Capacity (Ac-ft) 0.04	Area (acres) Capacity (Ac-ft) 0.05	Area (acres) Capacity (Ac-ft) 0.06	Area (acres) Capacity (Ac-ft) 0.07	Area (acres) Capacity (Ac-ft) 0.08	Area (acres) Capacity (Ac-ft) 0.09
72	9 72	9 72	9 72	9 72	9 72	9 72	9 72	9 72	9 72	9 72
72.1	9 73	9 73	9 73	9 73	9 73	9 73	9 73	9 73	9 73	9 73
72.2	9 73	9 74	9 74	9 74	9 74	9 74	9 74	9 74	9 74	9 74
72.3	9 74	9 74	9 75	9 75	9 75	9 75	9 75	9 75	9 75	9 75
72.4	9 75	9 75	9 75	9 76	9 76	9 76	9 76	9 76	9 76	9 76
72.5	9 76	9 76	9 76	9 76	9 77	9 77	9 77	9 77	9 77	9 77
72.6	9 77	9 77	9 77	9 77	9 77	9 78	9 78	9 78	9 78	9 78
72.7	9 78	9 78	9 78	9 78	9 78	9 78	9 79	9 79	9 79	9 79
72.8	9 79	9 79	9 79	9 79	9 79	9 79	9 79	9 80	9 80	9 80
72.9	9 80	9 80	9 80	9 80	9 80	9 80	9 80	9 80	9 81	9 81
73	9 81	9 81	9 81	9 81	9 81	9 81	9 81	9 81	9 82	9 82
73.1	9 82	9 82	9 82	9 82	9 82	9 82	9 82	9 82	9 82	9 83
73.2	9 83	9 83	9 83	9 83	9 83	9 83	9 83	9 83	9 83	9 84
73.3	9 84	9 84	9 84	9 84	9 84	9 84	9 84	9 84	9 84	9 84
73.4	9 85	9 85	9 85	9 85	9 85	9 85	9 85	9 85	9 85	10 85
73.5	10 86	10 86	10 86	10 86	10 86	10 86	10 86	10 86	10 86	10 86
73.6	10 86	10 87	10 87	10 87	10 87	10 87	10 87	10 87	10 87	10 87
73.7	10 87	10 88	10 88	10 88	10 88	10 88	10 88	10 88	10 88	10 88
73.8	10 88	10 88	10 89	10 89	10 89	10 89	10 89	10 89	10 89	10 89
73.9	10 89	10 89	10 90	10 90	10 90	10 90	10 90	10 90	10 90	10 90

Table 7-01

Elevation-Area/Capacity Table - Addicks Reservoir

Elevation (ft) NAVD 1988	Area (acres) Capacity (Ac-ft) 0	Area (acres) Capacity (Ac-ft) 0.01	Area (acres) Capacity (Ac-ft) 0.02	Area (acres) Capacity (Ac-ft) 0.03	Area (acres) Capacity (Ac-ft) 0.04	Area (acres) Capacity (Ac-ft) 0.05	Area (acres) Capacity (Ac-ft) 0.06	Area (acres) Capacity (Ac-ft) 0.07	Area (acres) Capacity (Ac-ft) 0.08	Area (acres) Capacity (Ac-ft) 0.09
74	10 90	10 90	10 90	10 91	10 91	10 91	10 91	10 91	10 91	10 91
74.1	11 91	11 91	11 92	11 92	11 92	11 92	11 92	11 92	11 92	11 92
74.2	11 92	12 93	12 93	12 93	12 93	12 93	12 93	12 93	12 93	12 93
74.3	12 94	13 94	13 94	13 94	13 94	13 94	13 94	13 95	13 95	13 95
74.4	13 95	14 95	14 95	14 95	14 95	14 96	14 96	14 96	14 96	14 96
74.5	14 96	15 96	15 97	15 97	15 97	15 97	15 97	15 97	15 97	15 98
74.6	16 98	16 98	16 98	16 98	16 98	16 99	16 99	16 99	16 99	17 99
74.7	17 99	17 100	17 100	17 100	17 100	17 100	17 100	17 101	18 101	18 101
74.8	18 101	18 101	18 101	18 102	18 102	18 102	18 102	19 102	19 103	19 103
74.9	19 103	19 103	19 103	19 104	19 104	20 104	20 104	20 104	20 105	20 105
75	20 105	20 105	20 105	20 105	20 106	20 106	20 106	20 106	20 107	20 107
75.1	20 107	21 107	21 107	21 108	21 108	21 108	21 108	21 108	21 109	21 109
75.2	21 109	21 109	21 109	21 110	21 110	21 110	21 110	21 110	21 111	21 111
75.3	21 111	21 111	21 112	21 112	21 112	21 112	21 112	21 113	21 113	21 113
75.4	21 113	21 113	21 114	21 114	22 114	22 114	22 114	22 115	22 115	22 115
75.5	22 115	22 116	22 116	22 116	22 116	22 116	22 117	22 117	22 117	22 117
75.6	22 118	22 118	22 118	22 118	22 118	22 119	22 119	22 119	22 119	22 120
75.7	22 120	22 120	22 120	22 120	22 121	22 121	23 121	23 121	23 122	23 122
75.8	23 122	23 122	23 122	23 123	23 123	23 123	23 123	23 124	23 124	23 124
75.9	23 124	23 125	23 125	23 125	23 125	23 125	23 126	23 126	23 126	23 126

Table 7-01

Elevation-Area/Capacity Table - Addicks Reservoir

Elevation (ft) NAVD 1988	Area (acres) Capacity (Ac-ft) 0	Area (acres) Capacity (Ac-ft) 0.01	Area (acres) Capacity (Ac-ft) 0.02	Area (acres) Capacity (Ac-ft) 0.03	Area (acres) Capacity (Ac-ft) 0.04	Area (acres) Capacity (Ac-ft) 0.05	Area (acres) Capacity (Ac-ft) 0.06	Area (acres) Capacity (Ac-ft) 0.07	Area (acres) Capacity (Ac-ft) 0.08	Area (acres) Capacity (Ac-ft) 0.09
76	23 127	23 127	23 127	23 127	23 128	23 128	23 128	23 128	23 128	23 129
76.1	24 129	24 129	24 129	24 130	24 130	24 130	24 130	24 131	24 131	24 131
76.2	24 131	24 132	24 132	24 132	24 132	24 132	24 133	24 133	24 133	24 133
76.3	24 134	24 134	24 134	24 134	24 135	24 135	24 135	24 135	24 136	24 136
76.4	24 136	24 136	24 137	24 137	24 137	24 137	24 138	24 138	24 138	24 138
76.5	24 139	24 139	24 139	24 139	25 140	25 140	25 140	25 140	25 140	25 141
76.6	25 141	25 141	25 141	25 142	25 142	25 142	25 142	25 143	25 143	25 143
76.7	25 143	25 144	25 144	25 144	25 144	25 145	25 145	25 145	25 145	25 146
76.8	25 146	25 146	25 146	25 147	25 147	25 147	25 147	25 148	25 148	25 148
76.9	25 148	25 149	25 149	25 149	25 150	25 150	26 150	26 150	26 151	26 151
77	26 151	26 151	26 152	27 152	27 152	27 152	28 153	28 153	29 153	29 153
77.1	29 154	30 154	30 154	30 155	31 155	31 155	32 156	32 156	32 156	33 157
77.2	33 157	34 157	34 158	35 158	35 158	35 159	36 159	36 159	37 160	37 160
77.3	38 160	38 161	38 161	39 162	39 162	40 162	40 163	41 163	41 164	42 164
77.4	42 164	42 165	43 165	43 166	44 166	44 167	45 167	45 167	46 168	46 168
77.5	47 169	47 169	48 170	48 170	49 171	49 171	50 172	50 172	51 173	51 173
77.6	52 174	52 174	53 175	53 175	54 176	54 176	55 177	55 178	56 178	56 179
77.7	57 179	57 180	58 180	59 181	59 182	60 182	60 183	61 183	61 184	62 185
77.8	62 185	63 186	64 186	64 187	65 188	65 188	66 189	66 190	67 190	68 191
77.9	68 192	69 192	69 193	70 194	70 194	71 195	72 196	72 197	73 197	73 198

Table 7-01

Elevation-Area/Capacity Table - Addicks Reservoir

Elevation (ft) NAVD 1988	Area (acres) Capacity (Ac-ft) 0	Area (acres) Capacity (Ac-ft) 0.01	Area (acres) Capacity (Ac-ft) 0.02	Area (acres) Capacity (Ac-ft) 0.03	Area (acres) Capacity (Ac-ft) 0.04	Area (acres) Capacity (Ac-ft) 0.05	Area (acres) Capacity (Ac-ft) 0.06	Area (acres) Capacity (Ac-ft) 0.07	Area (acres) Capacity (Ac-ft) 0.08	Area (acres) Capacity (Ac-ft) 0.09
78	74 199	75 200	76 200	77 201	79 202	80 203	81 203	82 204	83 205	84 206
78.1	86 207	87 208	88 209	89 209	90 210	92 211	93 212	94 213	95 214	97 215
78.2	98 216	99 217	100 218	102 219	103 220	104 221	106 222	107 223	108 224	110 225
78.3	111 226	112 227	114 229	115 230	117 231	118 232	119 233	121 234	122 236	124 237
78.4	125 238	126 239	128 241	129 242	131 243	132 245	134 246	135 247	137 249	138 250
78.5	140 251	141 253	143 254	144 256	146 257	148 259	149 260	151 262	152 263	154 265
78.6	155 266	157 268	159 269	160 271	162 273	164 274	165 276	167 277	169 279	170 281
78.7	172 283	174 284	175 286	177 288	179 290	180 291	182 293	184 295	186 297	187 299
78.8	189 301	191 302	193 304	194 306	196 308	198 310	200 312	202 314	204 316	205 318
78.9	207 320	209 322	211 325	213 327	215 329	217 331	219 333	220 335	222 338	224 340
79	226 342	227 344	228 347	228 349	229 351	230 353	230 356	231 358	232 360	233 363
79.1	233 365	234 367	235 370	235 372	236 374	237 377	238 379	238 382	239 384	240 386
79.2	240 389	241 391	242 394	243 396	243 398	244 401	245 403	245 406	246 408	247 411
79.3	248 413	248 416	249 418	250 421	251 423	251 426	252 428	253 431	254 433	254 436
79.4	255 438	256 441	256 443	257 446	258 448	259 451	259 454	260 456	261 459	262 461
79.5	262 464	263 467	264 469	265 472	265 475	266 477	267 480	268 483	269 485	269 488
79.6	270 491	271 493	272 496	272 499	273 502	274 504	275 507	275 510	276 513	277 515
79.7	278 518	279 521	279 524	280 526	281 529	282 532	282 535	283 538	284 541	285 543
79.8	286 546	286 549	287 552	288 555	289 558	289 561	290 564	291 566	292 569	293 572
79.9	293 575	294 578	295 581	296 584	297 587	297 590	298 593	299 596	300 599	301 602

Table 7-01

Elevation-Area/Capacity Table - Addicks Reservoir

Elevation (ft) NAVD 1988	Area (acres) Capacity (Ac-ft) 0	Area (acres) Capacity (Ac-ft) 0.01	Area (acres) Capacity (Ac-ft) 0.02	Area (acres) Capacity (Ac-ft) 0.03	Area (acres) Capacity (Ac-ft) 0.04	Area (acres) Capacity (Ac-ft) 0.05	Area (acres) Capacity (Ac-ft) 0.06	Area (acres) Capacity (Ac-ft) 0.07	Area (acres) Capacity (Ac-ft) 0.08	Area (acres) Capacity (Ac-ft) 0.09
80	301 605	302 608	303 611	303 614	304 617	305 620	305 623	306 626	307 629	307 632
80.1	308 635	309 639	309 642	310 645	311 648	311 651	312 654	313 657	313 660	314 663
80.2	315 667	316 670	316 673	317 676	318 679	318 682	319 686	320 689	320 692	321 695
80.3	322 698	322 702	323 705	324 708	324 711	325 715	326 718	326 721	327 724	328 728
80.4	329 731	329 734	330 738	331 741	331 744	332 747	333 751	333 754	334 757	335 761
80.5	335 764	336 767	337 771	338 774	338 778	339 781	340 784	340 788	341 791	342 795
80.6	342 798	343 801	344 805	345 808	345 812	346 815	347 819	347 822	348 826	349 829
80.7	350 833	350 836	351 840	352 843	352 847	353 850	354 854	355 857	355 861	356 864
80.8	357 868	357 871	358 875	359 879	360 882	360 886	361 889	362 893	363 897	363 900
80.9	364 904	365 908	365 911	366 915	367 919	368 922	368 926	369 930	370 933	371 937
81	371 941	372 944	373 948	374 952	375 956	376 959	377 963	377 967	378 971	379 974
81.1	380 978	381 982	382 986	383 990	384 994	384 997	385 1001	386 1005	387 1009	388 1013
81.2	389 1017	390 1021	391 1025	392 1028	393 1032	393 1036	394 1040	395 1044	396 1048	397 1052
81.3	398 1056	399 1060	400 1064	401 1068	402 1072	402 1076	403 1080	404 1084	405 1088	406 1092
81.4	407 1096	408 1100	409 1104	410 1109	411 1113	412 1117	412 1121	413 1125	414 1129	415 1133
81.5	416 1137	417 1142	418 1146	419 1150	420 1154	421 1158	422 1163	423 1167	424 1171	425 1175
81.6	425 1180	426 1184	427 1188	428 1192	429 1197	430 1201	431 1205	432 1210	433 1214	434 1218
81.7	435 1223	436 1227	437 1231	438 1236	439 1240	440 1244	441 1249	441 1253	442 1258	443 1262
81.8	444 1267	445 1271	446 1275	447 1280	448 1284	449 1289	450 1293	451 1298	452 1302	453 1307
81.9	454 1311	455 1316	456 1321	457 1325	458 1330	459 1334	460 1339	461 1343	462 1348	463 1353

Table 7-01

Elevation-Area/Capacity Table - Addicks Reservoir

Elevation (ft) NAVD 1988	Area (acres) Capacity (Ac-ft) 0	Area (acres) Capacity (Ac-ft) 0.01	Area (acres) Capacity (Ac-ft) 0.02	Area (acres) Capacity (Ac-ft) 0.03	Area (acres) Capacity (Ac-ft) 0.04	Area (acres) Capacity (Ac-ft) 0.05	Area (acres) Capacity (Ac-ft) 0.06	Area (acres) Capacity (Ac-ft) 0.07	Area (acres) Capacity (Ac-ft) 0.08	Area (acres) Capacity (Ac-ft) 0.09
82	464 1357	465 1362	466 1367	468 1371	469 1376	471 1381	472 1385	473 1390	475 1395	476 1400
82.1	478 1404	479 1409	480 1414	482 1419	483 1424	485 1428	486 1433	487 1438	489 1443	490 1448
82.2	492 1453	493 1458	495 1463	496 1468	497 1473	499 1478	500 1483	502 1488	503 1493	505 1498
82.3	506 1503	508 1508	509 1513	510 1518	512 1523	513 1528	515 1533	516 1539	518 1544	519 1549
82.4	521 1554	522 1559	524 1565	525 1570	527 1575	528 1580	530 1586	531 1591	533 1596	534 1602
82.5	536 1607	537 1612	539 1618	540 1623	542 1628	543 1634	545 1639	546 1645	548 1650	549 1656
82.6	551 1661	552 1667	554 1672	555 1678	557 1683	558 1689	560 1695	561 1700	563 1706	564 1711
82.7	566 1717	567 1723	569 1728	570 1734	572 1740	573 1745	575 1751	577 1757	578 1763	580 1769
82.8	581 1774	583 1780	584 1786	586 1792	587 1798	589 1804	591 1810	592 1815	594 1821	595 1827
82.9	597 1833	598 1839	600 1845	602 1851	603 1857	605 1863	606 1869	608 1875	609 1881	611 1888
83	613 1894	615 1900	617 1906	619 1912	621 1918	623 1925	626 1931	628 1937	630 1943	632 1950
83.1	634 1956	636 1962	639 1969	641 1975	643 1982	645 1988	647 1995	650 2001	652 2007	654 2014
83.2	656 2021	658 2027	661 2034	663 2040	665 2047	667 2054	670 2060	672 2067	674 2074	676 2081
83.3	679 2087	681 2094	683 2101	685 2108	688 2115	690 2122	692 2128	695 2135	697 2142	699 2149
83.4	701 2156	704 2163	706 2170	708 2177	711 2185	713 2192	715 2199	718 2206	720 2213	722 2220
83.5	725 2228	727 2235	729 2242	732 2249	734 2257	736 2264	739 2271	741 2279	743 2286	746 2294
83.6	748 2301	750 2309	753 2316	755 2324	758 2331	760 2339	762 2347	765 2354	767 2362	769 2370
83.7	772 2377	774 2385	777 2393	779 2400	782 2408	784 2416	786 2424	789 2432	791 2440	794 2448
83.8	796 2456	799 2464	801 2472	803 2480	806 2488	808 2496	811 2504	813 2512	816 2520	818 2528
83.9	821 2536	823 2545	826 2553	828 2561	831 2569	833 2578	836 2586	838 2595	841 2603	843 2611

Table 7-01

Elevation-Area/Capacity Table - Addicks Reservoir

Elevation (ft) NAVD 1988	Area (acres) Capacity (Ac-ft) 0	Area (acres) Capacity (Ac-ft) 0.01	Area (acres) Capacity (Ac-ft) 0.02	Area (acres) Capacity (Ac-ft) 0.03	Area (acres) Capacity (Ac-ft) 0.04	Area (acres) Capacity (Ac-ft) 0.05	Area (acres) Capacity (Ac-ft) 0.06	Area (acres) Capacity (Ac-ft) 0.07	Area (acres) Capacity (Ac-ft) 0.08	Area (acres) Capacity (Ac-ft) 0.09
84	846 2620	849 2628	852 2637	855 2645	859 2654	862 2662	865 2671	868 2680	871 2688	875 2697
84.1	878 2706	881 2715	884 2724	888 2732	891 2741	894 2750	898 2759	901 2768	904 2777	907 2786
84.2	911 2795	914 2805	917 2814	921 2823	924 2832	927 2841	931 2851	934 2860	937 2869	941 2879
84.3	944 2888	948 2898	951 2907	954 2917	958 2926	961 2936	965 2945	968 2955	971 2965	975 2974
84.4	978 2984	982 2994	985 3004	989 3014	992 3024	995 3034	999 3044	1002 3054	1006 3064	1009 3074
84.5	1013 3084	1016 3094	1020 3104	1023 3114	1027 3125	1030 3135	1034 3145	1037 3156	1041 3166	1045 3176
84.6	1048 3187	1052 3197	1055 3208	1059 3218	1062 3229	1066 3240	1069 3250	1073 3261	1077 3272	1080 3283
84.7	1084 3293	1087 3304	1091 3315	1095 3326	1098 3337	1102 3348	1106 3359	1109 3370	1113 3381	1117 3392
84.8	1120 3404	1124 3415	1128 3426	1131 3437	1135 3449	1139 3460	1142 3472	1146 3483	1150 3494	1154 3506
84.9	1157 3518	1161 3529	1165 3541	1169 3552	1172 3564	1176 3576	1180 3588	1184 3599	1187 3611	1191 3623
85	1195 3635	1199 3647	1203 3659	1207 3671	1211 3683	1215 3695	1219 3708	1223 3720	1227 3732	1231 3744
85.1	1235 3757	1239 3769	1243 3781	1247 3794	1251 3806	1255 3819	1259 3831	1263 3844	1267 3857	1271 3869
85.2	1275 3882	1279 3895	1283 3908	1288 3921	1292 3933	1296 3946	1300 3959	1304 3972	1308 3985	1312 3999
85.3	1316 4012	1321 4025	1325 4038	1329 4051	1333 4065	1337 4078	1341 4091	1346 4105	1350 4118	1354 4132
85.4	1358 4145	1362 4159	1367 4173	1371 4186	1375 4200	1379 4214	1384 4228	1388 4242	1392 4255	1396 4269
85.5	1401 4283	1405 4297	1409 4311	1413 4326	1418 4340	1422 4354	1426 4368	1431 4382	1435 4397	1439 4411
85.6	1444 4426	1448 4440	1452 4454	1457 4469	1461 4484	1465 4498	1470 4513	1474 4528	1479 4542	1483 4557
85.7	1487 4572	1492 4587	1496 4602	1501 4617	1505 4632	1509 4647	1514 4662	1518 4677	1523 4692	1527 4708
85.8	1532 4723	1536 4738	1541 4754	1545 4769	1550 4785	1554 4800	1559 4816	1563 4831	1568 4847	1572 4863
85.9	1577 4878	1581 4894	1586 4910	1590 4926	1595 4942	1600 4958	1604 4974	1609 4990	1613 5006	1618 5022

Table 7-01

Elevation-Area/Capacity Table - Addicks Reservoir

Elevation (ft) NAVD 1988	Area (acres) Capacity (Ac-ft) 0	Area (acres) Capacity (Ac-ft) 0.01	Area (acres) Capacity (Ac-ft) 0.02	Area (acres) Capacity (Ac-ft) 0.03	Area (acres) Capacity (Ac-ft) 0.04	Area (acres) Capacity (Ac-ft) 0.05	Area (acres) Capacity (Ac-ft) 0.06	Area (acres) Capacity (Ac-ft) 0.07	Area (acres) Capacity (Ac-ft) 0.08	Area (acres) Capacity (Ac-ft) 0.09
86	1622 5038	1627 5055	1632 5071	1636 5087	1641 5104	1646 5120	1651 5137	1655 5153	1660 5170	1665 5186
86.1	1669 5203	1674 5220	1679 5236	1684 5253	1688 5270	1693 5287	1698 5304	1703 5321	1707 5338	1712 5355
86.2	1717 5372	1722 5390	1727 5407	1731 5424	1736 5441	1741 5459	1746 5476	1751 5494	1756 5511	1760 5529
86.3	1765 5546	1770 5564	1775 5582	1780 5600	1785 5617	1790 5635	1795 5653	1799 5671	1804 5689	1809 5707
86.4	1814 5725	1819 5744	1824 5762	1829 5780	1834 5798	1839 5817	1844 5835	1849 5854	1854 5872	1859 5891
86.5	1864 5909	1869 5928	1874 5947	1879 5965	1884 5984	1889 6003	1894 6022	1899 6041	1904 6060	1909 6079
86.6	1914 6098	1919 6117	1924 6137	1929 6156	1934 6175	1939 6195	1945 6214	1950 6233	1955 6253	1960 6272
86.7	1965 6292	1970 6312	1975 6332	1980 6351	1986 6371	1991 6391	1996 6411	2001 6431	2006 6451	2011 6471
86.8	2017 6491	2022 6511	2027 6532	2032 6552	2037 6572	2043 6593	2048 6613	2053 6634	2058 6654	2064 6675
86.9	2069 6695	2074 6716	2079 6737	2085 6758	2090 6779	2095 6800	2101 6821	2106 6842	2111 6863	2116 6884
87	2122 6905	2127 6926	2133 6948	2138 6969	2144 6990	2149 7012	2155 7033	2161 7055	2166 7077	2172 7098
87.1	2177 7120	2183 7142	2188 7164	2194 7186	2200 7207	2205 7229	2211 7252	2216 7274	2222 7296	2228 7318
87.2	2233 7340	2239 7363	2245 7385	2250 7408	2256 7430	2262 7453	2267 7475	2273 7498	2279 7521	2285 7544
87.3	2290 7567	2296 7590	2302 7613	2307 7636	2313 7659	2319 7682	2325 7705	2331 7728	2336 7752	2342 7775
87.4	2348 7799	2354 7822	2359 7846	2365 7869	2371 7893	2377 7917	2383 7940	2389 7964	2394 7988	2400 8012
87.5	2406 8036	2412 8060	2418 8084	2424 8109	2430 8133	2436 8157	2442 8182	2447 8206	2453 8231	2459 8255
87.6	2465 8280	2471 8304	2477 8329	2483 8354	2489 8379	2495 8404	2501 8429	2507 8454	2513 8479	2519 8504
87.7	2525 8529	2531 8555	2537 8580	2543 8605	2549 8631	2555 8656	2561 8682	2567 8708	2573 8733	2579 8759
87.8	2585 8785	2591 8811	2598 8837	2604 8863	2610 8889	2616 8915	2622 8941	2628 8967	2634 8994	2640 9020
87.9	2647 9046	2653 9073	2659 9099	2665 9126	2671 9153	2677 9180	2684 9206	2690 9233	2696 9260	2702 9287

Table 7-01

Elevation-Area/Capacity Table - Addicks Reservoir

Elevation (ft) NAVD 1988	Area (acres) Capacity (Ac-ft) 0	Area (acres) Capacity (Ac-ft) 0.01	Area (acres) Capacity (Ac-ft) 0.02	Area (acres) Capacity (Ac-ft) 0.03	Area (acres) Capacity (Ac-ft) 0.04	Area (acres) Capacity (Ac-ft) 0.05	Area (acres) Capacity (Ac-ft) 0.06	Area (acres) Capacity (Ac-ft) 0.07	Area (acres) Capacity (Ac-ft) 0.08	Area (acres) Capacity (Ac-ft) 0.09
88	2708 9314	2714 9341	2720 9368	2727 9396	2733 9423	2739 9450	2745 9478	2751 9505	2757 9533	2763 9560
88.1	2769 9588	2775 9616	2781 9644	2787 9671	2793 9699	2800 9727	2806 9755	2812 9783	2818 9811	2824 9840
88.2	2830 9868	2836 9896	2843 9925	2849 9953	2855 9982	2861 10010	2867 10039	2874 10068	2880 10096	2886 10125
88.3	2892 10154	2898 10183	2905 10212	2911 10241	2917 10270	2923 10299	2930 10329	2936 10358	2942 10387	2948 10417
88.4	2955 10446	2961 10476	2967 10506	2974 10535	2980 10565	2986 10595	2993 10625	2999 10655	3005 10685	3012 10715
88.5	3018 10745	3024 10775	3031 10806	3037 10836	3043 10866	3050 10897	3056 10927	3063 10958	3069 10989	3075 11019
88.6	3082 11050	3088 11081	3095 11112	3101 11143	3108 11174	3114 11205	3121 11236	3127 11267	3134 11299	3140 11330
88.7	3147 11361	3153 11393	3160 11425	3166 11456	3173 11488	3179 11520	3186 11551	3192 11583	3199 11615	3205 11647
88.8	3212 11679	3218 11712	3225 11744	3231 11776	3238 11808	3245 11841	3251 11873	3258 11906	3264 11938	3271 11971
88.9	3278 12004	3284 12037	3291 12070	3298 12102	3304 12135	3311 12169	3318 12202	3324 12235	3331 12268	3338 12302
89	3344 12335	3351 12368	3358 12402	3365 12436	3372 12469	3379 12503	3386 12537	3393 12571	3400 12605	3407 12639
89.1	3414 12673	3421 12707	3428 12741	3435 12776	3442 12810	3449 12844	3456 12879	3463 12913	3470 12948	3477 12983
89.2	3484 13018	3491 13053	3498 13088	3505 13123	3512 13158	3519 13193	3526 13228	3533 13263	3540 13299	3547 13334
89.3	3555 13370	3562 13405	3569 13441	3576 13477	3583 13512	3590 13548	3597 13584	3605 13620	3612 13656	3619 13692
89.4	3626 13729	3633 13765	3641 13801	3648 13838	3655 13874	3662 13911	3669 13947	3677 13984	3684 14021	3691 14058
89.5	3698 14095	3706 14132	3713 14169	3720 14206	3727 14243	3735 14281	3742 14318	3749 14356	3757 14393	3764 14431
89.6	3771 14468	3779 14506	3786 14544	3793 14582	3801 14620	3808 14658	3815 14696	3823 14734	3830 14772	3838 14811
89.7	3845 14849	3852 14888	3860 14926	3867 14965	3875 15004	3882 15042	3889 15081	3897 15120	3904 15159	3912 15198
89.8	3919 15237	3927 15277	3934 15316	3942 15355	3949 15395	3957 15434	3964 15474	3972 15514	3979 15553	3987 15593
89.9	3994 15633	4002 15673	4010 15713	4017 15753	4025 15793	4032 15834	4040 15874	4047 15914	4055 15955	4063 15996

Table 7-01

Elevation-Area/Capacity Table - Addicks Reservoir

Elevation (ft) NAVD 1988	Area (acres) Capacity (Ac-ft) 0	Area (acres) Capacity (Ac-ft) 0.01	Area (acres) Capacity (Ac-ft) 0.02	Area (acres) Capacity (Ac-ft) 0.03	Area (acres) Capacity (Ac-ft) 0.04	Area (acres) Capacity (Ac-ft) 0.05	Area (acres) Capacity (Ac-ft) 0.06	Area (acres) Capacity (Ac-ft) 0.07	Area (acres) Capacity (Ac-ft) 0.08	Area (acres) Capacity (Ac-ft) 0.09
90	4070 16036	4077 16077	4084 16118	4091 16159	4098 16200	4105 16241	4113 16282	4120 16323	4127 16364	4134 16405
90.1	4141 16447	4148 16488	4155 16530	4162 16571	4169 16613	4176 16655	4184 16697	4191 16738	4198 16780	4205 16822
90.2	4212 16864	4219 16907	4226 16949	4234 16991	4241 17034	4248 17076	4255 17118	4262 17161	4270 17204	4277 17246
90.3	4284 17289	4291 17332	4298 17375	4306 17418	4313 17461	4320 17504	4327 17548	4335 17591	4342 17634	4349 17678
90.4	4357 17721	4364 17765	4371 17809	4378 17852	4386 17896	4393 17940	4400 17984	4408 18028	4415 18072	4422 18116
90.5	4430 18161	4437 18205	4444 18249	4452 18294	4459 18338	4466 18383	4474 18428	4481 18472	4489 18517	4496 18562
90.6	4503 18607	4511 18652	4518 18697	4526 18743	4533 18788	4540 18833	4548 18879	4555 18924	4563 18970	4570 19016
90.7	4578 19061	4585 19107	4593 19153	4600 19199	4608 19245	4615 19291	4623 19337	4630 19384	4638 19430	4645 19476
90.8	4653 19523	4660 19569	4668 19616	4675 19663	4683 19709	4690 19756	4698 19803	4705 19850	4713 19897	4721 19945
90.9	4728 19992	4736 20039	4743 20087	4751 20134	4758 20182	4766 20229	4774 20277	4781 20325	4789 20372	4797 20420
91	4804 20468	4812 20516	4820 20565	4827 20613	4835 20661	4843 20710	4850 20758	4858 20807	4866 20855	4873 20904
91.1	4881 20953	4889 21002	4897 21050	4904 21099	4912 21149	4920 21198	4928 21247	4935 21296	4943 21346	4951 21395
91.2	4959 21445	4967 21494	4974 21544	4982 21594	4990 21644	4998 21694	5006 21744	5013 21794	5021 21844	5029 21894
91.3	5037 21944	5045 21995	5053 22045	5060 22096	5068 22147	5076 22197	5084 22248	5092 22299	5100 22350	5108 22401
91.4	5116 22452	5124 22503	5131 22555	5139 22606	5147 22657	5155 22709	5163 22760	5171 22812	5179 22864	5187 22916
91.5	5195 22968	5203 23020	5211 23072	5219 23124	5227 23176	5235 23228	5243 23281	5251 23333	5259 23386	5267 23438
91.6	5275 23491	5283 23544	5291 23597	5299 23650	5307 23703	5315 23756	5323 23809	5331 23862	5339 23916	5348 23969
91.7	5356 24023	5364 24076	5372 24130	5380 24184	5388 24237	5396 24291	5404 24345	5412 24399	5421 24454	5429 24508
91.8	5437 24562	5445 24617	5453 24671	5461 24726	5470 24780	5478 24835	5486 24890	5494 24945	5502 25000	5510 25055
91.9	5519 25110	5527 25165	5535 25221	5543 25276	5552 25331	5560 25387	5568 25443	5576 25498	5585 25554	5593 25610

Table 7-01

Elevation-Area/Capacity Table - Addicks Reservoir

Elevation (ft) NAVD 1988	Area (acres) Capacity (Ac-ft) 0	Area (acres) Capacity (Ac-ft) 0.01	Area (acres) Capacity (Ac-ft) 0.02	Area (acres) Capacity (Ac-ft) 0.03	Area (acres) Capacity (Ac-ft) 0.04	Area (acres) Capacity (Ac-ft) 0.05	Area (acres) Capacity (Ac-ft) 0.06	Area (acres) Capacity (Ac-ft) 0.07	Area (acres) Capacity (Ac-ft) 0.08	Area (acres) Capacity (Ac-ft) 0.09
92	5601 25666	5607 25722	5612 25778	5618 25834	5623 25890	5628 25947	5634 26003	5639 26059	5645 26116	5650 26172
92.1	5656 26229	5661 26285	5667 26342	5672 26399	5678 26456	5683 26512	5689 26569	5694 26626	5700 26683	5705 26740
92.2	5711 26797	5716 26854	5722 26911	5727 26969	5733 27026	5738 27083	5744 27141	5749 27198	5755 27256	5761 27313
92.3	5766 27371	5772 27429	5777 27486	5783 27544	5788 27602	5794 27660	5799 27718	5805 27776	5810 27834	5816 27892
92.4	5822 27950	5827 28009	5833 28067	5838 28125	5844 28184	5849 28242	5855 28301	5861 28359	5866 28418	5872 28477
92.5	5877 28535	5883 28594	5889 28653	5894 28712	5900 28771	5905 28830	5911 28889	5917 28948	5922 29007	5928 29067
92.6	5933 29126	5939 29185	5945 29245	5950 29304	5956 29364	5961 29423	5967 29483	5973 29543	5978 29602	5984 29662
92.7	5990 29722	5995 29782	6001 29842	6007 29902	6012 29962	6018 30022	6024 30082	6029 30143	6035 30203	6041 30263
92.8	6046 30324	6052 30384	6058 30445	6063 30505	6069 30566	6075 30627	6080 30688	6086 30748	6092 30809	6097 30870
92.9	6103 30931	6109 30992	6114 31053	6120 31115	6126 31176	6132 31237	6137 31298	6143 31360	6149 31421	6154 31483
93	6160 31544	6166 31606	6171 31668	6177 31729	6183 31791	6188 31853	6194 31915	6199 31977	6205 32039	6211 32101
93.1	6216 32163	6222 32225	6228 32288	6233 32350	6239 32412	6245 32475	6250 32537	6256 32600	6261 32662	6267 32725
93.2	6273 32788	6278 32850	6284 32913	6290 32976	6295 33039	6301 33102	6307 33165	6312 33228	6318 33291	6324 33355
93.3	6329 33418	6335 33481	6341 33545	6346 33608	6352 33671	6358 33735	6364 33799	6369 33862	6375 33926	6381 33990
93.4	6386 34054	6392 34118	6398 34181	6403 34245	6409 34310	6415 34374	6421 34438	6426 34502	6432 34566	6438 34631
93.5	6444 34695	6449 34760	6455 34824	6461 34889	6466 34953	6472 35018	6478 35083	6484 35148	6489 35212	6495 35277
93.6	6501 35342	6507 35407	6512 35472	6518 35538	6524 35603	6530 35668	6536 35733	6541 35799	6547 35864	6553 35930
93.7	6559 35995	6564 36061	6570 36127	6576 36192	6582 36258	6588 36324	6593 36390	6599 36456	6605 36522	6611 36588
93.8	6617 36654	6622 36720	6628 36787	6634 36853	6640 36919	6646 36986	6651 37052	6657 37119	6663 37185	6669 37252
93.9	6675 37319	6681 37385	6686 37452	6692 37519	6698 37586	6704 37653	6710 37720	6716 37787	6722 37854	6727 37922

Table 7-01

Elevation-Area/Capacity Table - Addicks Reservoir

Elevation (ft) NAVD 1988	Area (acres) Capacity (Ac-ft) 0	Area (acres) Capacity (Ac-ft) 0.01	Area (acres) Capacity (Ac-ft) 0.02	Area (acres) Capacity (Ac-ft) 0.03	Area (acres) Capacity (Ac-ft) 0.04	Area (acres) Capacity (Ac-ft) 0.05	Area (acres) Capacity (Ac-ft) 0.06	Area (acres) Capacity (Ac-ft) 0.07	Area (acres) Capacity (Ac-ft) 0.08	Area (acres) Capacity (Ac-ft) 0.09
94	6733 37989	6739 38056	6745 38124	6750 38191	6756 38259	6762 38326	6767 38394	6773 38462	6779 38530	6784 38597
94.1	6790 38665	6796 38733	6801 38801	6807 38869	6813 38937	6819 39005	6824 39074	6830 39142	6836 39210	6841 39279
94.2	6847 39347	6853 39416	6859 39484	6864 39553	6870 39621	6876 39690	6882 39759	6887 39828	6893 39897	6899 39966
94.3	6904 40035	6910 40104	6916 40173	6922 40242	6927 40311	6933 40381	6939 40450	6945 40519	6951 40589	6956 40658
94.4	6962 40728	6968 40798	6974 40867	6979 40937	6985 41007	6991 41077	6997 41147	7002 41217	7008 41287	7014 41357
94.5	7020 41427	7026 41497	7031 41568	7037 41638	7043 41708	7049 41779	7055 41849	7060 41920	7066 41991	7072 42061
94.6	7078 42132	7084 42203	7090 42274	7095 42345	7101 42416	7107 42487	7113 42558	7119 42629	7125 42700	7130 42771
94.7	7136 42843	7142 42914	7148 42985	7154 43057	7160 43129	7165 43200	7171 43272	7177 43344	7183 43415	7189 43487
94.8	7195 43559	7201 43631	7206 43703	7212 43775	7218 43847	7224 43920	7230 43992	7236 44064	7242 44137	7248 44209
94.9	7253 44282	7259 44354	7265 44427	7271 44499	7277 44572	7283 44645	7289 44718	7295 44791	7301 44864	7307 44937
95	7312 45010	7319 45083	7326 45156	7333 45230	7340 45303	7347 45376	7354 45450	7361 45523	7368 45597	7375 45671
95.1	7382 45745	7389 45818	7396 45892	7403 45966	7410 46040	7417 46115	7425 46189	7432 46263	7439 46337	7446 46412
95.2	7453 46486	7460 46561	7467 46636	7474 46710	7481 46785	7488 46860	7495 46935	7502 47010	7509 47085	7516 47160
95.3	7523 47235	7530 47310	7537 47386	7544 47461	7552 47537	7559 47612	7566 47688	7573 47764	7580 47839	7587 47915
95.4	7594 47991	7601 48067	7608 48143	7616 48219	7623 48295	7630 48372	7637 48448	7644 48524	7651 48601	7658 48677
95.5	7665 48754	7673 48831	7680 48907	7687 48984	7694 49061	7701 49138	7708 49215	7716 49292	7723 49370	7730 49447
95.6	7737 49524	7744 49602	7751 49679	7759 49757	7766 49834	7773 49912	7780 49990	7787 50067	7795 50145	7802 50223
95.7	7809 50301	7816 50380	7823 50458	7831 50536	7838 50614	7845 50693	7852 50771	7859 50850	7867 50928	7874 51007
95.8	7881 51086	7888 51165	7896 51244	7903 51323	7910 51402	7917 51481	7925 51560	7932 51639	7939 51719	7947 51798
95.9	7954 51878	7961 51957	7968 52037	7976 52117	7983 52196	7990 52276	7998 52356	8005 52436	8012 52516	8019 52596

Table 7-01

Elevation-Area/Capacity Table - Addicks Reservoir

Elevation (ft) NAVD 1988	Area (acres) Capacity (Ac-ft) 0	Area (acres) Capacity (Ac-ft) 0.01	Area (acres) Capacity (Ac-ft) 0.02	Area (acres) Capacity (Ac-ft) 0.03	Area (acres) Capacity (Ac-ft) 0.04	Area (acres) Capacity (Ac-ft) 0.05	Area (acres) Capacity (Ac-ft) 0.06	Area (acres) Capacity (Ac-ft) 0.07	Area (acres) Capacity (Ac-ft) 0.08	Area (acres) Capacity (Ac-ft) 0.09
96	8027 52677	8035 52757	8043 52837	8051 52918	8059 52998	8067 53079	8075 53160	8083 53241	8092 53321	8100 53402
96.1	8108 53483	8116 53565	8124 53646	8132 53727	8140 53808	8148 53890	8157 53971	8165 54053	8173 54135	8181 54216
96.2	8189 54298	8197 54380	8206 54462	8214 54544	8222 54627	8230 54709	8238 54791	8246 54874	8255 54956	8263 55039
96.3	8271 55121	8279 55204	8287 55287	8296 55370	8304 55453	8312 55536	8320 55619	8329 55702	8337 55786	8345 55869
96.4	8353 55953	8362 56036	8370 56120	8378 56203	8386 56287	8395 56371	8403 56455	8411 56539	8419 56623	8428 56708
96.5	8436 56792	8444 56876	8453 56961	8461 57045	8469 57130	8477 57215	8486 57300	8494 57385	8502 57470	8511 57555
96.6	8519 57640	8527 57725	8536 57810	8544 57896	8552 57981	8561 58067	8569 58152	8577 58238	8586 58324	8594 58410
96.7	8603 58496	8611 58582	8619 58668	8628 58754	8636 58841	8644 58927	8653 59013	8661 59100	8670 59187	8678 59273
96.8	8686 59360	8695 59447	8703 59534	8712 59621	8720 59708	8729 59796	8737 59883	8745 59970	8754 60058	8762 60145
96.9	8771 60233	8779 60321	8788 60409	8796 60497	8805 60585	8813 60673	8821 60761	8830 60849	8838 60937	8847 61026
97	8855 61114	8863 61203	8870 61292	8877 61380	8884 61469	8891 61558	8899 61647	8906 61736	8913 61825	8920 61914
97.1	8927 62004	8935 62093	8942 62182	8949 62272	8956 62361	8964 62451	8971 62540	8978 62630	8985 62720	8992 62810
97.2	9000 62900	9007 62990	9014 63080	9021 63170	9029 63260	9036 63351	9043 63441	9050 63532	9058 63622	9065 63713
97.3	9072 63803	9080 63894	9087 63985	9094 64076	9101 64167	9109 64258	9116 64349	9123 64440	9130 64532	9138 64623
97.4	9145 64714	9152 64806	9160 64897	9167 64989	9174 65081	9182 65173	9189 65264	9196 65356	9204 65448	9211 65540
97.5	9218 65633	9226 65725	9233 65817	9240 65909	9248 66002	9255 66094	9262 66187	9270 66280	9277 66372	9284 66465
97.6	9292 66558	9299 66651	9306 66744	9314 66837	9321 66930	9328 67024	9336 67117	9343 67210	9351 67304	9358 67397
97.7	9365 67491	9373 67585	9380 67678	9388 67772	9395 67866	9402 67960	9410 68054	9417 68148	9425 68242	9432 68337
97.8	9439 68431	9447 68526	9454 68620	9462 68715	9469 68809	9477 68904	9484 68999	9491 69094	9499 69189	9506 69284
97.9	9514 69379	9521 69474	9529 69569	9536 69664	9544 69760	9551 69855	9558 69951	9566 70047	9573 70142	9581 70238

Table 7-01

Elevation-Area/Capacity Table - Addicks Reservoir

Elevation (ft) NAVD 1988	Area (acres) Capacity (Ac-ft) 0	Area (acres) Capacity (Ac-ft) 0.01	Area (acres) Capacity (Ac-ft) 0.02	Area (acres) Capacity (Ac-ft) 0.03	Area (acres) Capacity (Ac-ft) 0.04	Area (acres) Capacity (Ac-ft) 0.05	Area (acres) Capacity (Ac-ft) 0.06	Area (acres) Capacity (Ac-ft) 0.07	Area (acres) Capacity (Ac-ft) 0.08	Area (acres) Capacity (Ac-ft) 0.09
98	9588 70334	9596 70430	9604 70526	9612 70622	9620 70718	9628 70814	9636 70911	9643 71007	9651 71103	9659 71200
98.1	9667 71297	9675 71393	9683 71490	9691 71587	9699 71684	9707 71781	9715 71878	9723 71975	9731 72073	9738 72170
98.2	9746 72267	9754 72365	9762 72462	9770 72560	9778 72658	9786 72756	9794 72854	9802 72951	9810 73050	9818 73148
98.3	9826 73246	9834 73344	9842 73443	9850 73541	9858 73640	9866 73738	9874 73837	9882 73936	9890 74035	9898 74133
98.4	9906 74232	9914 74332	9922 74431	9930 74530	9938 74629	9946 74729	9954 74828	9962 74928	9970 75028	9978 75127
98.5	9986 75227	9994 75327	10002 75427	10010 75527	10018 75627	10026 75727	10034 75828	10042 75928	10050 76029	10058 76129
98.6	10067 76230	10075 76330	10083 76431	10091 76532	10099 76633	10107 76734	10115 76835	10123 76936	10131 77038	10139 77139
98.7	10147 77240	10155 77342	10164 77444	10172 77545	10180 77647	10188 77749	10196 77851	10204 77953	10212 78055	10220 78157
98.8	10229 78259	10237 78362	10245 78464	10253 78566	10261 78669	10269 78772	10277 78874	10286 78977	10294 79080	10302 79183
98.9	10310 79286	10318 79389	10326 79492	10334 79596	10343 79699	10351 79803	10359 79906	10367 80010	10375 80114	10384 80217
99	10392 80321	10400 80425	10408 80529	10415 80633	10423 80737	10431 80842	10439 80946	10447 81051	10455 81155	10463 81260
99.1	10471 81364	10479 81469	10486 81574	10494 81679	10502 81784	10510 81889	10518 81994	10526 82099	10534 82204	10542 82310
99.2	10550 82415	10558 82521	10566 82626	10574 82732	10582 82838	10589 82944	10597 83050	10605 83156	10613 83262	10621 83368
99.3	10629 83474	10637 83581	10645 83687	10653 83794	10661 83900	10669 84007	10677 84113	10685 84220	10693 84327	10701 84434
99.4	10709 84541	10717 84648	10725 84756	10733 84863	10741 84970	10749 85078	10757 85185	10765 85293	10773 85400	10781 85508
99.5	10789 85616	10797 85724	10805 85832	10813 85940	10821 86048	10829 86157	10837 86265	10845 86373	10853 86482	10861 86590
99.6	10869 86699	10877 86808	10885 86917	10894 87025	10902 87134	10910 87243	10918 87353	10926 87462	10934 87571	10942 87681
99.7	10950 87790	10958 87900	10966 88009	10974 88119	10982 88229	10990 88338	10999 88448	11007 88558	11015 88669	11023 88779
99.8	11031 88889	11039 88999	11047 89110	11055 89220	11063 89331	11072 89442	11080 89552	11088 89663	11096 89774	11104 89885
99.9	11112 89996	11120 90107	11128 90219	11137 90330	11145 90441	11153 90553	11161 90664	11169 90776	11177 90888	11186 91000

Table 7-01

Elevation-Area/Capacity Table - Addicks Reservoir

Elevation (ft) NAVD 1988	Area (acres) Capacity (Ac-ft) 0	Area (acres) Capacity (Ac-ft) 0.01	Area (acres) Capacity (Ac-ft) 0.02	Area (acres) Capacity (Ac-ft) 0.03	Area (acres) Capacity (Ac-ft) 0.04	Area (acres) Capacity (Ac-ft) 0.05	Area (acres) Capacity (Ac-ft) 0.06	Area (acres) Capacity (Ac-ft) 0.07	Area (acres) Capacity (Ac-ft) 0.08	Area (acres) Capacity (Ac-ft) 0.09
100	11194 91111	11200 91223	11207 91335	11214 91448	11221 91560	11228 91672	11234 91784	11241 91897	11248 92009	11255 92122
100.1	11261 92234	11268 92347	11275 92460	11282 92572	11288 92685	11295 92798	11302 92911	11309 93024	11316 93137	11322 93250
100.2	11329 93364	11336 93477	11343 93590	11350 93704	11356 93817	11363 93931	11370 94045	11377 94158	11384 94272	11390 94386
100.3	11397 94500	11404 94614	11411 94728	11418 94842	11425 94957	11431 95071	11438 95185	11445 95300	11452 95414	11459 95529
100.4	11466 95643	11472 95758	11479 95873	11486 95987	11493 96102	11500 96217	11507 96332	11513 96447	11520 96563	11527 96678
100.5	11534 96793	11541 96909	11548 97024	11555 97140	11561 97255	11568 97371	11575 97486	11582 97602	11589 97718	11596 97834
100.6	11603 97950	11609 98066	11616 98182	11623 98298	11630 98415	11637 98531	11644 98647	11651 98764	11658 98880	11665 98997
100.7	11671 99114	11678 99230	11685 99347	11692 99464	11699 99581	11706 99698	11713 99815	11720 99932	11727 100050	11734 100167
100.8	11741 100284	11747 100402	11754 100519	11761 100637	11768 100754	11775 100872	11782 100990	11789 101108	11796 101226	11803 101344
100.9	11810 101462	11817 101580	11824 101698	11831 101816	11838 101935	11845 102053	11851 102172	11858 102290	11865 102409	11872 102528
101	11879 102646	11885 102765	11892 102884	11898 103003	11904 103122	11910 103241	11916 103360	11922 103479	11928 103599	11934 103718
101.1	11941 103837	11947 103957	11953 104076	11959 104196	11965 104315	11971 104435	11977 104555	11983 104675	11990 104794	11996 104914
101.2	12002 105034	12008 105154	12014 105275	12020 105395	12027 105515	12033 105635	12039 105756	12045 105876	12051 105997	12057 106117
101.3	12063 106238	12070 106358	12076 106479	12082 106600	12088 106721	12094 106842	12101 106963	12107 107084	12113 107205	12119 107326
101.4	12125 107447	12131 107568	12138 107690	12144 107811	12150 107933	12156 108054	12162 108176	12169 108297	12175 108419	12181 108541
101.5	12187 108663	12193 108785	12199 108907	12206 109029	12212 109151	12218 109273	12224 109395	12231 109517	12237 109640	12243 109762
101.6	12249 109885	12255 110007	12262 110130	12268 110252	12274 110375	12280 110498	12286 110621	12293 110743	12299 110866	12305 110989
101.7	12311 111113	12318 111236	12324 111359	12330 111482	12336 111605	12342 111729	12349 111852	12355 111976	12361 112099	12367 112223
101.8	12374 112347	12380 112471	12386 112594	12392 112718	12399 112842	12405 112966	12411 113090	12417 113214	12424 113339	12430 113463
101.9	12436 113587	12442 113712	12449 113836	12455 113961	12461 114085	12468 114210	12474 114335	12480 114459	12486 114584	12493 114709

Table 7-01

Elevation-Area/Capacity Table - Addicks Reservoir

Elevation (ft) NAVD 1988	Area (acres) Capacity (Ac-ft) 0	Area (acres) Capacity (Ac-ft) 0.01	Area (acres) Capacity (Ac-ft) 0.02	Area (acres) Capacity (Ac-ft) 0.03	Area (acres) Capacity (Ac-ft) 0.04	Area (acres) Capacity (Ac-ft) 0.05	Area (acres) Capacity (Ac-ft) 0.06	Area (acres) Capacity (Ac-ft) 0.07	Area (acres) Capacity (Ac-ft) 0.08	Area (acres) Capacity (Ac-ft) 0.09
102	12499 114834	12504 114959	12509 115084	12514 115209	12519 115334	12524 115460	12530 115585	12535 115710	12540 115836	12545 115961
102.1	12550 116086	12555 116212	12560 116338	12565 116463	12571 116589	12576 116715	12581 116840	12586 116966	12591 117092	12596 117218
102.2	12601 117344	12607 117470	12612 117596	12617 117722	12622 117849	12627 117975	12632 118101	12637 118227	12643 118354	12648 118480
102.3	12653 118607	12658 118733	12663 118860	12668 118987	12674 119113	12679 119240	12684 119367	12689 119494	12694 119621	12699 119748
102.4	12704 119875	12710 120002	12715 120129	12720 120256	12725 120383	12730 120511	12735 120638	12741 120765	12746 120893	12751 121020
102.5	12756 121148	12761 121275	12766 121403	12772 121531	12777 121658	12782 121786	12787 121914	12792 122042	12798 122170	12803 122298
102.6	12808 122426	12813 122554	12818 122682	12823 122810	12829 122939	12834 123067	12839 123195	12844 123324	12849 123452	12855 123581
102.7	12860 123709	12865 123838	12870 123967	12875 124095	12881 124224	12886 124353	12891 124482	12896 124611	12901 124740	12907 124869
102.8	12912 124998	12917 125127	12922 125256	12927 125385	12933 125515	12938 125644	12943 125773	12948 125903	12953 126032	12959 126162
102.9	12964 126292	12969 126421	12974 126551	12979 126681	12985 126811	12990 126940	12995 127070	13000 127200	13006 127330	13011 127460
103	13016 127591	13021 127721	13025 127851	13030 127981	13034 128112	13039 128242	13044 128372	13048 128503	13053 128633	13057 128764
103.1	13062 128895	13067 129025	13071 129156	13076 129287	13080 129417	13085 129548	13090 129679	13094 129810	13099 129941	13104 130072
103.2	13108 130203	13113 130334	13117 130465	13122 130596	13127 130728	13131 130859	13136 130990	13141 131122	13145 131253	13150 131385
103.3	13154 131516	13159 131648	13164 131779	13168 131911	13173 132043	13178 132174	13182 132306	13187 132438	13191 132570	13196 132702
103.4	13201 132834	13205 132966	13210 133098	13215 133230	13219 133362	13224 133495	13228 133627	13233 133759	13238 133891	13242 134024
103.5	13247 134156	13252 134289	13256 134421	13261 134554	13266 134687	13270 134819	13275 134952	13280 135085	13284 135218	13289 135350
103.6	13293 135483	13298 135616	13303 135749	13307 135882	13312 136015	13317 136149	13321 136282	13326 136415	13331 136548	13335 136682
103.7	13340 136815	13345 136948	13349 137082	13354 137215	13359 137349	13363 137483	13368 137616	13373 137750	13377 137884	13382 138017
103.8	13387 138151	13391 138285	13396 138419	13401 138553	13405 138687	13410 138821	13415 138955	13419 139090	13424 139224	13429 139358
103.9	13433 139492	13438 139627	13443 139761	13447 139895	13452 140030	13457 140165	13461 140299	13466 140434	13471 140568	13475 140703

Table 7-01

Elevation-Area/Capacity Table - Addicks Reservoir

Elevation (ft) NAVD 1988	Area (acres) Capacity (Ac-ft) 0	Area (acres) Capacity (Ac-ft) 0.01	Area (acres) Capacity (Ac-ft) 0.02	Area (acres) Capacity (Ac-ft) 0.03	Area (acres) Capacity (Ac-ft) 0.04	Area (acres) Capacity (Ac-ft) 0.05	Area (acres) Capacity (Ac-ft) 0.06	Area (acres) Capacity (Ac-ft) 0.07	Area (acres) Capacity (Ac-ft) 0.08	Area (acres) Capacity (Ac-ft) 0.09
104	13480 140838	13486 140973	13491 141108	13496 141243	13502 141378	13507 141513	13513 141648	13518 141783	13524 141918	13529 142053
104.1	13535 142189	13540 142324	13546 142460	13551 142595	13557 142731	13562 142866	13568 143002	13573 143137	13579 143273	13584 143409
104.2	13590 143545	13595 143681	13601 143817	13606 143953	13612 144089	13617 144225	13623 144361	13628 144498	13634 144634	13639 144770
104.3	13645 144907	13650 145043	13656 145180	13661 145316	13667 145453	13672 145590	13678 145726	13683 145863	13689 146000	13694 146137
104.4	13700 146274	13705 146411	13711 146548	13716 146685	13722 146822	13727 146960	13733 147097	13738 147234	13744 147372	13750 147509
104.5	13755 147647	13761 147784	13766 147922	13772 148060	13777 148197	13783 148335	13788 148473	13794 148611	13799 148749	13805 148887
104.6	13810 149025	13816 149163	13822 149301	13827 149439	13833 149578	13838 149716	13844 149855	13849 149993	13855 150131	13860 150270
104.7	13866 150409	13871 150547	13877 150686	13883 150825	13888 150964	13894 151103	13899 151242	13905 151381	13910 151520	13916 151659
104.8	13921 151798	13927 151937	13933 152077	13938 152216	13944 152355	13949 152495	13955 152634	13960 152774	13966 152914	13972 153053
104.9	13977 153193	13983 153333	13988 153473	13994 153613	13999 153753	14005 153893	14011 154033	14016 154173	14022 154313	14027 154453
105	14033 154593	14039 154734	14044 154874	14050 155015	14055 155155	14061 155296	14067 155436	14072 155577	14078 155718	14084 155859
105.1	14089 156000	14095 156141	14101 156282	14106 156423	14112 156564	14118 156705	14123 156846	14129 156987	14135 157129	14140 157270
105.2	14146 157411	14152 157553	14157 157694	14163 157836	14169 157978	14174 158119	14180 158261	14186 158403	14191 158545	14197 158687
105.3	14203 158829	14208 158971	14214 159113	14220 159255	14225 159397	14231 159540	14237 159682	14242 159824	14248 159967	14254 160109
105.4	14259 160252	14265 160395	14271 160537	14276 160680	14282 160823	14288 160966	14293 161108	14299 161251	14305 161394	14311 161538
105.5	14316 161681	14322 161824	14328 161967	14333 162110	14339 162254	14345 162397	14350 162541	14356 162684	14362 162828	14368 162971
105.6	14373 163115	14379 163259	14385 163403	14390 163547	14396 163691	14402 163835	14408 163979	14413 164123	14419 164267	14425 164411
105.7	14430 164555	14436 164700	14442 164844	14448 164988	14453 165133	14459 165278	14465 165422	14470 165567	14476 165712	14482 165856
105.8	14488 166001	14493 166146	14499 166291	14505 166436	14511 166581	14516 166726	14522 166872	14528 167017	14533 167162	14539 167307
105.9	14545 167453	14551 167598	14556 167744	14562 167889	14568 168035	14574 168181	14579 168327	14585 168472	14591 168618	14597 168764

Table 7-01

Elevation-Area/Capacity Table - Addicks Reservoir

Elevation (ft) NAVD 1988	Area (acres) Capacity (Ac-ft) 0	Area (acres) Capacity (Ac-ft) 0.01	Area (acres) Capacity (Ac-ft) 0.02	Area (acres) Capacity (Ac-ft) 0.03	Area (acres) Capacity (Ac-ft) 0.04	Area (acres) Capacity (Ac-ft) 0.05	Area (acres) Capacity (Ac-ft) 0.06	Area (acres) Capacity (Ac-ft) 0.07	Area (acres) Capacity (Ac-ft) 0.08	Area (acres) Capacity (Ac-ft) 0.09
106	14602 168910	14610 169056	14617 169202	14624 169349	14631 169495	14639 169641	14646 169788	14653 169934	14660 170081	14668 170227
106.1	14675 170374	14682 170521	14689 170668	14697 170815	14704 170962	14711 171109	14718 171256	14726 171403	14733 171550	14740 171698
106.2	14748 171845	14755 171993	14762 172140	14769 172288	14777 172436	14784 172583	14791 172731	14799 172879	14806 173027	14813 173175
106.3	14820 173324	14828 173472	14835 173620	14842 173769	14850 173917	14857 174066	14864 174214	14872 174363	14879 174512	14886 174660
106.4	14893 174809	14901 174958	14908 175107	14915 175256	14923 175406	14930 175555	14937 175704	14945 175854	14952 176003	14959 176153
106.5	14967 176302	14974 176452	14981 176602	14989 176752	14996 176902	15003 177052	15011 177202	15018 177352	15025 177502	15033 177652
106.6	15040 177803	15047 177953	15055 178104	15062 178254	15069 178405	15077 178556	15084 178706	15091 178857	15099 179008	15106 179159
106.7	15114 179310	15121 179461	15128 179613	15136 179764	15143 179915	15150 180067	15158 180218	15165 180370	15173 180522	15180 180674
106.8	15187 180825	15195 180977	15202 181129	15209 181281	15217 181433	15224 181586	15232 181738	15239 181890	15246 182043	15254 182195
106.9	15261 182348	15269 182500	15276 182653	15283 182806	15291 182959	15298 183112	15306 183265	15313 183418	15320 183571	15328 183724
107	15335 183878	15344 184031	15352 184184	15361 184338	15369 184492	15378 184645	15386 184799	15395 184953	15404 185107	15412 185261
107.1	15421 185415	15429 185570	15438 185724	15446 185878	15455 186033	15463 186187	15472 186342	15480 186497	15489 186652	15498 186807
107.2	15506 186962	15515 187117	15523 187272	15532 187427	15540 187583	15549 187738	15558 187894	15566 188049	15575 188205	15583 188361
107.3	15592 188517	15601 188673	15609 188829	15618 188985	15626 189141	15635 189297	15643 189454	15652 189610	15661 189767	15669 189923
107.4	15678 190080	15687 190237	15695 190394	15704 190551	15712 190708	15721 190865	15730 191022	15738 191180	15747 191337	15756 191495
107.5	15764 191652	15773 191810	15781 191968	15790 192126	15799 192283	15807 192442	15816 192600	15825 192758	15833 192916	15842 193075
107.6	15851 193233	15859 193392	15868 193550	15877 193709	15885 193868	15894 194027	15903 194186	15911 194345	15920 194504	15929 194663
107.7	15937 194822	15946 194982	15955 195141	15963 195301	15972 195461	15981 195620	15990 195780	15998 195940	16007 196100	16016 196260
107.8	16024 196420	16033 196581	16042 196741	16050 196902	16059 197062	16068 197223	16077 197383	16085 197544	16094 197705	16103 197866
107.9	16112 198027	16120 198188	16129 198350	16138 198511	16146 198672	16155 198834	16164 198995	16173 199157	16181 199319	16190 199481

Table 7-01

Elevation-Area/Capacity Table - Addicks Reservoir

Elevation (ft) NAVD 1988	Area (acres) Capacity (Ac-ft) 0	Area (acres) Capacity (Ac-ft) 0.01	Area (acres) Capacity (Ac-ft) 0.02	Area (acres) Capacity (Ac-ft) 0.03	Area (acres) Capacity (Ac-ft) 0.04	Area (acres) Capacity (Ac-ft) 0.05	Area (acres) Capacity (Ac-ft) 0.06	Area (acres) Capacity (Ac-ft) 0.07	Area (acres) Capacity (Ac-ft) 0.08	Area (acres) Capacity (Ac-ft) 0.09
108	16199 199643	16206 199805	16213 199967	16220 200129	16227 200291	16235 200454	16242 200616	16249 200778	16256 200941	16263 201104
108.1	16270 201266	16277 201429	16285 201592	16292 201755	16299 201918	16306 202081	16313 202244	16320 202407	16327 202570	16335 202733
108.2	16342 202897	16349 203060	16356 203224	16363 203387	16370 203551	16377 203715	16385 203879	16392 204042	16399 204206	16406 204370
108.3	16413 204535	16420 204699	16428 204863	16435 205027	16442 205192	16449 205356	16456 205521	16464 205685	16471 205850	16478 206015
108.4	16485 206179	16492 206344	16499 206509	16507 206674	16514 206839	16521 207005	16528 207170	16535 207335	16543 207501	16550 207666
108.5	16557 207832	16564 207997	16571 208163	16579 208329	16586 208494	16593 208660	16600 208826	16607 208992	16615 209158	16622 209325
108.6	16629 209491	16636 209657	16644 209824	16651 209990	16658 210157	16665 210323	16672 210490	16680 210657	16687 210824	16694 210990
108.7	16701 211157	16709 211324	16716 211492	16723 211659	16730 211826	16738 211993	16745 212161	16752 212328	16759 212496	16766 212663
108.8	16774 212831	16781 212999	16788 213167	16795 213335	16803 213503	16810 213671	16817 213839	16825 214007	16832 214175	16839 214344
108.9	16846 214512	16854 214681	16861 214849	16868 215018	16875 215187	16883 215355	16890 215524	16897 215693	16904 215862	16912 216031
109	16919 216200	16926 216370	16933 216539	16940 216708	16947 216878	16954 217047	16961 217217	16968 217386	16975 217556	16982 217726
109.1	16989 217896	16996 218066	17003 218236	17010 218406	17017 218576	17024 218746	17031 218916	17038 219087	17045 219257	17052 219428
109.2	17059 219598	17066 219769	17073 219940	17080 220110	17087 220281	17094 220452	17101 220623	17108 220794	17115 220965	17123 221136
109.3	17130 221308	17137 221479	17144 221650	17151 221822	17158 221993	17165 222165	17172 222337	17179 222508	17186 222680	17193 222852
109.4	17200 223024	17207 223196	17214 223368	17221 223540	17228 223713	17235 223885	17242 224057	17249 224230	17257 224402	17264 224575
109.5	17271 224748	17278 224920	17285 225093	17292 225266	17299 225439	17306 225612	17313 225785	17320 225958	17327 226132	17334 226305
109.6	17341 226478	17348 226652	17356 226825	17363 226999	17370 227173	17377 227346	17384 227520	17391 227694	17398 227868	17405 228042
109.7	17412 228216	17419 228390	17427 228564	17434 228739	17441 228913	17448 229087	17455 229262	17462 229437	17469 229611	17476 229786
109.8	17483 229961	17490 230136	17498 230311	17505 230486	17512 230661	17519 230836	17526 231011	17533 231186	17540 231362	17547 231537
109.9	17555 231713	17562 231888	17569 232064	17576 232240	17583 232415	17590 232591	17597 232767	17604 232943	17612 233119	17619 233295

Table 7-01

Elevation-Area/Capacity Table - Addicks Reservoir

Elevation (ft) NAVD 1988	Area (acres) Capacity (Ac-ft) 0	Area (acres) Capacity (Ac-ft) 0.01	Area (acres) Capacity (Ac-ft) 0.02	Area (acres) Capacity (Ac-ft) 0.03	Area (acres) Capacity (Ac-ft) 0.04	Area (acres) Capacity (Ac-ft) 0.05	Area (acres) Capacity (Ac-ft) 0.06	Area (acres) Capacity (Ac-ft) 0.07	Area (acres) Capacity (Ac-ft) 0.08	Area (acres) Capacity (Ac-ft) 0.09
110	17626 233472	17632 233648	17639 233824	17646 234001	17652 234177	17659 234354	17665 234530	17672 234707	17679 234884	17685 235061
110.1	17692 235238	17699 235415	17705 235592	17712 235769	17718 235946	17725 236123	17732 236300	17738 236478	17745 236655	17751 236833
110.2	17758 237010	17765 237188	17771 237365	17778 237543	17785 237721	17791 237899	17798 238077	17804 238255	17811 238433	17818 238611
110.3	17824 238789	17831 238967	17838 239146	17844 239324	17851 239503	17858 239681	17864 239860	17871 240039	17877 240217	17884 240396
110.4	17891 240575	17897 240754	17904 240933	17911 241112	17917 241291	17924 241470	17931 241650	17937 241829	17944 242008	17951 242188
110.5	17957 242367	17964 242547	17971 242727	17977 242906	17984 243086	17991 243266	17997 243446	18004 243626	18011 243806	18017 243986
110.6	18024 244166	18031 244347	18037 244527	18044 244707	18051 244888	18057 245068	18064 245249	18071 245430	18077 245610	18084 245791
110.7	18091 245972	18097 246153	18104 246334	18111 246515	18117 246696	18124 246877	18131 247059	18137 247240	18144 247421	18151 247603
110.8	18158 247785	18164 247966	18171 248148	18178 248330	18184 248511	18191 248693	18198 248875	18204 249057	18211 249239	18218 249421
110.9	18225 249604	18231 249786	18238 249968	18245 250151	18251 250333	18258 250516	18265 250698	18271 250881	18278 251064	18285 251247
111	18292 251429	18297 251612	18303 251795	18309 251978	18314 252162	18320 252345	18325 252528	18331 252711	18337 252895	18342 253078
111.1	18348 253261	18353 253445	18359 253628	18365 253812	18370 253996	18376 254179	18382 254363	18387 254547	18393 254731	18399 254915
111.2	18404 255099	18410 255283	18415 255467	18421 255651	18427 255836	18432 256020	18438 256204	18444 256389	18449 256573	18455 256758
111.3	18461 256942	18466 257127	18472 257312	18477 257496	18483 257681	18489 257866	18494 258051	18500 258236	18506 258421	18511 258606
111.4	18517 258791	18523 258976	18528 259162	18534 259347	18540 259532	18545 259718	18551 259903	18557 260089	18562 260274	18568 260460
111.5	18574 260646	18579 260831	18585 261017	18591 261203	18596 261389	18602 261575	18608 261761	18613 261947	18619 262133	18625 262320
111.6	18630 262506	18636 262692	18642 262879	18647 263065	18653 263251	18659 263438	18664 263625	18670 263811	18676 263998	18681 264185
111.7	18687 264372	18693 264559	18698 264746	18704 264933	18710 265120	18715 265307	18721 265494	18727 265681	18732 265868	18738 266056
111.8	18744 266243	18749 266431	18755 266618	18761 266806	18767 266993	18772 267181	18778 267369	18784 267557	18789 267745	18795 267932
111.9	18801 268120	18806 268308	18812 268497	18818 268685	18823 268873	18829 269061	18835 269250	18841 269438	18846 269626	18852 269815

Table 7-01

Elevation-Area/Capacity Table - Addicks Reservoir

Elevation (ft) NAVD 1988	Area (acres) Capacity (Ac-ft) 0	Area (acres) Capacity (Ac-ft) 0.01	Area (acres) Capacity (Ac-ft) 0.02	Area (acres) Capacity (Ac-ft) 0.03	Area (acres) Capacity (Ac-ft) 0.04	Area (acres) Capacity (Ac-ft) 0.05	Area (acres) Capacity (Ac-ft) 0.06	Area (acres) Capacity (Ac-ft) 0.07	Area (acres) Capacity (Ac-ft) 0.08	Area (acres) Capacity (Ac-ft) 0.09
112	18858 270003	18864 270192	18871 270381	18877 270569	18884 270758	18890 270947	18897 271136	18903 271325	18910 271514	18916 271703
112.1	18923 271892	18929 272082	18936 272271	18942 272460	18949 272650	18956 272839	18962 273029	18969 273219	18975 273408	18982 273598
112.2	18988 273788	18995 273978	19001 274168	19008 274358	19014 274548	19021 274738	19027 274928	19034 275119	19040 275309	19047 275500
112.3	19054 275690	19060 275881	19067 276071	19073 276262	19080 276453	19086 276644	19093 276834	19099 277025	19106 277216	19113 277408
112.4	19119 277599	19126 277790	19132 277981	19139 278173	19145 278364	19152 278555	19158 278747	19165 278939	19172 279130	19178 279322
112.5	19185 279514	19191 279706	19198 279898	19204 280090	19211 280282	19218 280474	19224 280666	19231 280858	19237 281051	19244 281243
112.6	19250 281436	19257 281628	19264 281821	19270 282013	19277 282206	19283 282399	19290 282592	19297 282785	19303 282978	19310 283171
112.7	19316 283364	19323 283557	19329 283750	19336 283944	19343 284137	19349 284331	19356 284524	19362 284718	19369 284911	19376 285105
112.8	19382 285299	19389 285493	19395 285687	19402 285881	19409 286075	19415 286269	19422 286463	19429 286657	19435 286852	19442 287046
112.9	19448 287240	19455 287435	19462 287630	19468 287824	19475 288019	19481 288214	19488 288408	19495 288603	19501 288798	19508 288993
113	19515 289189	19522 289384	19530 289579	19537 289774	19545 289970	19552 290165	19560 290361	19567 290556	19575 290752	19583 290948
113.1	19590 291144	19598 291340	19605 291536	19613 291732	19620 291928	19628 292124	19636 292321	19643 292517	19651 292713	19658 292910
113.2	19666 293107	19673 293303	19681 293500	19689 293697	19696 293894	19704 294091	19711 294288	19719 294485	19727 294682	19734 294880
113.3	19742 295077	19749 295274	19757 295472	19765 295670	19772 295867	19780 296065	19787 296263	19795 296461	19803 296659	19810 296857
113.4	19818 297055	19825 297253	19833 297451	19841 297650	19848 297848	19856 298047	19864 298245	19871 298444	19879 298643	19886 298842
113.5	19894 299041	19902 299240	19909 299439	19917 299638	19925 299837	19932 300036	19940 300236	19948 300435	19955 300635	19963 300834
113.6	19970 301034	19978 301234	19986 301433	19993 301633	20001 301833	20009 302033	20016 302233	20024 302434	20032 302634	20039 302834
113.7	20047 303035	20055 303235	20062 303436	20070 303636	20078 303837	20085 304038	20093 304239	20101 304440	20108 304641	20116 304842
113.8	20124 305043	20131 305244	20139 305446	20147 305647	20154 305849	20162 306050	20170 306252	20177 306454	20185 306656	20193 306857
113.9	20200 307059	20208 307261	20216 307464	20223 307666	20231 307868	20239 308070	20246 308273	20254 308475	20262 308678	20270 308881

Table 7-01

Elevation-Area/Capacity Table - Addicks Reservoir

Elevation (ft) NAVD 1988	Area (acres) Capacity (Ac-ft) 0	Area (acres) Capacity (Ac-ft) 0.01	Area (acres) Capacity (Ac-ft) 0.02	Area (acres) Capacity (Ac-ft) 0.03	Area (acres) Capacity (Ac-ft) 0.04	Area (acres) Capacity (Ac-ft) 0.05	Area (acres) Capacity (Ac-ft) 0.06	Area (acres) Capacity (Ac-ft) 0.07	Area (acres) Capacity (Ac-ft) 0.08	Area (acres) Capacity (Ac-ft) 0.09
114	20277 309083	20284 309286	20290 309489	20296 309692	20302 309895	20309 310098	20315 310301	20321 310504	20328 310707	20334 310911
114.1	20340 311114	20346 311318	20353 311521	20359 311725	20365 311928	20372 312132	20378 312336	20384 312539	20390 312743	20397 312947
114.2	20403 313151	20409 313355	20416 313559	20422 313764	20428 313968	20435 314172	20441 314377	20447 314581	20453 314786	20460 314990
114.3	20466 315195	20472 315399	20479 315604	20485 315809	20491 316014	20498 316219	20504 316424	20510 316629	20517 316834	20523 317039
114.4	20529 317244	20536 317450	20542 317655	20548 317861	20555 318066	20561 318272	20567 318477	20573 318683	20580 318889	20586 319095
114.5	20592 319301	20599 319507	20605 319713	20611 319919	20618 320125	20624 320331	20630 320537	20637 320744	20643 320950	20649 321156
114.6	20656 321363	20662 321570	20668 321776	20675 321983	20681 322190	20687 322397	20694 322603	20700 322810	20707 323017	20713 323225
114.7	20719 323432	20726 323639	20732 323846	20738 324054	20745 324261	20751 324468	20757 324676	20764 324884	20770 325091	20776 325299
114.8	20783 325507	20789 325715	20795 325923	20802 326131	20808 326339	20815 326547	20821 326755	20827 326963	20834 327171	20840 327380
114.9	20846 327588	20853 327797	20859 328005	20865 328214	20872 328423	20878 328631	20885 328840	20891 329049	20897 329258	20904 329467
115	20910 329676	20917 329885	20924 330094	20931 330304	20938 330513	20944 330722	20951 330932	20958 331141	20965 331351	20972 331561
115.1	20979 331771	20986 331980	20992 332190	20999 332400	21006 332610	21013 332820	21020 333030	21027 333241	21034 333451	21041 333661
115.2	21047 333872	21054 334082	21061 334293	21068 334504	21075 334714	21082 334925	21089 335136	21096 335347	21103 335558	21109 335769
115.3	21116 335980	21123 336191	21130 336402	21137 336614	21144 336825	21151 337037	21158 337248	21165 337460	21171 337672	21178 337883
115.4	21185 338095	21192 338307	21199 338519	21206 338731	21213 338943	21220 339155	21227 339367	21234 339580	21241 339792	21247 340005
115.5	21254 340217	21261 340430	21268 340642	21275 340855	21282 341068	21289 341281	21296 341494	21303 341707	21310 341920	21317 342133
115.6	21324 342346	21330 342559	21337 342773	21344 342986	21351 343199	21358 343413	21365 343627	21372 343840	21379 344054	21386 344268
115.7	21393 344482	21400 344696	21407 344910	21414 345124	21421 345338	21428 345552	21434 345767	21441 345981	21448 346195	21455 346410
115.8	21462 346625	21469 346839	21476 347054	21483 347269	21490 347484	21497 347699	21504 347914	21511 348129	21518 348344	21525 348559
115.9	21532 348774	21539 348990	21546 349205	21553 349421	21560 349636	21567 349852	21574 350067	21581 350283	21587 350499	21594 350715

Table 7-02

Elevation-Area/Capacity Table - Barker Reservoir

Elevation (ft) NAVD 1988	Area (acres)		Area (acres)		Area (acres)		Area (acres)		Area (acres)		Area (acres)	
	Capacity (Ac-ft)	Capacity (Ac-ft)	Capacity (Ac-ft)	Capacity (Ac-ft)	Capacity (Ac-ft)	Capacity (Ac-ft)	Capacity (Ac-ft)	Capacity (Ac-ft)	Capacity (Ac-ft)	Capacity (Ac-ft)	Capacity (Ac-ft)	Capacity (Ac-ft)
	0	0.01	0.02	0.03	0.04	0.05	0.06	0.07	0.08	0.09		
72	4	4	4	4	4	4	4	4	4	4	4	4
	0	0	0	0	0	0	0	0	0	0	0	0
72.1	4	4	4	4	4	4	4	4	4	4	4	4
	0	0	0	0	1	1	1	1	1	1	1	1
72.2	4	4	4	4	4	4	4	4	4	4	4	4
	1	1	1	1	1	1	1	1	1	1	1	1
72.3	4	4	5	5	5	5	5	5	5	5	5	5
	1	1	1	1	1	1	1	1	2	2	2	2
72.4	5	5	5	5	5	5	5	5	5	5	5	5
	2	2	2	2	2	2	2	2	2	2	2	2
72.5	5	5	5	5	5	5	5	5	5	5	5	5
	2	2	2	2	2	2	2	2	3	3	3	3
72.6	5	5	5	5	5	5	5	5	5	5	5	6
	3	3	3	3	3	3	3	3	3	3	3	3
72.7	6	6	6	6	6	6	6	6	6	6	6	6
	3	3	3	3	3	3	4	4	4	4	4	4
72.8	6	6	6	6	6	6	6	6	6	6	6	6
	4	4	4	4	4	4	4	4	4	4	4	4
72.9	6	6	6	6	6	6	6	6	6	6	6	6
	4	4	5	5	5	5	5	5	5	5	5	5
73	6	7	7	7	7	7	7	7	7	7	7	7
	5	5	5	5	5	5	5	5	5	5	6	6
73.1	7	7	7	7	7	7	7	8	8	8	8	8
	6	6	6	6	6	6	6	6	6	6	6	6
73.2	8	8	8	8	8	8	8	8	8	8	8	9
	6	7	7	7	7	7	7	7	7	7	7	7
73.3	9	9	9	9	9	9	9	9	9	9	9	9
	7	7	7	8	8	8	8	8	8	8	8	8
73.4	9	9	10	10	10	10	10	10	10	10	10	10
	8	8	8	8	8	9	9	9	9	9	9	9
73.5	10	10	10	10	11	11	11	11	11	11	11	11
	9	9	9	9	10	10	10	10	10	10	10	10
73.6	11	11	11	11	11	12	12	12	12	12	12	12
	10	10	10	11	11	11	11	11	11	11	11	11
73.7	12	12	12	12	12	12	13	13	13	13	13	13
	11	11	12	12	12	12	12	12	12	12	12	12
73.8	13	13	13	13	13	13	13	13	14	14	14	14
	13	13	13	13	13	13	13	13	14	14	14	14
73.9	14	14	14	14	14	14	14	15	15	15	15	15
	14	14	14	14	15	15	15	15	15	15	15	15

Table 7-02

Elevation-Area/Capacity Table - Barker Reservoir

Elevation (ft) NAVD 1988	Area (acres)	Area (acres)	Area (acres)	Area (acres)	Area (acres)	Area (acres)	Area (acres)	Area (acres)	Area (acres)	Area (acres)	Area (acres)
	Capacity (Ac-ft)	Capacity (Ac-ft)	Capacity (Ac-ft)	Capacity (Ac-ft)	Capacity (Ac-ft)	Capacity (Ac-ft)	Capacity (Ac-ft)	Capacity (Ac-ft)	Capacity (Ac-ft)	Capacity (Ac-ft)	Capacity (Ac-ft)
	0	0.01	0.02	0.03	0.04	0.05	0.06	0.07	0.08	0.09	
74	15	15	15	15	15	15	16	16	16	16	
	15	16	16	16	16	16	16	16	17	17	
74.1	16	16	16	16	16	17	17	17	17	17	
	17	17	17	17	17	18	18	18	18	18	
74.2	17	17	17	17	18	18	18	18	18	18	
	19	19	19	19	19	19	20	20	20	20	
74.3	18	18	19	19	19	19	19	19	19	19	
	20	21	21	21	21	21	21	22	22	22	
74.4	20	20	20	20	20	20	20	20	21	21	
	22	22	23	23	23	23	23	24	24	24	
74.5	21	21	21	21	21	21	22	22	22	22	
	24	24	25	25	25	25	26	26	26	26	
74.6	22	22	22	22	23	23	23	23	23	23	
	26	27	27	27	27	28	28	28	28	28	
74.7	23	24	24	24	24	24	24	24	25	25	
	29	29	29	29	30	30	30	30	31	31	
74.8	25	25	25	25	25	26	26	26	26	26	
	31	31	32	32	32	32	33	33	33	33	
74.9	26	26	27	27	27	27	27	27	27	28	
	34	34	34	34	35	35	35	36	36	36	
75	28	28	28	28	28	28	28	28	29	29	
	36	37	37	37	37	38	38	38	39	39	
75.1	29	29	29	29	29	29	29	29	30	30	
	39	39	40	40	40	41	41	41	41	42	
75.2	30	30	30	30	30	30	30	30	31	31	
	42	42	43	43	43	44	44	44	45	45	
75.3	31	31	31	31	31	31	31	31	32	32	
	45	45	46	46	46	47	47	47	48	48	
75.4	32	32	32	32	32	32	33	33	33	33	
	48	49	49	49	50	50	50	51	51	51	
75.5	33	33	33	33	33	34	34	34	34	34	
	51	52	52	52	53	53	53	54	54	55	
75.6	34	34	34	34	35	35	35	35	35	35	
	55	55	56	56	56	57	57	57	58	58	
75.7	35	35	35	36	36	36	36	36	36	36	
	58	59	59	59	60	60	60	61	61	62	
75.8	36	37	37	37	37	37	37	37	37	37	
	62	62	63	63	63	64	64	64	65	65	
75.9	38	38	38	38	38	38	38	38	38	39	
	66	66	66	67	67	67	68	68	69	69	

Table 7-02

Elevation-Area/Capacity Table - Barker Reservoir

Elevation (ft) NAVD 1988	Area (acres)	Area (acres)	Area (acres)	Area (acres)	Area (acres)	Area (acres)	Area (acres)	Area (acres)	Area (acres)	Area (acres)	Area (acres)
	Capacity (Ac-ft)	Capacity (Ac-ft)	Capacity (Ac-ft)	Capacity (Ac-ft)	Capacity (Ac-ft)	Capacity (Ac-ft)	Capacity (Ac-ft)	Capacity (Ac-ft)	Capacity (Ac-ft)	Capacity (Ac-ft)	Capacity (Ac-ft)
	0	0.01	0.02	0.03	0.04	0.05	0.06	0.07	0.08	0.09	
76	39	39	39	39	40	40	40	40	41	41	
	69	70	70	71	71	71	72	72	73	73	
76.1	41	41	41	42	42	42	42	43	43	43	
	73	74	74	75	75	75	76	76	77	77	
76.2	43	44	44	44	44	44	45	45	45	45	
	78	78	78	79	79	80	80	81	81	82	
76.3	46	46	46	46	47	47	47	47	48	48	
	82	83	83	83	84	84	85	85	86	86	
76.4	48	48	49	49	49	49	50	50	50	50	
	87	87	88	88	89	89	90	90	91	91	
76.5	51	51	51	51	52	52	52	52	53	53	
	92	92	93	93	94	94	95	95	96	96	
76.6	53	53	54	54	54	54	55	55	55	56	
	97	97	98	98	99	100	100	101	101	102	
76.7	56	56	56	57	57	57	57	58	58	58	
	102	103	103	104	105	105	106	106	107	107	
76.8	58	59	59	59	60	60	60	60	61	61	
	108	109	109	110	110	111	112	112	113	113	
76.9	61	62	62	62	62	63	63	63	63	64	
	114	115	115	116	116	117	118	118	119	120	
77	64	65	65	66	67	68	68	69	70	71	
	120	121	122	122	123	124	124	125	126	126	
77.1	71	72	73	74	74	75	76	77	78	78	
	127	128	129	129	130	131	131	132	133	134	
77.2	79	80	81	82	82	83	84	85	86	87	
	135	135	136	137	138	139	139	140	141	142	
77.3	87	88	89	90	91	92	92	93	94	95	
	143	144	145	146	146	147	148	149	150	151	
77.4	96	97	98	99	99	100	101	102	103	104	
	152	153	154	155	156	157	158	159	160	161	
77.5	105	106	107	108	109	110	110	111	112	113	
	162	163	164	165	166	167	169	170	171	172	
77.6	114	115	116	117	118	119	120	121	122	123	
	173	174	175	177	178	179	180	181	183	184	
77.7	124	125	126	127	128	129	130	131	132	133	
	185	186	187	189	190	191	193	194	195	197	
77.8	134	135	136	137	138	139	141	142	143	144	
	198	199	201	202	203	205	206	208	209	210	
77.9	145	146	147	148	149	150	151	152	154	155	
	212	213	215	216	218	219	221	222	224	225	

Table 7-02

Elevation-Area/Capacity Table - Barker Reservoir

Elevation (ft) NAVD 1988	Area (acres)	Area (acres)	Area (acres)	Area (acres)	Area (acres)	Area (acres)	Area (acres)	Area (acres)	Area (acres)	Area (acres)	Area (acres)
	Capacity (Ac-ft)	Capacity (Ac-ft)	Capacity (Ac-ft)	Capacity (Ac-ft)	Capacity (Ac-ft)	Capacity (Ac-ft)	Capacity (Ac-ft)	Capacity (Ac-ft)	Capacity (Ac-ft)	Capacity (Ac-ft)	Capacity (Ac-ft)
	0	0.01	0.02	0.03	0.04	0.05	0.06	0.07	0.08	0.09	
78	156	156	157	157	158	159	159	160	160	161	
	227	228	230	232	233	235	236	238	240	241	
78.1	161	162	162	163	163	164	165	165	166	166	
	243	244	246	248	249	251	252	254	256	257	
78.2	167	167	168	169	169	170	170	171	171	172	
	259	261	262	264	266	268	269	271	273	274	
78.3	173	173	174	174	175	175	176	177	177	178	
	276	278	280	281	283	285	287	288	290	292	
78.4	178	179	179	180	181	181	182	182	183	184	
	294	295	297	299	301	303	304	306	308	310	
78.5	184	185	185	186	187	187	188	188	189	190	
	312	314	315	317	319	321	323	325	327	329	
78.6	190	191	191	192	193	193	194	194	195	196	
	330	332	334	336	338	340	342	344	346	348	
78.7	196	197	197	198	199	199	200	200	201	202	
	350	352	354	356	358	360	362	364	366	368	
78.8	202	203	204	204	205	205	206	207	207	208	
	370	372	374	376	378	380	382	384	386	388	
78.9	209	209	210	210	211	212	212	213	214	214	
	390	392	394	397	399	401	403	405	407	409	
79	215	216	217	218	219	221	222	223	224	225	
	411	414	416	418	420	422	425	427	429	431	
79.1	226	227	229	230	231	232	233	234	236	237	
	433	436	438	440	443	445	447	450	452	454	
79.2	238	239	240	241	243	244	245	246	247	249	
	457	459	461	464	466	469	471	474	476	479	
79.3	250	251	252	254	255	256	257	258	260	261	
	481	484	486	489	491	494	496	499	501	504	
79.4	262	263	265	266	267	268	270	271	272	273	
	507	509	512	515	517	520	523	525	528	531	
79.5	275	276	277	278	280	281	282	284	285	286	
	533	536	539	542	545	547	550	553	556	559	
79.6	287	289	290	291	293	294	295	297	298	299	
	562	564	567	570	573	576	579	582	585	588	
79.7	301	302	303	305	306	307	309	310	311	313	
	591	594	597	600	603	606	609	612	615	619	
79.8	314	315	317	318	319	321	322	324	325	326	
	622	625	628	631	634	638	641	644	647	651	
79.9	328	329	331	332	333	335	336	338	339	340	
	654	657	660	664	667	670	674	677	680	684	

Table 7-02

Elevation-Area/Capacity Table - Barker Reservoir

Elevation (ft) NAVD 1988	Area (acres)	Area (acres)	Area (acres)	Area (acres)	Area (acres)	Area (acres)	Area (acres)	Area (acres)	Area (acres)	Area (acres)	Area (acres)
	Capacity (Ac-ft) 0	Capacity (Ac-ft) 0.01	Capacity (Ac-ft) 0.02	Capacity (Ac-ft) 0.03	Capacity (Ac-ft) 0.04	Capacity (Ac-ft) 0.05	Capacity (Ac-ft) 0.06	Capacity (Ac-ft) 0.07	Capacity (Ac-ft) 0.08	Capacity (Ac-ft) 0.09	
80	342	343	344	345	346	347	348	350	351	352	
	687	691	694	698	701	704	708	711	715	718	
80.1	353	354	355	356	357	359	360	361	362	363	
	722	726	729	733	736	740	743	747	751	754	
80.2	364	365	366	368	369	370	371	372	373	375	
	758	762	765	769	773	776	780	784	787	791	
80.3	376	377	378	379	380	382	383	384	385	386	
	795	799	802	806	810	814	818	821	825	829	
80.4	387	389	390	391	392	393	394	396	397	398	
	833	837	841	845	849	853	856	860	864	868	
80.5	399	400	402	403	404	405	406	408	409	410	
	872	876	880	884	888	892	897	901	905	909	
80.6	411	413	414	415	416	417	419	420	421	422	
	913	917	921	925	929	934	938	942	946	950	
80.7	424	425	426	427	428	430	431	432	433	435	
	955	959	963	967	972	976	980	985	989	993	
80.8	436	437	438	440	441	442	443	445	446	447	
	998	1,002	1,006	1,011	1,015	1,020	1,024	1,028	1,033	1,037	
80.9	448	450	451	452	454	455	456	457	459	460	
	1,042	1,046	1,051	1,055	1,060	1,064	1,069	1,073	1,078	1,083	
81	461	464	467	469	472	475	478	480	483	486	
	1,087	1,092	1,097	1,101	1,106	1,111	1,115	1,120	1,125	1,130	
81.1	489	492	494	497	500	503	506	509	511	514	
	1,135	1,140	1,145	1,150	1,155	1,160	1,165	1,170	1,175	1,180	
81.2	517	520	523	526	529	532	535	538	540	543	
	1,185	1,190	1,195	1,201	1,206	1,211	1,217	1,222	1,227	1,233	
81.3	546	549	552	555	558	561	564	567	570	573	
	1,238	1,244	1,249	1,255	1,260	1,266	1,272	1,277	1,283	1,289	
81.4	576	579	582	586	589	592	595	598	601	604	
	1,294	1,300	1,306	1,312	1,318	1,324	1,329	1,335	1,341	1,347	
81.5	607	610	613	617	620	623	626	629	632	636	
	1,354	1,360	1,366	1,372	1,378	1,384	1,391	1,397	1,403	1,409	
81.6	639	642	645	648	652	655	658	661	665	668	
	1,416	1,422	1,429	1,435	1,442	1,448	1,455	1,461	1,468	1,475	
81.7	671	674	678	681	684	688	691	694	698	701	
	1,481	1,488	1,495	1,502	1,508	1,515	1,522	1,529	1,536	1,543	
81.8	704	708	711	714	718	721	725	728	731	735	
	1,550	1,557	1,564	1,571	1,579	1,586	1,593	1,600	1,608	1,615	
81.9	738	742	745	749	752	756	759	763	766	770	
	1,622	1,630	1,637	1,645	1,652	1,660	1,667	1,675	1,682	1,690	

Table 7-02

Elevation-Area/Capacity Table - Barker Reservoir

Elevation (ft) NAVD 1988	Area (acres)	Area (acres)	Area (acres)	Area (acres)	Area (acres)	Area (acres)	Area (acres)	Area (acres)	Area (acres)	Area (acres)	Area (acres)
	Capacity (Ac-ft) 0	Capacity (Ac-ft) 0.01	Capacity (Ac-ft) 0.02	Capacity (Ac-ft) 0.03	Capacity (Ac-ft) 0.04	Capacity (Ac-ft) 0.05	Capacity (Ac-ft) 0.06	Capacity (Ac-ft) 0.07	Capacity (Ac-ft) 0.08	Capacity (Ac-ft) 0.09	
82	773	777	780	784	787	791	794	798	802	805	
	1,698	1,706	1,713	1,721	1,729	1,737	1,745	1,753	1,761	1,769	
82.1	809	812	816	820	823	827	831	834	838	842	
	1,777	1,785	1,793	1,801	1,810	1,818	1,826	1,834	1,843	1,851	
82.2	845	849	853	856	860	864	868	871	875	879	
	1,860	1,868	1,877	1,885	1,894	1,902	1,911	1,920	1,928	1,937	
82.3	883	886	890	894	898	902	905	909	913	917	
	1,946	1,955	1,964	1,973	1,982	1,991	2,000	2,009	2,018	2,027	
82.4	921	925	928	932	936	940	944	948	952	956	
	2,036	2,045	2,055	2,064	2,073	2,083	2,092	2,102	2,111	2,121	
82.5	960	964	967	971	975	979	983	987	991	995	
	2,130	2,140	2,149	2,159	2,169	2,179	2,188	2,198	2,208	2,218	
82.6	999	1,003	1,007	1,011	1,015	1,019	1,023	1,028	1,032	1,036	
	2,228	2,238	2,248	2,258	2,268	2,279	2,289	2,299	2,309	2,320	
82.7	1,040	1,044	1,048	1,052	1,056	1,060	1,064	1,069	1,073	1,077	
	2,330	2,340	2,351	2,361	2,372	2,383	2,393	2,404	2,414	2,425	
82.8	1,081	1,085	1,089	1,094	1,098	1,102	1,106	1,110	1,115	1,119	
	2,436	2,447	2,458	2,469	2,480	2,491	2,502	2,513	2,524	2,535	
82.9	1,123	1,127	1,132	1,136	1,140	1,145	1,149	1,153	1,157	1,162	
	2,546	2,557	2,569	2,580	2,592	2,603	2,614	2,626	2,637	2,649	
83	1,166	1,171	1,176	1,181	1,186	1,191	1,196	1,201	1,206	1,211	
	2,661	2,672	2,684	2,696	2,708	2,720	2,732	2,744	2,756	2,768	
83.1	1,216	1,221	1,226	1,231	1,236	1,242	1,247	1,252	1,257	1,262	
	2,780	2,792	2,804	2,817	2,829	2,841	2,854	2,866	2,879	2,891	
83.2	1,267	1,272	1,278	1,283	1,288	1,293	1,298	1,304	1,309	1,314	
	2,904	2,917	2,929	2,942	2,955	2,968	2,981	2,994	3,007	3,020	
83.3	1,319	1,325	1,330	1,335	1,340	1,346	1,351	1,356	1,362	1,367	
	3,033	3,046	3,060	3,073	3,086	3,100	3,113	3,127	3,141	3,154	
83.4	1,372	1,378	1,383	1,389	1,394	1,399	1,405	1,410	1,416	1,421	
	3,168	3,182	3,195	3,209	3,223	3,237	3,251	3,265	3,279	3,294	
83.5	1,427	1,432	1,438	1,443	1,449	1,454	1,460	1,465	1,471	1,476	
	3,308	3,322	3,336	3,351	3,365	3,380	3,394	3,409	3,424	3,438	
83.6	1,482	1,487	1,493	1,499	1,504	1,510	1,516	1,521	1,527	1,533	
	3,453	3,468	3,483	3,498	3,513	3,528	3,543	3,558	3,574	3,589	
83.7	1,538	1,544	1,550	1,555	1,561	1,567	1,572	1,578	1,584	1,590	
	3,604	3,620	3,635	3,651	3,666	3,682	3,698	3,713	3,729	3,745	
83.8	1,596	1,601	1,607	1,613	1,619	1,625	1,630	1,636	1,642	1,648	
	3,761	3,777	3,793	3,809	3,825	3,841	3,858	3,874	3,890	3,907	
83.9	1,654	1,660	1,666	1,672	1,678	1,684	1,689	1,695	1,701	1,707	
	3,923	3,940	3,957	3,973	3,990	4,007	4,024	4,041	4,058	4,075	

Table 7-02

Elevation-Area/Capacity Table - Barker Reservoir

Elevation (ft) NAVD 1988	Area (acres)	Area (acres)	Area (acres)	Area (acres)	Area (acres)	Area (acres)	Area (acres)	Area (acres)	Area (acres)	Area (acres)	Area (acres)
	Capacity (Ac-ft)	Capacity (Ac-ft)	Capacity (Ac-ft)	Capacity (Ac-ft)	Capacity (Ac-ft)	Capacity (Ac-ft)	Capacity (Ac-ft)	Capacity (Ac-ft)	Capacity (Ac-ft)	Capacity (Ac-ft)	Capacity (Ac-ft)
	0	0.01	0.02	0.03	0.04	0.05	0.06	0.07	0.08	0.09	
84	1,713	1,719	1,724	1,729	1,734	1,740	1,745	1,750	1,756	1,761	
	4,092	4,109	4,126	4,143	4,161	4,178	4,195	4,213	4,230	4,248	
84.1	1,766	1,772	1,777	1,782	1,788	1,793	1,798	1,804	1,809	1,815	
	4,266	4,283	4,301	4,319	4,337	4,355	4,373	4,391	4,409	4,427	
84.2	1,820	1,825	1,831	1,836	1,842	1,847	1,853	1,858	1,864	1,869	
	4,445	4,463	4,482	4,500	4,518	4,537	4,555	4,574	4,592	4,611	
84.3	1,874	1,880	1,885	1,891	1,897	1,902	1,908	1,913	1,919	1,924	
	4,630	4,648	4,667	4,686	4,705	4,724	4,743	4,762	4,781	4,801	
84.4	1,930	1,935	1,941	1,947	1,952	1,958	1,963	1,969	1,975	1,980	
	4,820	4,839	4,859	4,878	4,898	4,917	4,937	4,956	4,976	4,996	
84.5	1,986	1,992	1,997	2,003	2,009	2,014	2,020	2,026	2,031	2,037	
	5,016	5,036	5,056	5,076	5,096	5,116	5,136	5,156	5,176	5,197	
84.6	2,043	2,049	2,054	2,060	2,066	2,072	2,077	2,083	2,089	2,095	
	5,217	5,238	5,258	5,279	5,299	5,320	5,341	5,362	5,382	5,403	
84.7	2,101	2,106	2,112	2,118	2,124	2,130	2,136	2,141	2,147	2,153	
	5,424	5,445	5,466	5,488	5,509	5,530	5,551	5,573	5,594	5,616	
84.8	2,159	2,165	2,171	2,177	2,183	2,189	2,195	2,200	2,206	2,212	
	5,637	5,659	5,681	5,702	5,724	5,746	5,768	5,790	5,812	5,834	
84.9	2,218	2,224	2,230	2,236	2,242	2,248	2,254	2,260	2,266	2,272	
	5,856	5,878	5,901	5,923	5,945	5,968	5,990	6,013	6,036	6,058	
85	2,279	2,285	2,291	2,298	2,304	2,311	2,317	2,323	2,330	2,336	
	6,081	6,104	6,127	6,150	6,173	6,196	6,219	6,242	6,265	6,289	
85.1	2,343	2,349	2,356	2,362	2,369	2,375	2,382	2,388	2,395	2,401	
	6,312	6,335	6,359	6,383	6,406	6,430	6,454	6,478	6,502	6,525	
85.2	2,408	2,414	2,421	2,428	2,434	2,441	2,447	2,454	2,461	2,467	
	6,550	6,574	6,598	6,622	6,646	6,671	6,695	6,720	6,744	6,769	
85.3	2,474	2,480	2,487	2,494	2,500	2,507	2,514	2,521	2,527	2,534	
	6,794	6,818	6,843	6,868	6,893	6,918	6,943	6,968	6,994	7,019	
85.4	2,541	2,547	2,554	2,561	2,568	2,575	2,581	2,588	2,595	2,602	
	7,044	7,070	7,095	7,121	7,146	7,172	7,198	7,224	7,250	7,276	
85.5	2,609	2,615	2,622	2,629	2,636	2,643	2,650	2,656	2,663	2,670	
	7,302	7,328	7,354	7,380	7,407	7,433	7,460	7,486	7,513	7,539	
85.6	2,677	2,684	2,691	2,698	2,705	2,712	2,719	2,726	2,733	2,740	
	7,566	7,593	7,620	7,647	7,674	7,701	7,728	7,755	7,782	7,810	
85.7	2,747	2,754	2,761	2,768	2,775	2,782	2,789	2,796	2,803	2,810	
	7,837	7,865	7,892	7,920	7,948	7,975	8,003	8,031	8,059	8,087	
85.8	2,817	2,824	2,831	2,839	2,846	2,853	2,860	2,867	2,874	2,881	
	8,115	8,144	8,172	8,200	8,229	8,257	8,286	8,314	8,343	8,372	
85.9	2,889	2,896	2,903	2,910	2,917	2,925	2,932	2,939	2,946	2,954	
	8,401	8,430	8,459	8,488	8,517	8,546	8,575	8,605	8,634	8,664	

Table 7-02

Elevation-Area/Capacity Table - Barker Reservoir

Elevation (ft) NAVD 1988	Area (acres)	Area (acres)	Area (acres)	Area (acres)	Area (acres)	Area (acres)	Area (acres)	Area (acres)	Area (acres)	Area (acres)	Area (acres)
	Capacity (Ac-ft)	Capacity (Ac-ft)	Capacity (Ac-ft)	Capacity (Ac-ft)	Capacity (Ac-ft)	Capacity (Ac-ft)	Capacity (Ac-ft)	Capacity (Ac-ft)	Capacity (Ac-ft)	Capacity (Ac-ft)	Capacity (Ac-ft)
	0	0.01	0.02	0.03	0.04	0.05	0.06	0.07	0.08	0.09	
86	2,961	2,968	2,975	2,982	2,988	2,995	3,002	3,009	3,016	3,023	
	8,693	8,723	8,753	8,782	8,812	8,842	8,872	8,902	8,932	8,962	
86.1	3,030	3,037	3,044	3,051	3,058	3,065	3,072	3,079	3,086	3,093	
	8,993	9,023	9,053	9,084	9,114	9,145	9,176	9,207	9,237	9,268	
86.2	3,100	3,107	3,114	3,121	3,128	3,136	3,143	3,150	3,157	3,164	
	9,299	9,330	9,361	9,393	9,424	9,455	9,487	9,518	9,550	9,581	
86.3	3,171	3,178	3,185	3,193	3,200	3,207	3,214	3,221	3,228	3,236	
	9,613	9,645	9,676	9,708	9,740	9,772	9,804	9,837	9,869	9,901	
86.4	3,243	3,250	3,257	3,264	3,272	3,279	3,286	3,293	3,301	3,308	
	9,933	9,966	9,998	10,031	10,064	10,097	10,129	10,162	10,195	10,228	
86.5	3,315	3,323	3,330	3,337	3,345	3,352	3,359	3,367	3,374	3,381	
	10,261	10,295	10,328	10,361	10,395	10,428	10,462	10,495	10,529	10,563	
86.6	3,389	3,396	3,403	3,411	3,418	3,426	3,433	3,440	3,448	3,455	
	10,597	10,631	10,665	10,699	10,733	10,767	10,801	10,836	10,870	10,905	
86.7	3,463	3,470	3,478	3,485	3,493	3,500	3,508	3,515	3,523	3,530	
	10,939	10,974	11,009	11,043	11,078	11,113	11,148	11,183	11,219	11,254	
86.8	3,538	3,545	3,553	3,560	3,568	3,575	3,583	3,591	3,598	3,606	
	11,289	11,325	11,360	11,396	11,431	11,467	11,503	11,539	11,575	11,611	
86.9	3,613	3,621	3,629	3,636	3,644	3,651	3,659	3,667	3,674	3,682	
	11,647	11,683	11,719	11,755	11,792	11,828	11,865	11,901	11,938	11,975	
87	3,690	3,699	3,708	3,717	3,727	3,736	3,745	3,754	3,764	3,773	
	12,012	12,049	12,086	12,123	12,160	12,197	12,235	12,272	12,310	12,348	
87.1	3,782	3,792	3,801	3,810	3,820	3,829	3,838	3,848	3,857	3,867	
	12,385	12,423	12,461	12,499	12,537	12,576	12,614	12,652	12,691	12,730	
87.2	3,876	3,885	3,895	3,904	3,914	3,923	3,933	3,942	3,952	3,961	
	12,768	12,807	12,846	12,885	12,924	12,963	13,003	13,042	13,081	13,121	
87.3	3,971	3,980	3,990	3,999	4,009	4,019	4,028	4,038	4,047	4,057	
	13,161	13,200	13,240	13,280	13,320	13,360	13,401	13,441	13,481	13,522	
87.4	4,067	4,076	4,086	4,096	4,105	4,115	4,125	4,135	4,144	4,154	
	13,563	13,603	13,644	13,685	13,726	13,767	13,808	13,850	13,891	13,932	
87.5	4,164	4,174	4,183	4,193	4,203	4,213	4,223	4,232	4,242	4,252	
	13,974	14,016	14,058	14,099	14,141	14,183	14,226	14,268	14,310	14,353	
87.6	4,262	4,272	4,282	4,292	4,302	4,312	4,321	4,331	4,341	4,351	
	14,395	14,438	14,481	14,524	14,567	14,610	14,653	14,696	14,739	14,783	
87.7	4,361	4,371	4,381	4,391	4,401	4,411	4,422	4,432	4,442	4,452	
	14,826	14,870	14,914	14,958	15,002	15,046	15,090	15,134	15,179	15,223	
87.8	4,462	4,472	4,482	4,492	4,502	4,513	4,523	4,533	4,543	4,553	
	15,268	15,312	15,357	15,402	15,447	15,492	15,537	15,582	15,628	15,673	
87.9	4,564	4,574	4,584	4,594	4,605	4,615	4,625	4,635	4,646	4,656	
	15,719	15,765	15,810	15,856	15,902	15,948	15,995	16,041	16,087	16,134	

Table 7-02

Elevation-Area/Capacity Table - Barker Reservoir

Elevation (ft) NAVD 1988	Area (acres)	Area (acres)	Area (acres)	Area (acres)	Area (acres)	Area (acres)	Area (acres)	Area (acres)	Area (acres)	Area (acres)	Area (acres)
	Capacity (Ac-ft)	Capacity (Ac-ft)	Capacity (Ac-ft)	Capacity (Ac-ft)	Capacity (Ac-ft)	Capacity (Ac-ft)	Capacity (Ac-ft)	Capacity (Ac-ft)	Capacity (Ac-ft)	Capacity (Ac-ft)	Capacity (Ac-ft)
	0	0.01	0.02	0.03	0.04	0.05	0.06	0.07	0.08	0.09	
88	4,666	4,678	4,690	4,702	4,714	4,726	4,738	4,750	4,762	4,774	
	16,180	16,227	16,274	16,321	16,368	16,415	16,463	16,510	16,558	16,605	
88.1	4,786	4,798	4,811	4,823	4,835	4,847	4,859	4,871	4,883	4,896	
	16,653	16,701	16,749	16,797	16,845	16,894	16,942	16,991	17,040	17,089	
88.2	4,908	4,920	4,932	4,945	4,957	4,969	4,981	4,994	5,006	5,018	
	17,138	17,187	17,236	17,286	17,335	17,385	17,434	17,484	17,534	17,584	
88.3	5,031	5,043	5,056	5,068	5,080	5,093	5,105	5,118	5,130	5,143	
	17,635	17,685	17,736	17,786	17,837	17,888	17,939	17,990	18,041	18,092	
88.4	5,155	5,168	5,180	5,193	5,206	5,218	5,231	5,243	5,256	5,269	
	18,144	18,196	18,247	18,299	18,351	18,403	18,456	18,508	18,560	18,613	
88.5	5,281	5,294	5,307	5,320	5,332	5,345	5,358	5,371	5,383	5,396	
	18,666	18,719	18,772	18,825	18,878	18,931	18,985	19,039	19,092	19,146	
88.6	5,409	5,422	5,435	5,448	5,461	5,473	5,486	5,499	5,512	5,525	
	19,200	19,254	19,309	19,363	19,418	19,472	19,527	19,582	19,637	19,692	
88.7	5,538	5,551	5,564	5,577	5,590	5,603	5,616	5,629	5,643	5,656	
	19,748	19,803	19,859	19,914	19,970	20,026	20,082	20,138	20,195	20,251	
88.8	5,669	5,682	5,695	5,708	5,721	5,735	5,748	5,761	5,774	5,788	
	20,308	20,365	20,422	20,479	20,536	20,593	20,650	20,708	20,766	20,823	
88.9	5,801	5,814	5,828	5,841	5,854	5,868	5,881	5,894	5,908	5,921	
	20,881	20,940	20,998	21,056	21,115	21,173	21,232	21,291	21,350	21,409	
89	5,935	5,958	5,982	6,006	6,030	6,053	6,077	6,101	6,125	6,149	
	21,468	21,528	21,587	21,647	21,707	21,768	21,829	21,889	21,951	22,012	
89.1	6,174	6,198	6,222	6,246	6,270	6,295	6,319	6,344	6,368	6,393	
	22,074	22,135	22,198	22,260	22,322	22,385	22,448	22,512	22,575	22,639	
89.2	6,417	6,442	6,466	6,491	6,516	6,541	6,566	6,590	6,615	6,640	
	22,703	22,767	22,832	22,897	22,962	23,027	23,093	23,158	23,224	23,291	
89.3	6,665	6,691	6,716	6,741	6,766	6,791	6,817	6,842	6,867	6,893	
	23,357	23,424	23,491	23,558	23,626	23,694	23,762	23,830	23,898	23,967	
89.4	6,918	6,944	6,970	6,995	7,021	7,047	7,073	7,098	7,124	7,150	
	24,036	24,106	24,175	24,245	24,315	24,385	24,456	24,527	24,598	24,669	
89.5	7,176	7,202	7,228	7,254	7,281	7,307	7,333	7,359	7,386	7,412	
	24,741	24,813	24,885	24,957	25,030	25,103	25,176	25,250	25,323	25,397	
89.6	7,439	7,465	7,492	7,518	7,545	7,572	7,598	7,625	7,652	7,679	
	25,472	25,546	25,621	25,696	25,771	25,847	25,923	25,999	26,075	26,152	
89.7	7,706	7,733	7,760	7,787	7,814	7,841	7,868	7,896	7,923	7,950	
	26,229	26,306	26,384	26,461	26,539	26,618	26,696	26,775	26,854	26,933	
89.8	7,978	8,005	8,033	8,060	8,088	8,115	8,143	8,171	8,199	8,226	
	27,013	27,093	27,173	27,254	27,334	27,415	27,497	27,578	27,660	27,742	
89.9	8,254	8,282	8,310	8,338	8,366	8,394	8,423	8,451	8,479	8,507	
	27,825	27,907	27,990	28,073	28,157	28,241	28,325	28,409	28,494	28,579	

Table 7-02

Elevation-Area/Capacity Table - Barker Reservoir

Elevation (ft) NAVD 1988	Area (acres)	Area (acres)	Area (acres)	Area (acres)	Area (acres)	Area (acres)	Area (acres)	Area (acres)	Area (acres)	Area (acres)	Area (acres)
	Capacity (Ac-ft)	Capacity (Ac-ft)	Capacity (Ac-ft)	Capacity (Ac-ft)	Capacity (Ac-ft)	Capacity (Ac-ft)	Capacity (Ac-ft)	Capacity (Ac-ft)	Capacity (Ac-ft)	Capacity (Ac-ft)	Capacity (Ac-ft)
	0	0.01	0.02	0.03	0.04	0.05	0.06	0.07	0.08	0.09	0.09
90	8,536	8,552	8,568	8,584	8,600	8,616	8,632	8,649	8,665	8,681	
	28,664	28,749	28,835	28,921	29,007	29,093	29,179	29,265	29,352	29,439	
90.1	8,697	8,714	8,730	8,746	8,762	8,779	8,795	8,811	8,828	8,844	
	29,526	29,613	29,700	29,787	29,875	29,963	30,050	30,138	30,227	30,315	
90.2	8,861	8,877	8,893	8,910	8,926	8,943	8,959	8,976	8,992	9,009	
	30,404	30,492	30,581	30,670	30,759	30,849	30,938	31,028	31,118	31,208	
90.3	9,025	9,042	9,058	9,075	9,092	9,108	9,125	9,141	9,158	9,175	
	31,298	31,388	31,479	31,569	31,660	31,751	31,842	31,934	32,025	32,117	
90.4	9,191	9,208	9,225	9,242	9,258	9,275	9,292	9,309	9,326	9,342	
	32,209	32,301	32,393	32,485	32,578	32,670	32,763	32,856	32,949	33,043	
90.5	9,359	9,376	9,393	9,410	9,427	9,444	9,461	9,478	9,495	9,511	
	33,136	33,230	33,324	33,418	33,512	33,606	33,701	33,795	33,890	33,985	
90.6	9,528	9,546	9,563	9,580	9,597	9,614	9,631	9,648	9,665	9,682	
	34,081	34,176	34,271	34,367	34,463	34,559	34,655	34,752	34,848	34,945	
90.7	9,699	9,716	9,734	9,751	9,768	9,785	9,802	9,820	9,837	9,854	
	35,042	35,139	35,236	35,334	35,431	35,529	35,627	35,725	35,823	35,922	
90.8	9,872	9,889	9,906	9,924	9,941	9,958	9,976	9,993	10,011	10,028	
	36,020	36,119	36,218	36,317	36,417	36,516	36,616	36,716	36,816	36,916	
90.9	10,045	10,063	10,080	10,098	10,115	10,133	10,150	10,168	10,186	10,203	
	37,016	37,117	37,218	37,318	37,420	37,521	37,622	37,724	37,826	37,927	
91	10,221	10,227	10,233	10,239	10,245	10,251	10,257	10,263	10,269	10,275	
	38,030	38,132	38,234	38,336	38,439	38,541	38,644	38,747	38,849	38,952	
91.1	10,281	10,287	10,293	10,299	10,305	10,311	10,317	10,323	10,329	10,335	
	39,055	39,157	39,260	39,363	39,466	39,569	39,673	39,776	39,879	39,982	
91.2	10,341	10,347	10,353	10,359	10,365	10,371	10,377	10,383	10,389	10,395	
	40,086	40,189	40,293	40,396	40,500	40,604	40,707	40,811	40,915	41,019	
91.3	10,401	10,407	10,413	10,419	10,425	10,431	10,437	10,444	10,450	10,456	
	41,123	41,227	41,331	41,435	41,539	41,644	41,748	41,852	41,957	42,061	
91.4	10,462	10,468	10,474	10,480	10,486	10,492	10,498	10,504	10,510	10,516	
	42,166	42,271	42,375	42,480	42,585	42,690	42,795	42,900	43,005	43,110	
91.5	10,522	10,528	10,535	10,541	10,547	10,553	10,559	10,565	10,571	10,577	
	43,215	43,320	43,426	43,531	43,637	43,742	43,848	43,953	44,059	44,165	
91.6	10,583	10,589	10,595	10,602	10,608	10,614	10,620	10,626	10,632	10,638	
	44,270	44,376	44,482	44,588	44,694	44,800	44,907	45,013	45,119	45,225	
91.7	10,644	10,650	10,657	10,663	10,669	10,675	10,681	10,687	10,693	10,699	
	45,332	45,438	45,545	45,651	45,758	45,865	45,972	46,078	46,185	46,292	
91.8	10,705	10,712	10,718	10,724	10,730	10,736	10,742	10,748	10,755	10,761	
	46,399	46,506	46,614	46,721	46,828	46,935	47,043	47,150	47,258	47,365	
91.9	10,767	10,773	10,779	10,785	10,791	10,798	10,804	10,810	10,816	10,822	
	47,473	47,581	47,688	47,796	47,904	48,012	48,120	48,228	48,336	48,444	

Table 7-02

Elevation-Area/Capacity Table - Barker Reservoir

Elevation (ft) NAVD 1988	Area (acres)	Area (acres)	Area (acres)	Area (acres)	Area (acres)	Area (acres)	Area (acres)	Area (acres)	Area (acres)	Area (acres)	Area (acres)
	Capacity (Ac-ft)	Capacity (Ac-ft)	Capacity (Ac-ft)	Capacity (Ac-ft)	Capacity (Ac-ft)	Capacity (Ac-ft)	Capacity (Ac-ft)	Capacity (Ac-ft)	Capacity (Ac-ft)	Capacity (Ac-ft)	Capacity (Ac-ft)
	0	0.01	0.02	0.03	0.04	0.05	0.06	0.07	0.08	0.09	
92	10,828	10,834	10,839	10,844	10,849	10,854	10,859	10,864	10,869	10,874	
	48,553	48,661	48,769	48,878	48,986	49,095	49,203	49,312	49,421	49,529	
92.1	10,879	10,885	10,890	10,895	10,900	10,905	10,910	10,915	10,920	10,925	
	49,638	49,747	49,856	49,965	50,074	50,183	50,292	50,401	50,510	50,619	
92.2	10,931	10,936	10,941	10,946	10,951	10,956	10,961	10,966	10,972	10,977	
	50,729	50,838	50,947	51,057	51,166	51,276	51,385	51,495	51,605	51,714	
92.3	10,982	10,987	10,992	10,997	11,002	11,008	11,013	11,018	11,023	11,028	
	51,824	51,934	52,044	52,154	52,264	52,374	52,484	52,594	52,704	52,815	
92.4	11,033	11,038	11,044	11,049	11,054	11,059	11,064	11,069	11,074	11,080	
	52,925	53,035	53,146	53,256	53,367	53,477	53,588	53,699	53,809	53,920	
92.5	11,085	11,090	11,095	11,100	11,105	11,111	11,116	11,121	11,126	11,131	
	54,031	54,142	54,253	54,364	54,475	54,586	54,697	54,808	54,919	55,031	
92.6	11,136	11,142	11,147	11,152	11,157	11,162	11,167	11,173	11,178	11,183	
	55,142	55,253	55,365	55,476	55,588	55,699	55,811	55,923	56,034	56,146	
92.7	11,188	11,193	11,198	11,204	11,209	11,214	11,219	11,224	11,230	11,235	
	56,258	56,370	56,482	56,594	56,706	56,818	56,930	57,043	57,155	57,267	
92.8	11,240	11,245	11,250	11,256	11,261	11,266	11,271	11,276	11,282	11,287	
	57,380	57,492	57,604	57,717	57,830	57,942	58,055	58,168	58,280	58,393	
92.9	11,292	11,297	11,302	11,308	11,313	11,318	11,323	11,328	11,334	11,339	
	58,506	58,619	58,732	58,845	58,958	59,071	59,185	59,298	59,411	59,525	
93	11,344	11,347	11,349	11,352	11,354	11,356	11,359	11,361	11,364	11,366	
	59,638	59,751	59,865	59,978	60,092	60,205	60,319	60,433	60,546	60,660	
93.1	11,369	11,371	11,374	11,376	11,379	11,381	11,384	11,386	11,389	11,391	
	60,774	60,887	61,001	61,115	61,229	61,342	61,456	61,570	61,684	61,798	
93.2	11,394	11,396	11,399	11,401	11,404	11,406	11,409	11,411	11,414	11,416	
	61,912	62,026	62,140	62,254	62,368	62,482	62,596	62,710	62,824	62,938	
93.3	11,419	11,421	11,424	11,426	11,429	11,431	11,434	11,436	11,439	11,441	
	63,052	63,167	63,281	63,395	63,509	63,624	63,738	63,852	63,967	64,081	
93.4	11,444	11,446	11,449	11,451	11,454	11,456	11,459	11,461	11,464	11,466	
	64,195	64,310	64,424	64,539	64,653	64,768	64,883	64,997	65,112	65,226	
93.5	11,469	11,471	11,474	11,476	11,479	11,481	11,484	11,486	11,489	11,491	
	65,341	65,456	65,571	65,685	65,800	65,915	66,030	66,144	66,259	66,374	
93.6	11,494	11,496	11,499	11,501	11,504	11,506	11,509	11,511	11,514	11,516	
	66,489	66,604	66,719	66,834	66,949	67,064	67,179	67,294	67,409	67,525	
93.7	11,519	11,521	11,524	11,526	11,529	11,531	11,534	11,536	11,539	11,541	
	67,640	67,755	67,870	67,985	68,101	68,216	68,331	68,447	68,562	68,677	
93.8	11,544	11,546	11,549	11,551	11,554	11,556	11,559	11,561	11,564	11,566	
	68,793	68,908	69,024	69,139	69,255	69,370	69,486	69,602	69,717	69,833	
93.9	11,569	11,571	11,574	11,576	11,579	11,581	11,584	11,586	11,589	11,591	
	69,949	70,064	70,180	70,296	70,411	70,527	70,643	70,759	70,875	70,991	

Table 7-02

Elevation-Area/Capacity Table - Barker Reservoir

Elevation (ft) NAVD 1988	Area (acres)	Area (acres)	Area (acres)	Area (acres)	Area (acres)	Area (acres)	Area (acres)	Area (acres)	Area (acres)	Area (acres)	Area (acres)
	Capacity (Ac-ft)	Capacity (Ac-ft)	Capacity (Ac-ft)	Capacity (Ac-ft)	Capacity (Ac-ft)	Capacity (Ac-ft)	Capacity (Ac-ft)	Capacity (Ac-ft)	Capacity (Ac-ft)	Capacity (Ac-ft)	Capacity (Ac-ft)
	0	0.01	0.02	0.03	0.04	0.05	0.06	0.07	0.08	0.09	
94	11,594	11,598	11,603	11,607	11,611	11,616	11,620	11,624	11,629	11,633	
	71,107	71,223	71,339	71,455	71,571	71,687	71,803	71,919	72,036	72,152	
94.1	11,638	11,642	11,646	11,651	11,655	11,660	11,664	11,668	11,673	11,677	
	72,268	72,385	72,501	72,618	72,734	72,851	72,967	73,084	73,201	73,317	
94.2	11,682	11,686	11,690	11,695	11,699	11,704	11,708	11,712	11,717	11,721	
	73,434	73,551	73,668	73,785	73,902	74,019	74,136	74,253	74,370	74,487	
94.3	11,726	11,730	11,734	11,739	11,743	11,748	11,752	11,756	11,761	11,765	
	74,605	74,722	74,839	74,956	75,074	75,191	75,309	75,426	75,544	75,662	
94.4	11,770	11,774	11,778	11,783	11,787	11,792	11,796	11,800	11,805	11,809	
	75,779	75,897	76,015	76,133	76,250	76,368	76,486	76,604	76,722	76,840	
94.5	11,814	11,818	11,823	11,827	11,831	11,836	11,840	11,845	11,849	11,854	
	76,958	77,077	77,195	77,313	77,431	77,550	77,668	77,786	77,905	78,023	
94.6	11,858	11,862	11,867	11,871	11,876	11,880	11,885	11,889	11,893	11,898	
	78,142	78,261	78,379	78,498	78,617	78,735	78,854	78,973	79,092	79,211	
94.7	11,902	11,907	11,911	11,916	11,920	11,924	11,929	11,933	11,938	11,942	
	79,330	79,449	79,568	79,687	79,806	79,926	80,045	80,164	80,284	80,403	
94.8	11,947	11,951	11,956	11,960	11,964	11,969	11,973	11,978	11,982	11,987	
	80,522	80,642	80,762	80,881	81,001	81,120	81,240	81,360	81,480	81,599	
94.9	11,991	11,996	12,000	12,005	12,009	12,013	12,018	12,022	12,027	12,031	
	81,719	81,839	81,959	82,079	82,199	82,319	82,440	82,560	82,680	82,800	
95	12,036	12,038	12,040	12,042	12,045	12,047	12,049	12,052	12,054	12,056	
	82,921	83,041	83,161	83,282	83,402	83,523	83,643	83,764	83,884	84,005	
95.1	12,058	12,061	12,063	12,065	12,067	12,070	12,072	12,074	12,076	12,079	
	84,125	84,246	84,367	84,487	84,608	84,729	84,849	84,970	85,091	85,212	
95.2	12,081	12,083	12,085	12,088	12,090	12,092	12,094	12,097	12,099	12,101	
	85,332	85,453	85,574	85,695	85,816	85,937	86,058	86,179	86,300	86,421	
95.3	12,103	12,106	12,108	12,110	12,113	12,115	12,117	12,119	12,122	12,124	
	86,542	86,663	86,784	86,905	87,026	87,147	87,268	87,389	87,511	87,632	
95.4	12,126	12,128	12,131	12,133	12,135	12,137	12,140	12,142	12,144	12,147	
	87,753	87,874	87,996	88,117	88,238	88,360	88,481	88,602	88,724	88,845	
95.5	12,149	12,151	12,153	12,156	12,158	12,160	12,162	12,165	12,167	12,169	
	88,967	89,088	89,210	89,331	89,453	89,575	89,696	89,818	89,939	90,061	
95.6	12,171	12,174	12,176	12,178	12,181	12,183	12,185	12,187	12,190	12,192	
	90,183	90,305	90,426	90,548	90,670	90,792	90,914	91,035	91,157	91,279	
95.7	12,194	12,196	12,199	12,201	12,203	12,206	12,208	12,210	12,212	12,215	
	91,401	91,523	91,645	91,767	91,889	92,011	92,133	92,255	92,377	92,500	
95.8	12,217	12,219	12,221	12,224	12,226	12,228	12,231	12,233	12,235	12,237	
	92,622	92,744	92,866	92,988	93,111	93,233	93,355	93,477	93,600	93,722	
95.9	12,240	12,242	12,244	12,246	12,249	12,251	12,253	12,256	12,258	12,260	
	93,844	93,967	94,089	94,212	94,334	94,457	94,579	94,702	94,824	94,947	

Table 7-02

Elevation-Area/Capacity Table - Barker Reservoir

Elevation (ft) NAVD 1988	Area (acres)	Area (acres)	Area (acres)	Area (acres)	Area (acres)	Area (acres)	Area (acres)	Area (acres)	Area (acres)	Area (acres)	Area (acres)
	Capacity (Ac-ft)	Capacity (Ac-ft)	Capacity (Ac-ft)	Capacity (Ac-ft)	Capacity (Ac-ft)	Capacity (Ac-ft)	Capacity (Ac-ft)	Capacity (Ac-ft)	Capacity (Ac-ft)	Capacity (Ac-ft)	Capacity (Ac-ft)
	0	0.01	0.02	0.03	0.04	0.05	0.06	0.07	0.08	0.09	
96	12,262	12,266	12,269	12,272	12,275	12,278	12,281	12,284	12,287	12,291	
	95,070	95,192	95,315	95,438	95,560	95,683	95,806	95,929	96,052	96,174	
96.1	12,294	12,297	12,300	12,303	12,306	12,309	12,312	12,316	12,319	12,322	
	96,297	96,420	96,543	96,666	96,789	96,912	97,036	97,159	97,282	97,405	
96.2	12,325	12,328	12,331	12,334	12,338	12,341	12,344	12,347	12,350	12,353	
	97,528	97,652	97,775	97,898	98,022	98,145	98,268	98,392	98,515	98,639	
96.3	12,356	12,359	12,363	12,366	12,369	12,372	12,375	12,378	12,381	12,385	
	98,762	98,886	99,010	99,133	99,257	99,381	99,504	99,628	99,752	99,876	
96.4	12,388	12,391	12,394	12,397	12,400	12,403	12,407	12,410	12,413	12,416	
	100,000	100,123	100,247	100,371	100,495	100,619	100,743	100,868	100,992	101,116	
96.5	12,419	12,422	12,425	12,429	12,432	12,435	12,438	12,441	12,444	12,447	
	101,240	101,364	101,488	101,613	101,737	101,861	101,986	102,110	102,234	102,359	
96.6	12,451	12,454	12,457	12,460	12,463	12,466	12,470	12,473	12,476	12,479	
	102,483	102,608	102,733	102,857	102,982	103,106	103,231	103,356	103,480	103,605	
96.7	12,482	12,485	12,488	12,492	12,495	12,498	12,501	12,504	12,507	12,511	
	103,730	103,855	103,980	104,105	104,230	104,355	104,480	104,605	104,730	104,855	
96.8	12,514	12,517	12,520	12,523	12,526	12,530	12,533	12,536	12,539	12,542	
	104,980	105,105	105,230	105,355	105,481	105,606	105,731	105,857	105,982	106,107	
96.9	12,545	12,548	12,552	12,555	12,558	12,561	12,564	12,567	12,571	12,574	
	106,233	106,358	106,484	106,609	106,735	106,860	106,986	107,112	107,237	107,363	
97	12,577	12,583	12,589	12,595	12,601	12,608	12,614	12,620	12,626	12,632	
	107,489	107,615	107,741	107,867	107,992	108,119	108,245	108,371	108,497	108,623	
97.1	12,638	12,645	12,651	12,657	12,663	12,669	12,675	12,681	12,688	12,694	
	108,750	108,876	109,003	109,129	109,256	109,382	109,509	109,636	109,763	109,890	
97.2	12,700	12,706	12,712	12,718	12,725	12,731	12,737	12,743	12,749	12,755	
	110,017	110,144	110,271	110,398	110,525	110,652	110,780	110,907	111,035	111,162	
97.3	12,762	12,768	12,774	12,780	12,786	12,793	12,799	12,805	12,811	12,817	
	111,290	111,417	111,545	111,673	111,801	111,929	112,056	112,185	112,313	112,441	
97.4	12,823	12,830	12,836	12,842	12,848	12,854	12,861	12,867	12,873	12,879	
	112,569	112,697	112,826	112,954	113,082	113,211	113,339	113,468	113,597	113,726	
97.5	12,885	12,892	12,898	12,904	12,910	12,917	12,923	12,929	12,935	12,941	
	113,854	113,983	114,112	114,241	114,370	114,499	114,629	114,758	114,887	115,017	
97.6	12,948	12,954	12,960	12,966	12,973	12,979	12,985	12,991	12,997	13,004	
	115,146	115,276	115,405	115,535	115,664	115,794	115,924	116,054	116,184	116,314	
97.7	13,010	13,016	13,022	13,029	13,035	13,041	13,047	13,054	13,060	13,066	
	116,444	116,574	116,704	116,834	116,965	117,095	117,226	117,356	117,487	117,617	
97.8	13,072	13,079	13,085	13,091	13,097	13,104	13,110	13,116	13,122	13,129	
	117,748	117,879	118,010	118,140	118,271	118,402	118,533	118,665	118,796	118,927	
97.9	13,135	13,141	13,148	13,154	13,160	13,166	13,173	13,179	13,185	13,191	
	119,058	119,190	119,321	119,453	119,584	119,716	119,848	119,979	120,111	120,243	

Table 7-02

Elevation-Area/Capacity Table - Barker Reservoir

Elevation (ft) NAVD 1988	Area (acres)	Area (acres)	Area (acres)	Area (acres)	Area (acres)	Area (acres)	Area (acres)	Area (acres)	Area (acres)	Area (acres)	Area (acres)
	Capacity (Ac-ft)	Capacity (Ac-ft)	Capacity (Ac-ft)	Capacity (Ac-ft)	Capacity (Ac-ft)	Capacity (Ac-ft)	Capacity (Ac-ft)	Capacity (Ac-ft)	Capacity (Ac-ft)	Capacity (Ac-ft)	Capacity (Ac-ft)
	0	0.01	0.02	0.03	0.04	0.05	0.06	0.07	0.08	0.09	
98	13,198	13,204	13,210	13,216	13,222	13,228	13,234	13,240	13,246	13,253	
	120,375	120,507	120,639	120,771	120,903	121,036	121,168	121,300	121,433	121,565	
98.1	13,259	13,265	13,271	13,277	13,283	13,289	13,295	13,301	13,307	13,314	
	121,698	121,830	121,963	122,096	122,229	122,362	122,494	122,627	122,760	122,894	
98.2	13,320	13,326	13,332	13,338	13,344	13,350	13,356	13,362	13,369	13,375	
	123,027	123,160	123,293	123,427	123,560	123,694	123,827	123,961	124,094	124,228	
98.3	13,381	13,387	13,393	13,399	13,405	13,411	13,418	13,424	13,430	13,436	
	124,362	124,496	124,630	124,763	124,898	125,032	125,166	125,300	125,434	125,569	
98.4	13,442	13,448	13,454	13,461	13,467	13,473	13,479	13,485	13,491	13,497	
	125,703	125,837	125,972	126,106	126,241	126,376	126,511	126,645	126,780	126,915	
98.5	13,504	13,510	13,516	13,522	13,528	13,534	13,541	13,547	13,553	13,559	
	127,050	127,185	127,320	127,456	127,591	127,726	127,862	127,997	128,132	128,268	
98.6	13,565	13,571	13,577	13,584	13,590	13,596	13,602	13,608	13,615	13,621	
	128,404	128,539	128,675	128,811	128,947	129,083	129,219	129,355	129,491	129,627	
98.7	13,627	13,633	13,639	13,645	13,652	13,658	13,664	13,670	13,676	13,683	
	129,763	129,900	130,036	130,172	130,309	130,445	130,582	130,719	130,855	130,992	
98.8	13,689	13,695	13,701	13,707	13,714	13,720	13,726	13,732	13,738	13,745	
	131,129	131,266	131,403	131,540	131,677	131,814	131,951	132,089	132,226	132,364	
98.9	13,751	13,757	13,763	13,769	13,776	13,782	13,788	13,794	13,800	13,807	
	132,501	132,639	132,776	132,914	133,052	133,189	133,327	133,465	133,603	133,741	
99	13,813	13,818	13,823	13,828	13,833	13,839	13,844	13,849	13,854	13,859	
	133,879	134,017	134,156	134,294	134,432	134,570	134,709	134,847	134,986	135,124	
99.1	13,864	13,870	13,875	13,880	13,885	13,890	13,895	13,901	13,906	13,911	
	135,263	135,402	135,540	135,679	135,818	135,957	136,096	136,235	136,374	136,513	
99.2	13,916	13,921	13,926	13,932	13,937	13,942	13,947	13,952	13,957	13,963	
	136,652	136,791	136,931	137,070	137,209	137,349	137,488	137,627	137,767	137,907	
99.3	13,968	13,973	13,978	13,983	13,989	13,994	13,999	14,004	14,009	14,014	
	138,046	138,186	138,326	138,466	138,605	138,745	138,885	139,025	139,165	139,305	
99.4	14,020	14,025	14,030	14,035	14,040	14,046	14,051	14,056	14,061	14,066	
	139,446	139,586	139,726	139,866	140,007	140,147	140,288	140,428	140,569	140,710	
99.5	14,072	14,077	14,082	14,087	14,092	14,098	14,103	14,108	14,113	14,118	
	140,850	140,991	141,132	141,273	141,413	141,554	141,695	141,836	141,978	142,119	
99.6	14,124	14,129	14,134	14,139	14,144	14,150	14,155	14,160	14,165	14,170	
	142,260	142,401	142,543	142,684	142,825	142,967	143,108	143,250	143,392	143,533	
99.7	14,176	14,181	14,186	14,191	14,197	14,202	14,207	14,212	14,217	14,223	
	143,675	143,817	143,959	144,100	144,242	144,384	144,526	144,668	144,811	144,953	
99.8	14,228	14,233	14,238	14,244	14,249	14,254	14,259	14,264	14,270	14,275	
	145,095	145,237	145,380	145,522	145,665	145,807	145,950	146,092	146,235	146,378	
99.9	14,280	14,285	14,291	14,296	14,301	14,306	14,312	14,317	14,322	14,327	
	146,520	146,663	146,806	146,949	147,092	147,235	147,378	147,521	147,665	147,808	

Table 7-02

Elevation-Area/Capacity Table - Barker Reservoir

Elevation (ft) NAVD 1988	Area (acres)	Area (acres)	Area (acres)	Area (acres)	Area (acres)	Area (acres)	Area (acres)	Area (acres)	Area (acres)	Area (acres)	Area (acres)
	Capacity (Ac-ft)	Capacity (Ac-ft)	Capacity (Ac-ft)	Capacity (Ac-ft)	Capacity (Ac-ft)	Capacity (Ac-ft)	Capacity (Ac-ft)	Capacity (Ac-ft)	Capacity (Ac-ft)	Capacity (Ac-ft)	Capacity (Ac-ft)
	0	0.01	0.02	0.03	0.04	0.05	0.06	0.07	0.08	0.09	
100	14,333	14,338	14,343	14,348	14,353	14,358	14,363	14,369	14,374	14,379	
	147,951	148,094	148,238	148,381	148,525	148,668	148,812	148,956	149,099	149,243	
100.1	14,384	14,389	14,394	14,399	14,404	14,410	14,415	14,420	14,425	14,430	
	149,387	149,531	149,675	149,819	149,963	150,107	150,251	150,395	150,539	150,684	
100.2	14,435	14,441	14,446	14,451	14,456	14,461	14,466	14,471	14,477	14,482	
	150,828	150,972	151,117	151,261	151,406	151,550	151,695	151,840	151,984	152,129	
100.3	14,487	14,492	14,497	14,502	14,508	14,513	14,518	14,523	14,528	14,533	
	152,274	152,419	152,564	152,709	152,854	152,999	153,144	153,289	153,435	153,580	
100.4	14,539	14,544	14,549	14,554	14,559	14,564	14,570	14,575	14,580	14,585	
	153,725	153,871	154,016	154,162	154,307	154,453	154,599	154,744	154,890	155,036	
100.5	14,590	14,595	14,601	14,606	14,611	14,616	14,621	14,627	14,632	14,637	
	155,182	155,328	155,474	155,620	155,766	155,912	156,058	156,204	156,351	156,497	
100.6	14,642	14,647	14,652	14,658	14,663	14,668	14,673	14,678	14,684	14,689	
	156,643	156,790	156,936	157,083	157,229	157,376	157,523	157,670	157,816	157,963	
100.7	14,694	14,699	14,704	14,710	14,715	14,720	14,725	14,730	14,736	14,741	
	158,110	158,257	158,404	158,551	158,698	158,846	158,993	159,140	159,287	159,435	
100.8	14,746	14,751	14,756	14,762	14,767	14,772	14,777	14,783	14,788	14,793	
	159,582	159,730	159,877	160,025	160,172	160,320	160,468	160,616	160,764	160,911	
100.9	14,798	14,803	14,809	14,814	14,819	14,824	14,829	14,835	14,840	14,845	
	161,059	161,207	161,355	161,504	161,652	161,800	161,948	162,097	162,245	162,393	
101	14,850	14,856	14,861	14,866	14,872	14,877	14,882	14,888	14,893	14,898	
	162,542	162,690	162,839	162,988	163,136	163,285	163,434	163,583	163,732	163,880	
101.1	14,903	14,909	14,914	14,919	14,925	14,930	14,935	14,941	14,946	14,951	
	164,029	164,179	164,328	164,477	164,626	164,775	164,925	165,074	165,223	165,373	
101.2	14,957	14,962	14,967	14,973	14,978	14,983	14,989	14,994	14,999	15,005	
	165,523	165,672	165,822	165,971	166,121	166,271	166,421	166,571	166,721	166,871	
101.3	15,010	15,015	15,021	15,026	15,031	15,037	15,042	15,047	15,053	15,058	
	167,021	167,171	167,321	167,471	167,622	167,772	167,922	168,073	168,223	168,374	
101.4	15,063	15,069	15,074	15,079	15,085	15,090	15,095	15,101	15,106	15,112	
	168,524	168,675	168,826	168,977	169,127	169,278	169,429	169,580	169,731	169,882	
101.5	15,117	15,122	15,128	15,133	15,138	15,144	15,149	15,154	15,160	15,165	
	170,034	170,185	170,336	170,487	170,639	170,790	170,941	171,093	171,245	171,396	
101.6	15,170	15,176	15,181	15,187	15,192	15,197	15,203	15,208	15,213	15,219	
	171,548	171,700	171,851	172,003	172,155	172,307	172,459	172,611	172,763	172,915	
101.7	15,224	15,230	15,235	15,240	15,246	15,251	15,256	15,262	15,267	15,273	
	173,068	173,220	173,372	173,525	173,677	173,829	173,982	174,135	174,287	174,440	
101.8	15,278	15,283	15,289	15,294	15,299	15,305	15,310	15,316	15,321	15,326	
	174,593	174,746	174,898	175,051	175,204	175,357	175,510	175,663	175,817	175,970	
101.9	15,332	15,337	15,343	15,348	15,353	15,359	15,364	15,370	15,375	15,380	
	176,123	176,277	176,430	176,583	176,737	176,890	177,044	177,198	177,351	177,505	

Table 7-02

Elevation-Area/Capacity Table - Barker Reservoir

Elevation (ft) NAVD 1988	Area (acres)	Area (acres)	Area (acres)	Area (acres)	Area (acres)	Area (acres)	Area (acres)	Area (acres)	Area (acres)	Area (acres)	Area (acres)
	Capacity (Ac-ft)	Capacity (Ac-ft)	Capacity (Ac-ft)	Capacity (Ac-ft)	Capacity (Ac-ft)	Capacity (Ac-ft)	Capacity (Ac-ft)	Capacity (Ac-ft)	Capacity (Ac-ft)	Capacity (Ac-ft)	Capacity (Ac-ft)
	0	0.01	0.02	0.03	0.04	0.05	0.06	0.07	0.08	0.09	
102	15,386	15,392	15,397	15,403	15,409	15,415	15,421	15,426	15,432	15,438	
	177,659	177,813	177,967	178,121	178,275	178,429	178,583	178,737	178,892	179,046	
102.1	15,444	15,450	15,455	15,461	15,467	15,473	15,479	15,484	15,490	15,496	
	179,201	179,355	179,510	179,664	179,819	179,973	180,128	180,283	180,438	180,593	
102.2	15,502	15,508	15,513	15,519	15,525	15,531	15,537	15,542	15,548	15,554	
	180,748	180,903	181,058	181,213	181,368	181,524	181,679	181,834	181,990	182,145	
102.3	15,560	15,566	15,572	15,577	15,583	15,589	15,595	15,601	15,606	15,612	
	182,301	182,457	182,612	182,768	182,924	183,080	183,236	183,392	183,548	183,704	
102.4	15,618	15,624	15,630	15,636	15,641	15,647	15,653	15,659	15,665	15,671	
	183,860	184,016	184,172	184,329	184,485	184,641	184,798	184,954	185,111	185,268	
102.5	15,676	15,682	15,688	15,694	15,700	15,706	15,712	15,717	15,723	15,729	
	185,425	185,581	185,738	185,895	186,052	186,209	186,366	186,523	186,681	186,838	
102.6	15,735	15,741	15,747	15,753	15,758	15,764	15,770	15,776	15,782	15,788	
	186,995	187,152	187,310	187,467	187,625	187,783	187,940	188,098	188,256	188,414	
102.7	15,794	15,799	15,805	15,811	15,817	15,823	15,829	15,835	15,840	15,846	
	188,572	188,729	188,888	189,046	189,204	189,362	189,520	189,679	189,837	189,995	
102.8	15,852	15,858	15,864	15,870	15,876	15,882	15,887	15,893	15,899	15,905	
	190,154	190,312	190,471	190,630	190,788	190,947	191,106	191,265	191,424	191,583	
102.9	15,911	15,917	15,923	15,929	15,935	15,940	15,946	15,952	15,958	15,964	
	191,742	191,901	192,060	192,220	192,379	192,538	192,698	192,857	193,017	193,176	
103	15,970	15,976	15,981	15,987	15,993	15,998	16,004	16,010	16,015	16,021	
	193,336	193,496	193,656	193,815	193,975	194,135	194,295	194,455	194,615	194,776	
103.1	16,027	16,032	16,038	16,044	16,050	16,055	16,061	16,067	16,072	16,078	
	194,936	195,096	195,257	195,417	195,577	195,738	195,898	196,059	196,220	196,381	
103.2	16,084	16,089	16,095	16,101	16,106	16,112	16,118	16,124	16,129	16,135	
	196,541	196,702	196,863	197,024	197,185	197,346	197,507	197,669	197,830	197,991	
103.3	16,141	16,146	16,152	16,158	16,164	16,169	16,175	16,181	16,186	16,192	
	198,153	198,314	198,476	198,637	198,799	198,960	199,122	199,284	199,446	199,608	
103.4	16,198	16,204	16,209	16,215	16,221	16,226	16,232	16,238	16,244	16,249	
	199,770	199,932	200,094	200,256	200,418	200,580	200,742	200,905	201,067	201,230	
103.5	16,255	16,261	16,267	16,272	16,278	16,284	16,289	16,295	16,301	16,307	
	201,392	201,555	201,717	201,880	202,043	202,206	202,369	202,531	202,694	202,857	
103.6	16,312	16,318	16,324	16,330	16,335	16,341	16,347	16,353	16,358	16,364	
	203,021	203,184	203,347	203,510	203,674	203,837	204,000	204,164	204,327	204,491	
103.7	16,370	16,376	16,381	16,387	16,393	16,399	16,404	16,410	16,416	16,422	
	204,655	204,818	204,982	205,146	205,310	205,474	205,638	205,802	205,966	206,130	
103.8	16,427	16,433	16,439	16,445	16,450	16,456	16,462	16,468	16,474	16,479	
	206,295	206,459	206,623	206,788	206,952	207,117	207,281	207,446	207,611	207,775	
103.9	16,485	16,491	16,497	16,502	16,508	16,514	16,520	16,525	16,531	16,537	
	207,940	208,105	208,270	208,435	208,600	208,765	208,930	209,096	209,261	209,426	

Table 7-02

Elevation-Area/Capacity Table - Barker Reservoir

Elevation (ft) NAVD 1988	Area (acres)	Area (acres)	Area (acres)	Area (acres)	Area (acres)	Area (acres)	Area (acres)	Area (acres)	Area (acres)	Area (acres)	Area (acres)
	Capacity (Ac-ft)	Capacity (Ac-ft)	Capacity (Ac-ft)	Capacity (Ac-ft)	Capacity (Ac-ft)	Capacity (Ac-ft)	Capacity (Ac-ft)	Capacity (Ac-ft)	Capacity (Ac-ft)	Capacity (Ac-ft)	Capacity (Ac-ft)
	0	0.01	0.02	0.03	0.04	0.05	0.06	0.07	0.08	0.09	
104	16,543 209,592	16,549 209,757	16,556 209,923	16,562 210,088	16,569 210,254	16,575 210,419	16,582 210,585	16,588 210,751	16,594 210,917	16,601 211,083	
104.1	16,607 211,249	16,614 211,415	16,620 211,581	16,627 211,748	16,633 211,914	16,640 212,080	16,646 212,247	16,653 212,413	16,659 212,580	16,666 212,746	
104.2	16,672 212,913	16,679 213,080	16,685 213,247	16,692 213,413	16,698 213,580	16,705 213,747	16,711 213,915	16,718 214,082	16,724 214,249	16,730 214,416	
104.3	16,737 214,583	16,743 214,751	16,750 214,918	16,756 215,086	16,763 215,253	16,769 215,421	16,776 215,589	16,782 215,757	16,789 215,925	16,795 216,092	
104.4	16,802 216,260	16,808 216,428	16,815 216,597	16,821 216,765	16,828 216,933	16,834 217,101	16,841 217,270	16,848 217,438	16,854 217,607	16,861 217,775	
104.5	16,867 217,944	16,874 218,113	16,880 218,281	16,887 218,450	16,893 218,619	16,900 218,788	16,906 218,957	16,913 219,126	16,919 219,295	16,926 219,465	
104.6	16,932 219,634	16,939 219,803	16,945 219,973	16,952 220,142	16,958 220,312	16,965 220,481	16,971 220,651	16,978 220,821	16,985 220,991	16,991 221,160	
104.7	16,998 221,330	17,004 221,500	17,011 221,670	17,017 221,841	17,024 222,011	17,030 222,181	17,037 222,351	17,043 222,522	17,050 222,692	17,057 222,863	
104.8	17,063 223,033	17,070 223,204	17,076 223,375	17,083 223,546	17,089 223,716	17,096 223,887	17,102 224,058	17,109 224,229	17,116 224,401	17,122 224,572	
104.9	17,129 224,743	17,135 224,914	17,142 225,086	17,148 225,257	17,155 225,429	17,162 225,600	17,168 225,772	17,175 225,944	17,181 226,115	17,188 226,287	
105	17,194 226,459	17,202 226,631	17,209 226,803	17,216 226,975	17,223 227,147	17,231 227,320	17,238 227,492	17,245 227,665	17,253 227,837	17,260 228,010	
105.1	17,267 228,182	17,274 228,355	17,282 228,528	17,289 228,701	17,296 228,873	17,303 229,046	17,311 229,220	17,318 229,393	17,325 229,566	17,332 229,739	
105.2	17,340 229,913	17,347 230,086	17,354 230,259	17,362 230,433	17,369 230,607	17,376 230,780	17,383 230,954	17,391 231,128	17,398 231,302	17,405 231,476	
105.3	17,413 231,650	17,420 231,824	17,427 231,999	17,435 232,173	17,442 232,347	17,449 232,522	17,456 232,696	17,464 232,871	17,471 233,046	17,478 233,220	
105.4	17,486 233,395	17,493 233,570	17,500 233,745	17,508 233,920	17,515 234,095	17,522 234,270	17,530 234,446	17,537 234,621	17,544 234,796	17,552 234,972	
105.5	17,559 235,147	17,566 235,323	17,574 235,499	17,581 235,674	17,588 235,850	17,596 236,026	17,603 236,202	17,610 236,378	17,618 236,554	17,625 236,731	
105.6	17,632 236,907	17,640 237,083	17,647 237,260	17,654 237,436	17,662 237,613	17,669 237,789	17,676 237,966	17,684 238,143	17,691 238,320	17,698 238,497	
105.7	17,706 238,674	17,713 238,851	17,720 239,028	17,728 239,205	17,735 239,383	17,743 239,560	17,750 239,737	17,757 239,915	17,765 240,093	17,772 240,270	
105.8	17,779 240,448	17,787 240,626	17,794 240,804	17,801 240,982	17,809 241,160	17,816 241,338	17,824 241,516	17,831 241,694	17,838 241,873	17,846 242,051	
105.9	17,853 242,230	17,861 242,408	17,868 242,587	17,875 242,766	17,883 242,944	17,890 243,123	17,898 243,302	17,905 243,481	17,912 243,660	17,920 243,839	

Table 7-02

Elevation-Area/Capacity Table - Barker Reservoir

Elevation (ft) NAVD 1988	Area (acres)	Area (acres)	Area (acres)	Area (acres)	Area (acres)	Area (acres)	Area (acres)	Area (acres)	Area (acres)	Area (acres)	Area (acres)
	Capacity (Ac-ft)	Capacity (Ac-ft)	Capacity (Ac-ft)	Capacity (Ac-ft)	Capacity (Ac-ft)	Capacity (Ac-ft)	Capacity (Ac-ft)	Capacity (Ac-ft)	Capacity (Ac-ft)	Capacity (Ac-ft)	Capacity (Ac-ft)
	0	0.01	0.02	0.03	0.04	0.05	0.06	0.07	0.08	0.09	
106	17,927	17,934	17,941	17,948	17,955	17,962	17,968	17,975	17,982	17,989	
	244,019	244,198	244,377	244,557	244,736	244,916	245,096	245,275	245,455	245,635	
106.1	17,996	18,003	18,010	18,017	18,024	18,031	18,037	18,044	18,051	18,058	
	245,815	245,995	246,175	246,355	246,535	246,715	246,896	247,076	247,257	247,437	
106.2	18,065	18,072	18,079	18,086	18,093	18,100	18,107	18,113	18,120	18,127	
	247,618	247,799	247,979	248,160	248,341	248,522	248,703	248,884	249,065	249,247	
106.3	18,134	18,141	18,148	18,155	18,162	18,169	18,176	18,183	18,190	18,197	
	249,428	249,609	249,791	249,972	250,154	250,335	250,517	250,699	250,881	251,063	
106.4	18,204	18,210	18,217	18,224	18,231	18,238	18,245	18,252	18,259	18,266	
	251,245	251,427	251,609	251,791	251,973	252,156	252,338	252,521	252,703	252,886	
106.5	18,273	18,280	18,287	18,294	18,301	18,308	18,315	18,322	18,329	18,336	
	253,069	253,251	253,434	253,617	253,800	253,983	254,166	254,349	254,533	254,716	
106.6	18,343	18,350	18,356	18,363	18,370	18,377	18,384	18,391	18,398	18,405	
	254,899	255,083	255,266	255,450	255,634	255,817	256,001	256,185	256,369	256,553	
106.7	18,412	18,419	18,426	18,433	18,440	18,447	18,454	18,461	18,468	18,475	
	256,737	256,921	257,105	257,290	257,474	257,659	257,843	258,028	258,212	258,397	
106.8	18,482	18,489	18,496	18,503	18,510	18,517	18,524	18,531	18,538	18,545	
	258,582	258,767	258,952	259,137	259,322	259,507	259,692	259,877	260,063	260,248	
106.9	18,552	18,559	18,566	18,573	18,580	18,587	18,594	18,601	18,608	18,615	
	260,433	260,619	260,805	260,990	261,176	261,362	261,548	261,734	261,920	262,106	
107	18,622	18,629	18,636	18,643	18,650	18,657	18,664	18,671	18,678	18,685	
	262,292	262,478	262,665	262,851	263,038	263,224	263,411	263,597	263,784	263,971	
107.1	18,692	18,699	18,706	18,713	18,720	18,728	18,735	18,742	18,749	18,756	
	264,158	264,345	264,532	264,719	264,906	265,093	265,281	265,468	265,656	265,843	
107.2	18,763	18,770	18,777	18,784	18,791	18,798	18,805	18,812	18,819	18,826	
	266,031	266,218	266,406	266,594	266,782	266,970	267,158	267,346	267,534	267,722	
107.3	18,833	18,840	18,847	18,854	18,861	18,869	18,876	18,883	18,890	18,897	
	267,910	268,099	268,287	268,476	268,664	268,853	269,042	269,230	269,419	269,608	
107.4	18,904	18,911	18,918	18,925	18,932	18,939	18,946	18,953	18,960	18,968	
	269,797	269,986	270,176	270,365	270,554	270,743	270,933	271,122	271,312	271,502	
107.5	18,975	18,982	18,989	18,996	19,003	19,010	19,017	19,024	19,031	19,038	
	271,691	271,881	272,071	272,261	272,451	272,641	272,831	273,021	273,211	273,402	
107.6	19,045	19,053	19,060	19,067	19,074	19,081	19,088	19,095	19,102	19,109	
	273,592	273,783	273,973	274,164	274,355	274,545	274,736	274,927	275,118	275,309	
107.7	19,116	19,124	19,131	19,138	19,145	19,152	19,159	19,166	19,173	19,181	
	275,500	275,692	275,883	276,074	276,266	276,457	276,649	276,840	277,032	277,224	
107.8	19,188	19,195	19,202	19,209	19,216	19,223	19,230	19,238	19,245	19,252	
	277,416	277,607	277,799	277,991	278,184	278,376	278,568	278,760	278,953	279,145	
107.9	19,259	19,266	19,273	19,280	19,287	19,295	19,302	19,309	19,316	19,323	
	279,338	279,530	279,723	279,916	280,109	280,302	280,495	280,688	280,881	281,074	

Table 7-02

Elevation-Area/Capacity Table - Barker Reservoir

Elevation (ft) NAVD 1988	Area (acres)	Area (acres)	Area (acres)	Area (acres)	Area (acres)	Area (acres)	Area (acres)	Area (acres)	Area (acres)	Area (acres)	Area (acres)
	Capacity (Ac-ft)	Capacity (Ac-ft)	Capacity (Ac-ft)	Capacity (Ac-ft)	Capacity (Ac-ft)	Capacity (Ac-ft)	Capacity (Ac-ft)	Capacity (Ac-ft)	Capacity (Ac-ft)	Capacity (Ac-ft)	Capacity (Ac-ft)
	0	0.01	0.02	0.03	0.04	0.05	0.06	0.07	0.08	0.09	
108	19,330 281,267	19,333 281,461	19,336 281,654	19,339 281,847	19,342 282,041	19,345 282,234	19,348 282,428	19,351 282,621	19,354 282,815	19,357 283,008	
108.1	19,360 283,202	19,363 283,395	19,365 283,589	19,368 283,783	19,371 283,976	19,374 284,170	19,377 284,364	19,380 284,558	19,383 284,752	19,386 284,945	
108.2	19,389 285,139	19,392 285,333	19,395 285,527	19,398 285,721	19,401 285,915	19,403 286,109	19,406 286,303	19,409 286,497	19,412 286,691	19,415 286,885	
108.3	19,418 287,080	19,421 287,274	19,424 287,468	19,427 287,662	19,430 287,857	19,433 288,051	19,436 288,245	19,439 288,440	19,442 288,634	19,445 288,828	
108.4	19,447 289,023	19,450 289,217	19,453 289,412	19,456 289,606	19,459 289,801	19,462 289,996	19,465 290,190	19,468 290,385	19,471 290,580	19,474 290,774	
108.5	19,477 290,969	19,480 291,164	19,483 291,359	19,486 291,553	19,489 291,748	19,491 291,943	19,494 292,138	19,497 292,333	19,500 292,528	19,503 292,723	
108.6	19,506 292,918	19,509 293,113	19,512 293,308	19,515 293,504	19,518 293,699	19,521 293,894	19,524 294,089	19,527 294,284	19,530 294,480	19,533 294,675	
108.7	19,536 294,870	19,538 295,066	19,541 295,261	19,544 295,456	19,547 295,652	19,550 295,847	19,553 296,043	19,556 296,239	19,559 296,434	19,562 296,630	
108.8	19,565 296,825	19,568 297,021	19,571 297,217	19,574 297,412	19,577 297,608	19,580 297,804	19,583 298,000	19,586 298,196	19,588 298,391	19,591 298,587	
108.9	19,594 298,783	19,597 298,979	19,600 299,175	19,603 299,371	19,606 299,567	19,609 299,763	19,612 299,959	19,615 300,156	19,618 300,352	19,621 300,548	
109	19,624 300,744	19,629 300,940	19,634 301,137	19,640 301,333	19,645 301,530	19,651 301,726	19,656 301,923	19,661 302,119	19,667 302,316	19,672 302,512	
109.1	19,677 302,709	19,683 302,906	19,688 303,103	19,693 303,300	19,699 303,497	19,704 303,694	19,709 303,891	19,715 304,088	19,720 304,285	19,726 304,482	
109.2	19,731 304,680	19,736 304,877	19,742 305,074	19,747 305,272	19,752 305,469	19,758 305,667	19,763 305,864	19,768 306,062	19,774 306,260	19,779 306,458	
109.3	19,785 306,655	19,790 306,853	19,795 307,051	19,801 307,249	19,806 307,447	19,811 307,645	19,817 307,843	19,822 308,042	19,827 308,240	19,833 308,438	
109.4	19,838 308,637	19,844 308,835	19,849 309,033	19,854 309,232	19,860 309,431	19,865 309,629	19,870 309,828	19,876 310,027	19,881 310,225	19,887 310,424	
109.5	19,892 310,623	19,897 310,822	19,903 311,021	19,908 311,220	19,914 311,419	19,919 311,618	19,924 311,818	19,930 312,017	19,935 312,216	19,940 312,416	
109.6	19,946 312,615	19,951 312,814	19,957 313,014	19,962 313,214	19,967 313,413	19,973 313,613	19,978 313,813	19,984 314,012	19,989 314,212	19,994 314,412	
109.7	20,000 314,612	20,005 314,812	20,011 315,012	20,016 315,212	20,021 315,413	20,027 315,613	20,032 315,813	20,038 316,014	20,043 316,214	20,048 316,414	
109.8	20,054 316,615	20,059 316,815	20,065 317,016	20,070 317,217	20,075 317,418	20,081 317,618	20,086 317,819	20,092 318,020	20,097 318,221	20,103 318,422	
109.9	20,108 318,623	20,113 318,824	20,119 319,025	20,124 319,226	20,130 319,428	20,135 319,629	20,140 319,830	20,146 320,032	20,151 320,233	20,157 320,435	

Table 7-02

Elevation-Area/Capacity Table - Barker Reservoir

Elevation (ft) NAVD 1988	Area (acres)	Area (acres)	Area (acres)	Area (acres)	Area (acres)	Area (acres)	Area (acres)	Area (acres)	Area (acres)	Area (acres)	Area (acres)
	Capacity (Ac-ft)	Capacity (Ac-ft)	Capacity (Ac-ft)	Capacity (Ac-ft)	Capacity (Ac-ft)	Capacity (Ac-ft)	Capacity (Ac-ft)	Capacity (Ac-ft)	Capacity (Ac-ft)	Capacity (Ac-ft)	Capacity (Ac-ft)
	0	0.01	0.02	0.03	0.04	0.05	0.06	0.07	0.08	0.09	
110	20,162	20,165	20,168	20,171	20,174	20,177	20,180	20,183	20,186	20,189	
	320,637	320,838	321,040	321,242	321,443	321,645	321,847	322,049	322,250	322,452	
110.1	20,192	20,195	20,198	20,201	20,204	20,207	20,210	20,213	20,216	20,219	
	322,654	322,856	323,058	323,260	323,462	323,664	323,866	324,068	324,271	324,473	
110.2	20,222	20,225	20,228	20,231	20,234	20,237	20,240	20,243	20,246	20,249	
	324,675	324,877	325,079	325,282	325,484	325,686	325,889	326,091	326,294	326,496	
110.3	20,252	20,255	20,258	20,261	20,264	20,267	20,270	20,273	20,276	20,279	
	326,699	326,901	327,104	327,306	327,509	327,712	327,914	328,117	328,320	328,522	
110.4	20,282	20,285	20,288	20,291	20,294	20,297	20,300	20,303	20,306	20,309	
	328,725	328,928	329,131	329,334	329,537	329,740	329,943	330,146	330,349	330,552	
110.5	20,312	20,315	20,318	20,321	20,324	20,327	20,330	20,333	20,336	20,339	
	330,755	330,958	331,161	331,364	331,568	331,771	331,974	332,178	332,381	332,584	
110.6	20,342	20,345	20,348	20,351	20,354	20,357	20,360	20,363	20,366	20,369	
	332,788	332,991	333,195	333,398	333,602	333,805	334,009	334,212	334,416	334,620	
110.7	20,372	20,375	20,378	20,381	20,384	20,387	20,390	20,393	20,396	20,399	
	334,823	335,027	335,231	335,435	335,638	335,842	336,046	336,250	336,454	336,658	
110.8	20,402	20,405	20,408	20,411	20,414	20,417	20,420	20,423	20,426	20,429	
	336,862	337,066	337,270	337,474	337,678	337,882	338,087	338,291	338,495	338,699	
110.9	20,432	20,435	20,438	20,441	20,444	20,447	20,450	20,453	20,456	20,459	
	338,904	339,108	339,312	339,517	339,721	339,926	340,130	340,335	340,539	340,744	

EXHIBIT A
SUPPLEMENTARY PERTINENT DATA

EXHIBIT A
SUPPLEMENTARY PERTINENT DATA

GENERAL INFORMATION

ITEM	DESCRIPTION OR QUANTITY AND UNITS
Location	Addicks - South Mayde Creek, approximately 1.4 miles upstream from Buffalo Bayou Barker - Buffalo Bayou, approximately 1.2 miles upstream from South Mayde Creek
Type of Project	Detention - Type Reservoir
Objectives of regulation	Primary purpose is flood control
Project owner	U.S. Army Corps of Engineers
Operating agency	U.S. Army Corps of Engineers
Regulating agency	U.S. Army Corps of Engineers
Hydropower	None
Water supply contracts	None
Other formal agreements	None
Water rights	Riparian
Project cost (both dams)	\$4,000,000
Closure Date	Addicks – 08 Jun 1948 Barker – 25 Aug 1945

RESERVOIRS

ITEM	DESCRIPTION OR QUANTITY AND UNITS		
------	-----------------------------------	--	--

Feature	Elevation (ft, NAVD88)	Surface Area (acres)	Storage Capacity (ac-ft)
---------	---------------------------	----------------------------	--------------------------------

ADDICKS RESERVOIR

Conduit Invert	66.0	7	35
Limits of Government Land	103.0	13,016	127,591
100-Year Flood	103.8	13,405	138,687
Standard Project Flood	107.6	15,886	193,956
Natural Ground at End of Dam	108.0	16,199	199,643
Top of Dam	121.0		-

BARKER RESERVOIR

Conduit Invert	68.5	0	0
Limits of Government Land	95.0	12,036	82,921
100-Year Flood (1)	97.0	12,574	107,363
Standard Project Flood	98.3	13,412	125,061
Natural Ground at End of Dam	104.0	16,543	209,600
Top of Dam	113.1		-

Length of embankment	Addicks - 61,166 feet Barker - 71,900 feet
Initial real estate taking	Addicks - 12,460 acres Barker - 12,060 acres
Range of clearing	Not applicable

(1) Provisional until compliant with the USACE Civil Works Review Policy

HYDROLOGY

ITEM	DESCRIPTION OR QUANTITY AND UNITS
Drainage area (total)	Addicks – 136 square miles Barker – 130 square miles
1" runoff equals	Addicks – 7,253 acre-feet Barker – 6,933 acre-feet
Standard Project Flood	Addicks – 193,956 acre-feet Barker – 125,061 acre-feet
Spillway Design Flood	Addicks – 462,145 acre-feet Barker – 279,072 acre-feet
Maximum flood of record	Addicks – 217,896 acre-feet (August 2017) Barker – 170,941 acre-feet (August 2017)
Minimum daily flow	Addicks – 35 cfs Barker – 23 cfs
Average flows	(see Table 4-03)
Hydrometeorologic data	A real-time flood forecasting model was developed by the Hydrologic Engineering Center (HEC). This system is used to predict the inflow into the reservoirs. The forecasting system consists of PRECIP and HEC-HMS models. Both models use a one-hour time interval. Precipitation estimates are available from three main sources: precipitation gages, radar, and satellite.

EMBANKMENTS

ITEM	DESCRIPTION OR QUANTITY AND UNITS
Purpose	To complete impoundment structure to high ground and provide for access road
Type	Overflow and Non-Overflow
Type of Fill	Rolled earth fill, soil-cement protection on overflow sections
Length	Addicks – 61,166 feet Barker – 71,900 feet
Top Elevation	Addicks – 121.0 (non-overflow) Barker – 113.1 (non-overflow)

SPILLWAY

ITEM	DESCRIPTION OR QUANTITY AND UNITS
Location	Two emergency spillways at both ends of the dam for both Addicks and Barker Dams
Type	Uncontrolled weirs
Crest Elevation	Addicks (north end) – 112.5 Addicks (south end) – 115.5 Barker (north end) – 105.5 Barker (south end) – 106.7
Net Overflow Length	Addicks (north end) – 8,400 feet Addicks (south end) – 10,500 feet Barker (north end) – 3,000 feet Barker (south end) – 12,500 feet
Maximum Discharge	PMF analysis underway

SPILLWAY CONTINUED

ITEM	DESCRIPTION OR QUANTITY AND UNITS
Type of Energy Dissipater	Cement apron along emergency spillway
Reoccurrence Interval of Pool Attaining Crest Elevation	Addicks – exceeds 500-year event Barker – exceeds 500-year event
Spillway Activation	None to date (1947-2019)

OUTLET FACILITIES

ITEM	DESCRIPTION OR QUANTITY AND UNITS
Location	Addicks – Main Channel of South Mayde Creek Barker – Main Channel of Buffalo Bayou
Type	Addicks – gated steel-lined conduits Barker – gated steel-lined conduits
Number and Size of Conduits	Addicks – 3 10-foot diameter conduits encased in concrete Barker – 3 12-foot diameter conduits encased in concrete
Length of Conduits	Addicks – 247.67 feet Barker – 131.92 feet
Upstream Invert Elevation	Addicks – 66.0 feet Barker – 68.5 feet
Energy Dissipator	Addicks – 59 foot parabolic chute spillway and 55 foot long, 54 foot wide longitudinal stilling basin with baffle blocks and end sill Barker – 50 foot parabolic chute spillway and 51 foot long, 57 foot wide longitudinal stilling basin with baffle blocks and end sill

HYDROELECTRIC POWER FACILITIES

None

LOCK

None

CONTROL STATION

<u>ITEM</u>	<u>DESCRIPTION OR QUANTITY AND UNITS</u>
Location	Buffalo Bayou at Piney Point streamgage approximately 10.2 miles downstream from Barker Dam
Target Flow Rates	2,000 cfs
Monitoring Provisions	The station is equipped with a water stage recorder and a data collection platform for transmission of hourly data via GOES satellite at 4-hour intervals.

EXHIBIT B
POLICY LETTER TO HARRIS COUNTY

SWGED-H

30 December 1981

Honorable Jon Lindsay
County Judge, Harris County
1001 Preston Avenue
Houston, Texas 77002

Dear Judge Lindsay:

This is to advise you of a change in policy relative to drainage improvements or other facilities which affect drainage on Government-owned lands of Addicks and Barker Reservoirs.

Because of serious seepage problems with the reservoir embankments and the incompleteness of our hydrological reevaluation we established a policy relative to drainage improvements in early 1979 which in effect precluded the construction of any further channel improvements within the reservoirs or enlargement of ditches which parallel the downstream side of the embankments.

Although our repair of the embankments and hydrological reevaluation have been completed, there are still some significant problems with the reservoirs. These problems are primarily their inability to safely pass the spillway design flood and the continued compromised gate operation because of the inadequate capacity of Buffalo Bayou downstream of the reservoirs. The inability to safely pass the spillway design flood was discussed in my letter to you of 16 November 1981. Notwithstanding these problems, our previous policy relating to drainage improvement on reservoir lands can be relaxed without significant effect on the operation of the reservoirs.

In view of this, our revised policy relative to drainage improvements or other facilities which effect drainage on Government-owned lands of Addicks and Barker Reservoirs follows:

a. Drainage improvements for Langham, Horsepen and South Mayde Creeks will be considered for ultimate condition flows as presented in Harris County's Comprehensive Study of Drainage for Buffalo Bayou Watershed above Addicks and Barker Dams, dated June 1980.

30 December 1981

b. Drainage improvements for Turkey, Bear and Mason Creeks and the reach of Buffalo Bayou above the Barker Reservoir will be considered to the extent where these streams can carry the rainfall runoff up to and including the 100-year frequency storm for watershed conditions existing as of 1 January 1979. (The 1 January 1979 was selected to be consistent with Harris County's Comprehensive Study of Drainage for Buffalo Bayou Watershed above Addicks and Barker Dams, dated June 1980.) Drainage improvements of other minor channels or laterals will be considered on the basis of the same criteria.

c. The current policy of precluding drainage improvements into the Barker and Clodine ditches and laterals thereto which would increase runoff rates into Buffalo Bayou will continue in effect.

Drainage improvements to the streams identified above or construction of any facilities which affect drainage will be subject to the following conditions:

a. Applications for such easements must be made by the appropriate governmental entity (Harris County Flood Control District) as opposed to municipal utility districts or individual developers. This will assure that we always have a viable agency to deal with concerning future compliance with terms and conditions of any easements or licenses that may be issued. Although any easement granted will be specifically defined and limited, we want to stress that future maintenance of facilities approved will be strictly limited to the original dimensions and alignment. Future modifications, if any, may not require a new easement but such modifications will have to be approved in writing by the Galveston District. Any proposed action must be consistent with the approved Master Plan for Addicks and Barker Reservoirs. The approved Master Plan will always consider the broad scope of the total proposed project and its effect on the resources of the general public, both above and below the reservoirs. Therefore, all outgrants must be considered to be in the best interest of the overall general public, as opposed to serving only the financial interests of private developers.

b. Design criteria for drainage improvements will be consistent with Harris County's Comprehensive Study of Drainage for Buffalo Bayou Watershed above Addicks and Barker Dams of June 1980. It will be the applicant's responsibility to provide supportive technical data for proposed improvements to insure compatibility with the District policy. Applications without the appropriate supporting technical data will not be considered.

30 December 1981

- c. Drainage improvements of stream or laterals will be limited to a maximum of 1.5 miles within the reservoir lands. Drainage improvements on streams or laterals which significantly disturb the aesthetic or natural environment of the streams will not be permitted. However, in such cases adequately designed and construction diversions will be considered as viable alternatives.
- d. The applicant will provide and maintain settling basins or alternative control methods on inflowing streams to reduce velocity and essentially preclude permanent deposition of sediment in the federally-owned reservoir lands.
- e. A diligent maintenance program consistent with Corps of Engineers' standards will be required for each approved feature.
- f. The applicant will be required to furnish an Environmental Assessment (EA) to assist the Galveston District in determining the effects of the proposed action on significant resources. The EA will include a brief discussion of the need for the proposed action, its environmental impacts, alternatives to the proposed action, and mitigating measures, if any, for the proposed action. The document will be supported by necessary appendices or technical data and will be concise for meaningful review before any action will be approved.
- g. Easements will be compatible with Corps of Engineers' operation and maintenance activities and with other uses and functions of the reservoirs and will not unduly interfere with any other licensed, leased or permitted activity. Preservation of the recreation, wildlife, vegetation, water and cultural resources of Addicks and Barker Reservoirs will be a primary consideration in approval of the easements.
- h. The applicant should have easements in his possession and written approval of detail plans and specifications from the Galveston District for each approved feature prior to advertising for construction.
- i. Completed roadways within the reservoir will be marked with prominent signs stating that the roadway is subject to inundation.
- j. The necessity for Department of the Army permits will be determined on each application.

SWGED-H
Honorable Jon Lindsay

30 December 1981

k. The applicant will be required to indemnify the Government from any and all claims for damages to persons or property that may result from construction and subsequent maintenance of the improvements.

If you or your representative want to discuss this policy further, we will arrange a meeting at your convenience.

Sincerely,

JAMES H. SIGLER
Colonel, Corps of Engineers
District Engineer

Copies furnished:

Commissioner Tom Bass, Prec. No. 1

Commissioner James Fonteno, Prec. No. 2

Commissioner Bob Eckels, Prec. No. 3

Commissioner E. A. Lyons, Jr., Prec. No. 4

Mr. Richard Doss
County Engineer, Harris County
7th Floor, Harris County Admin Bldg
1001 Preston Avenue
Houston, TX 77002

Mr. James Green
Director, Harris County Flood
Control District
8615 N. Main
Houston, TX 77022

EXHIBIT C
STANDING INSTRUCTIONS TO DAMTENDER

EXHIBIT C
STANDING INSTRUCTION TO DAMTENDER

ADDICKS AND BARKER RESERVOIRS, BUFFALO BAYOU, TEXAS

1. Responsibility the Operations Division, through the Chief of Project Operations Branch, is responsible for the maintenance and operation of the Addicks and Barker Reservoirs. The Engineering and Construction Division, who is also designated as the Dam Safety Officer (DSO), through the Water Management Section/H&H Branch Sub-Section is responsible for the preparation and issuance of the reservoir regulation instructions. The Natural Resource Management Specialist or alternate member of the field office organization will serve as Damtender for both reservoirs. The responsibility of the Damtender is to insure that discharges from the reservoirs are as instructed by the District Hydrologist or in accordance with the plan of regulation set forth in Chapter VII of the Reservoir Regulation Manual. The principle duties of the Damtender are given in section 7-04 of the Water Control Manual and in the supplemental manual "Initial and Emergency Instructions to Damtender." The following instructions for the regulation of the reservoirs will be observed by the Damtender.

2. **INSTRUCTIONS** The Natural Resource Management Specialist will act as the Damtender for reservoir operations. Detailed instructions to the Damtender for Addicks and Barker Reservoirs are presented below.

a. **OPERATION** During flood periods, the reservoir will be operated in accordance with the normal regulation for flood control as described in Chapter VII of the Addicks and Barker Reservoir Regulation Manual or Paragraph 3, 4 or 5 of this exhibit. Instructions for the storage and discharge of flood waters will be issued by the Water Management Section/H&H Branch. In the event that communication with the Galveston District Office is disrupted, the reservoir will be regulated in accordance with the schedule of emergency regulation for flood control (see Chapter VII of the Addicks and Barker Reservoir Regulation Manual or Paragraph 3, 4 or 5 of this exhibit). In addition, the Damtender will make every effort to re-establish communications with the Galveston District Office.

b. **REPORTS TO DISTRICT OFFICE** The Damtender is to observe and be cognizant of all available hydrologic/meteorological data and project activities that are pertinent to the operation of the projects. These data, when requested by the Water Management Section/H&H Branch, will be reported by e-mail, telephone or radio.

3. NORMAL OPERATION

a. Normal conditions – Set two conduit gates at each outlet works at an opening of 1.0 foot each, allowing for the passage of normal low flows.

b. If 1 inch of rainfall, in 24 hours or less occurs, over the watershed downstream of the reservoirs or when flooding is predicted downstream, the Water Management Section/H&H Branch will be contacted. If an unwarranted delay will ensue, the Damtender will proceed to the reservoir, close the gates, and then contact the Water Management Section/H&H Branch.

c. When releases are being made and one-half inch of rainfall, in 24 hours or less, occurs over the watershed downstream of the reservoirs or when flooding is predicted downstream, the Water Management Section/H&H Branch will be contacted. If an unwarranted delay will ensue, the Damtender will proceed to the reservoirs, close the gates, and then contact the Water Management Section/H&H Branch.

4. INDUCED SURCHARGE REGULATION

a. Induced Surcharge conditions at Addicks and Barker Reservoirs are defined to exist at any time the reservoir pool equals or exceeds 101 feet NAVD88 at Addicks (about 45 percent of storage) and 95.7 feet NAVD88 at Barker (about 40 percent of storage) on the reservoir gages. If inflow and pool elevation conditions dictate the use of the induced surcharge regulation schedule, the Water Management Section/H&H Branch will be contacted and instructions will be provided. Advance information will be given the public by the District Engineer or in his absence by the Officer-in-Charge through the media of the U.S. National Weather Service, other agencies, telephone, radio, television, and newspapers.

b. Emergency Conditions (Loss of Communications). If the Water Management Section/H&H Branch cannot be contacted and communications are lost, emergency conditions exist. Releases will be made independently by the Damtender in accordance with the induced surcharge regulation schedules shown on Plates 7-03 and 7-04. Using the horizontal curve that corresponds to the appropriate rate-of-rise, locate the pool elevation that the reservoir is currently at, on the vertical axis. The corresponding surcharge release rate is read from the horizontal axis. The bold vertical lines provide recommended gate openings to achieve the requisite surcharge release rates. If inflow and pool elevation conditions dictate the use of the induced surcharge regulation schedule in either reservoir, releases will be made regardless of channel capacity downstream. Every effort should be made to provide advance information to the public by the Damtender or in his absence by the alternate through the media of the U.S. National Weather Service, Civil Defense, radio, television and newspapers. The

gates should remain at the maximum opening attained from the induced surcharge operation schedules until reservoir levels fall to elevation 101 feet NAVD88 in Addicks and 94.9 feet NAVD88 in Barker. Then, if the out-flow from both reservoirs when combined with the uncontrolled runoff downstream is greater than channel capacity, adjust the gates until the total discharges do not exceed channel capacity and follow the normal operating procedures in section 7-05, paragraph a, sub-section 4 of the Addicks and Barker Water Control Manual.

PLATES



Legend

- Addicks Reservoir
- Barker Reservoir

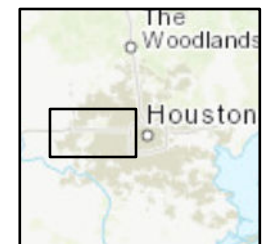

**Vicinity Map
Addicks and Barker Reservoirs**

Plate 2-01

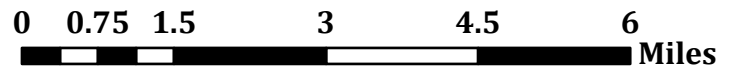

The data is only a representation of features on the earth completed by a computer program from raw data obtained from different sources and is not necessarily, in whole or in part, based upon any physical recording, study or survey, professional or otherwise, of the covered property. This information is not intended as a substitute for a field survey by a professional or any other use or application that requires legal or engineering accuracy.



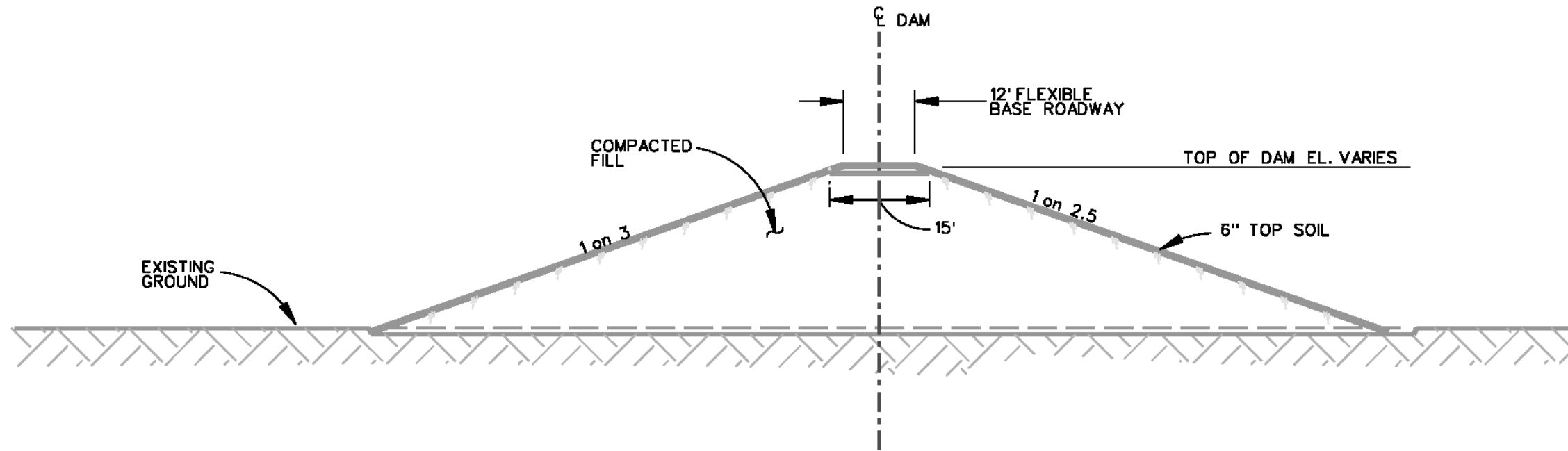

TYPICAL SECTION - DAM
N.T.S.

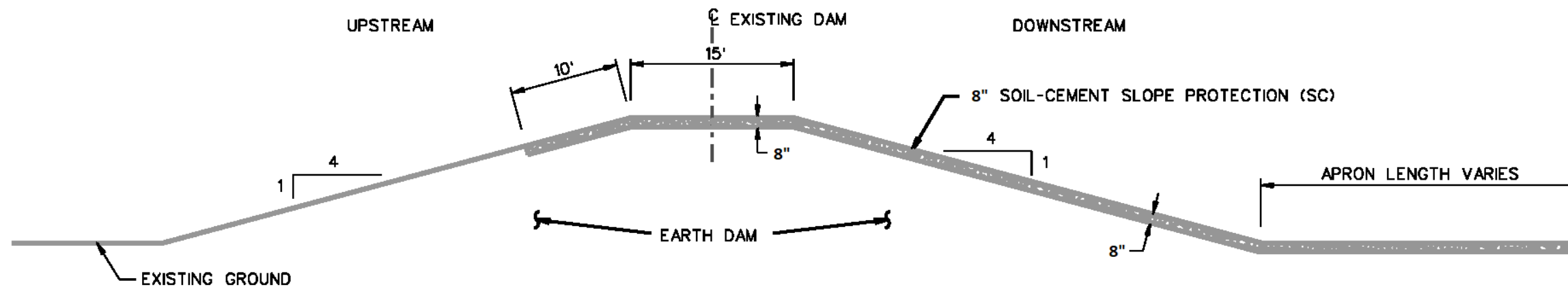

TYPICAL SECTION - SPILLWAY
N.T.S.

8 Ua 'UbX'Gd]'k UmHnd]WU'GYW]cbg
5 XX]W_g'FYgYf j c]f

The data is only a representation of features on the earth completed by a computer program from raw data obtained from different sources and is not necessarily, in whole or in part, based upon any physical recording, study or survey, professional or otherwise, of the covered property. This information is not intended as a substitute for a field survey by a professional or any other use or application that requires legal or engineering accuracy.



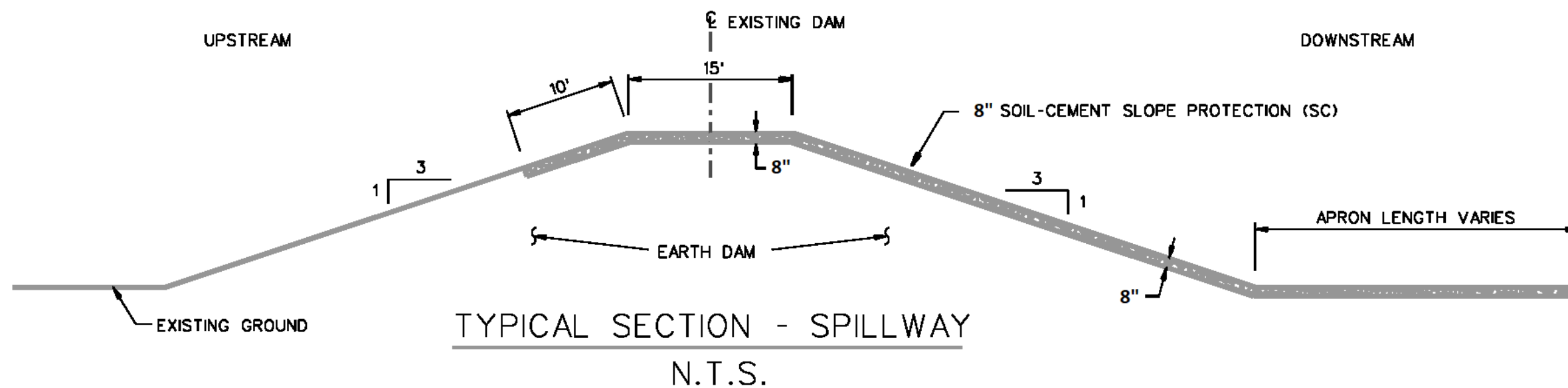
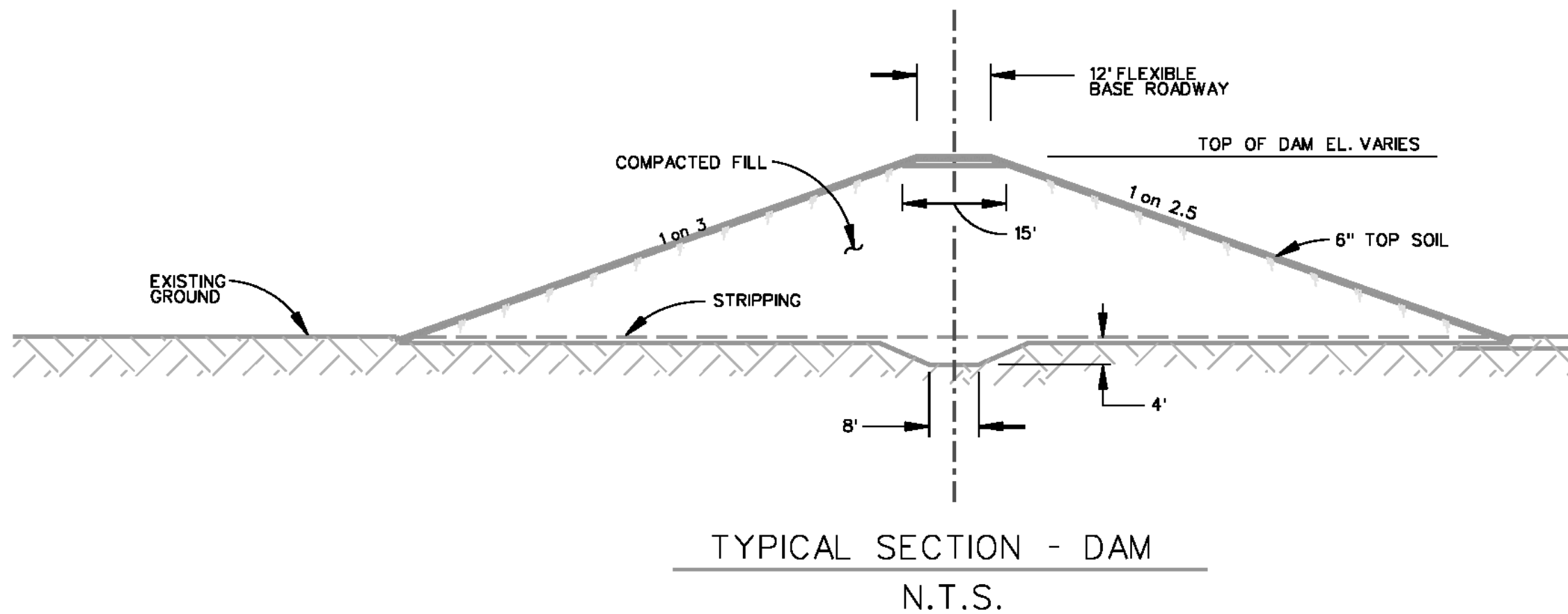

8 Ua 'UbX'Gd]'k UmHnd]WU'GYW]cbg
6 Uf_Yf'FYgYfj c]f

Plate 2-03

The data is only a representation of features on the earth completed by a computer program from raw data obtained from different sources and is not necessarily, in whole or in part, based upon any physical recording, study or survey, professional or otherwise, of the covered property. This information is not intended as a substitute for a field survey by a professional or any other use or application that requires legal or engineering accuracy.



US Army Corps
of Engineers®
Galveston District

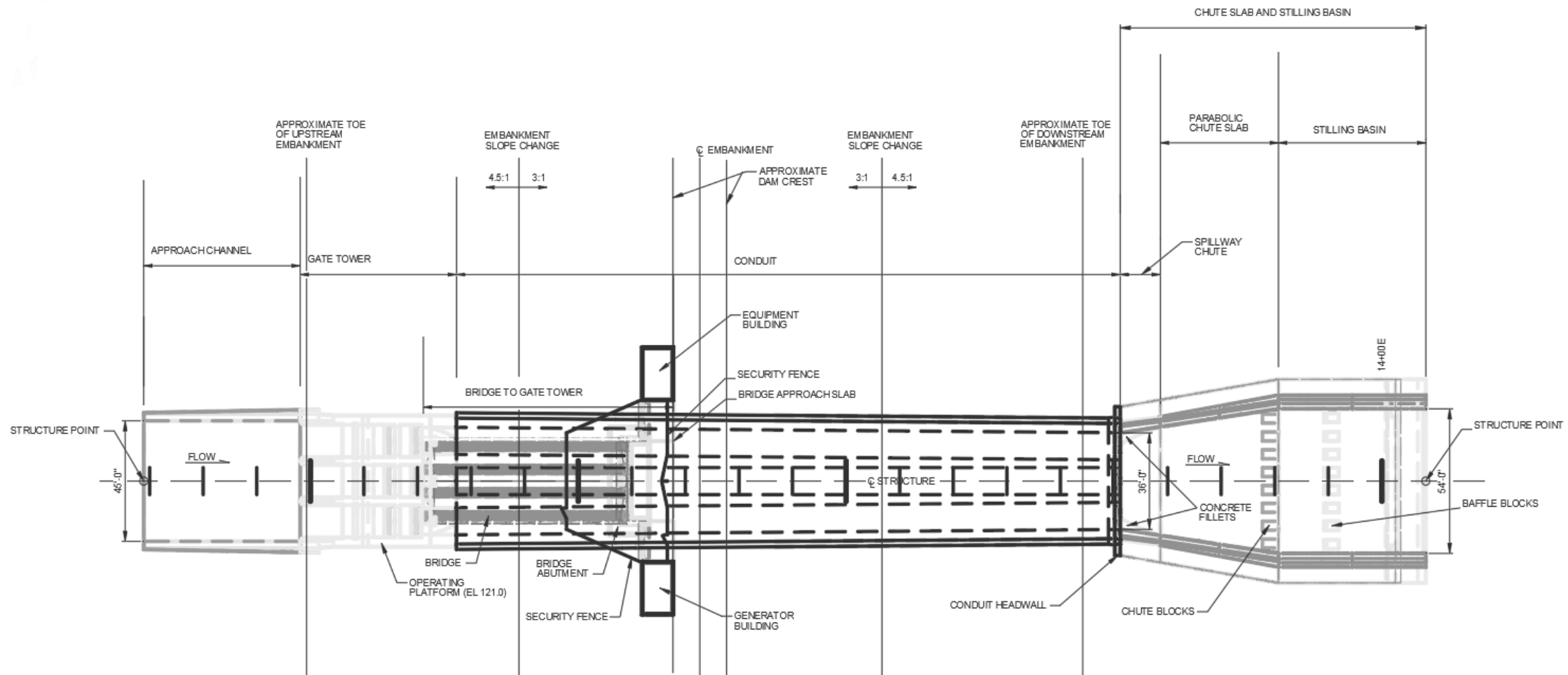

Structural Feature Plan

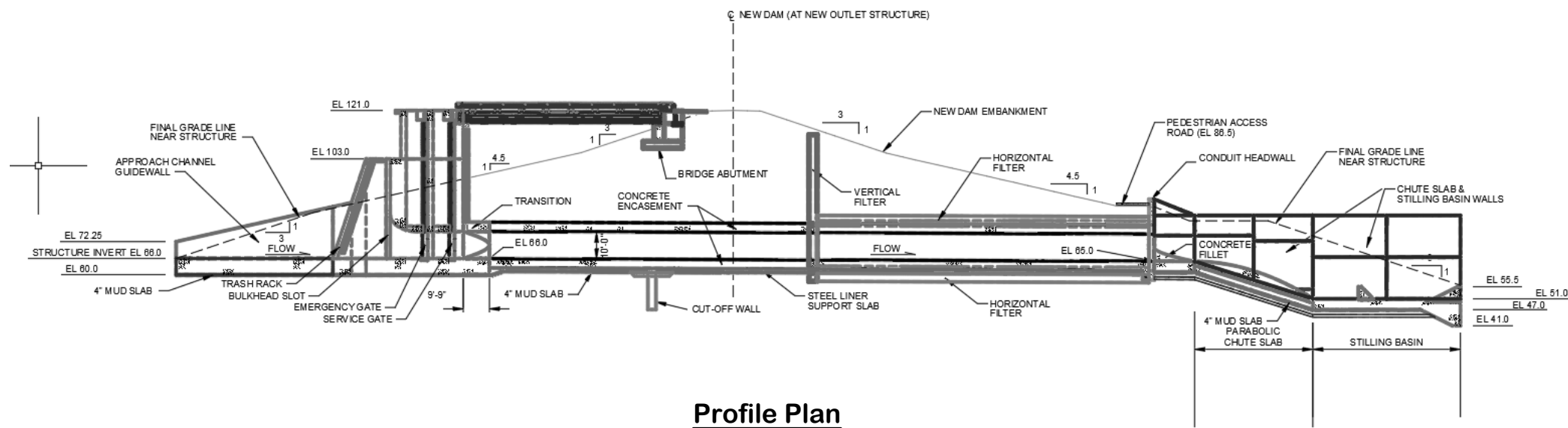

Profile Plan

Ci hYhK cf_g'D'Ub'UbX'DfcZ'Y
5 XX]W_g'FYgYf j c]f

Plate 2-04

The data is only a representation of features on the earth completed by a computer program from raw data obtained from different sources and is not necessarily, in whole or in part, based upon any physical recording, study or survey, professional or otherwise, of the covered property. This information is not intended as a substitute for a field survey by a professional or any other use or application that requires legal or engineering accuracy.



US Army Corps of Engineers
Galveston District

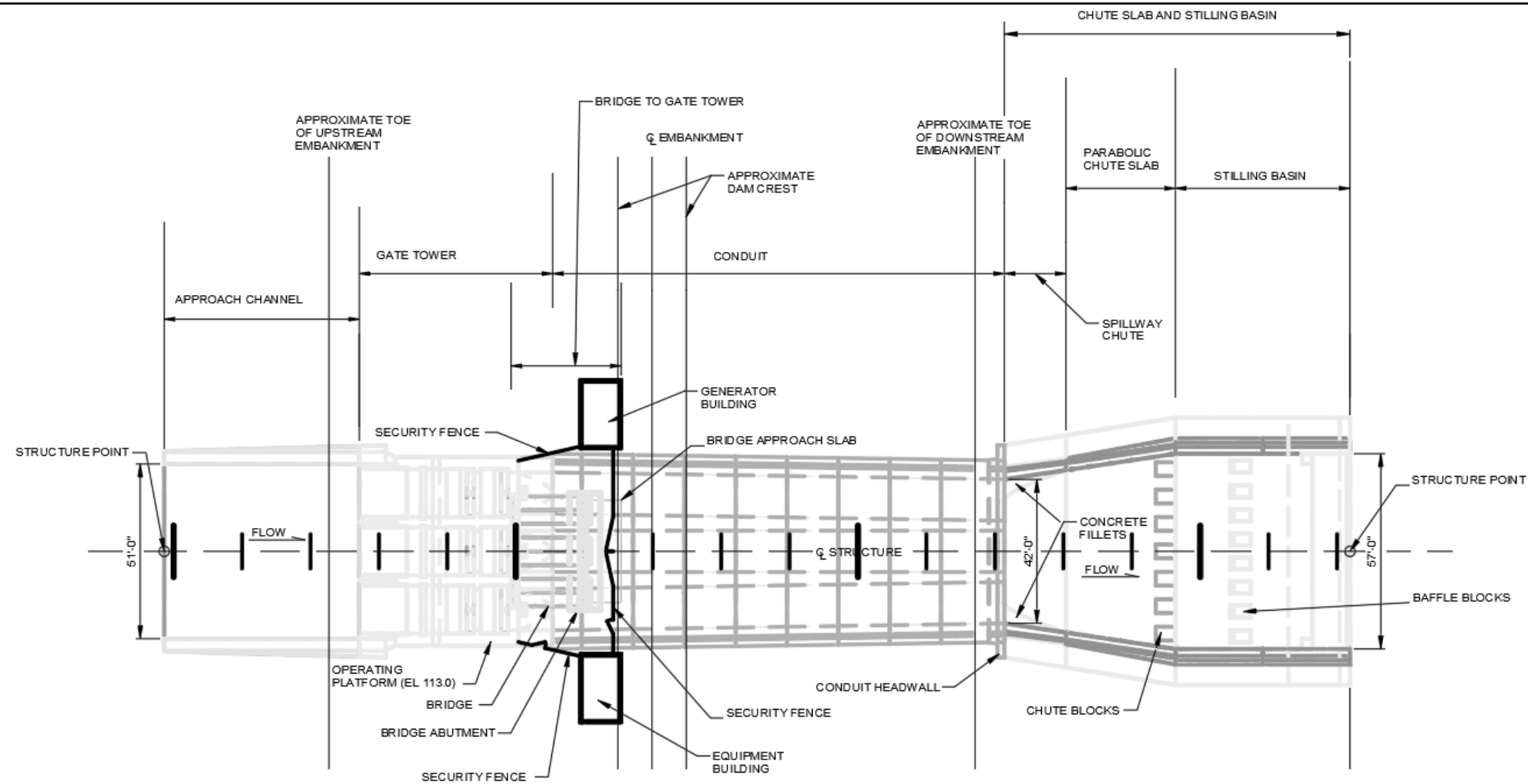

Structural Feature Plan

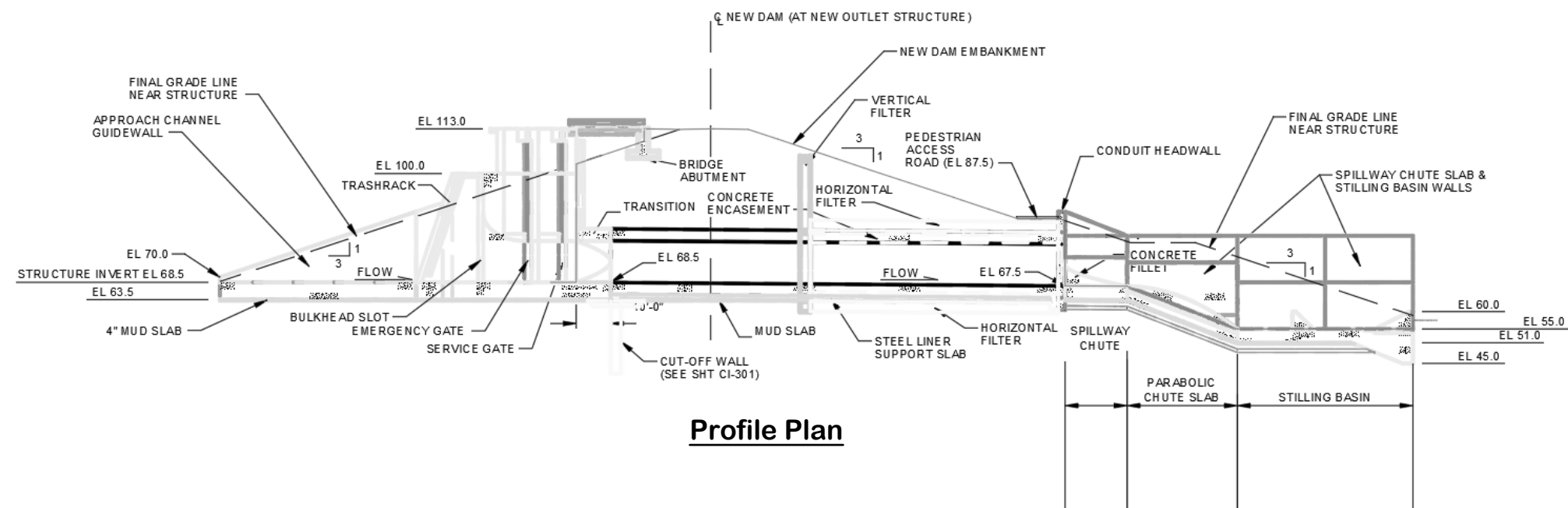

Profile Plan

Ci hYhK cf_g'D`Ub`UbX'DfcZ`Y
6 Uf_Yf`FYgYf j c`f

The data is only a representation of features on the earth completed by a computer program from raw data obtained from different sources and is not necessarily, in whole or in part, based upon any physical recording, study or survey, professional or otherwise, of the covered property. This information is not intended as a substitute for a field survey by a professional or any other use or application that requires legal or engineering accuracy.



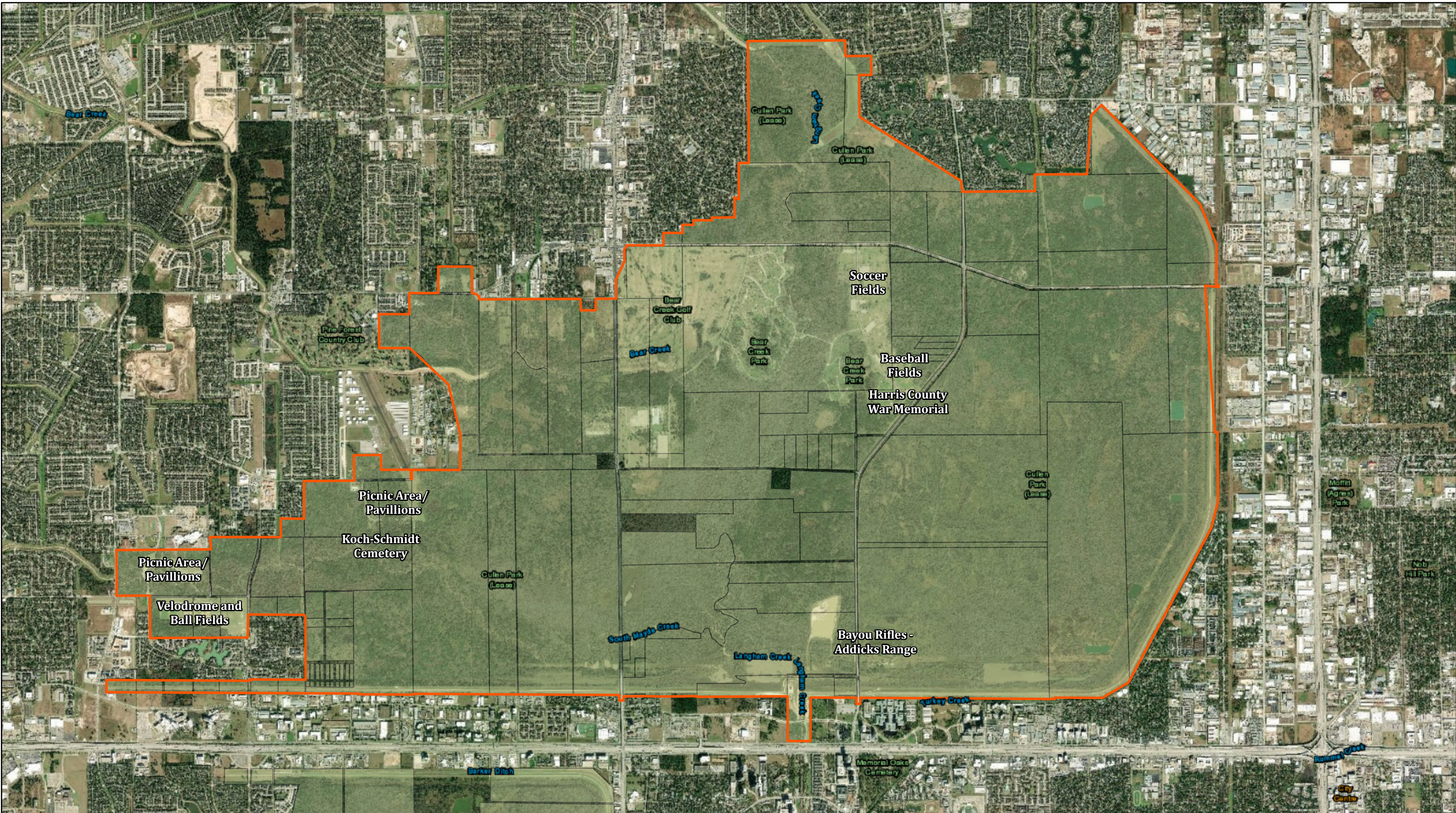

5 XX]W_g'FYgYf j c]f
Di V']W: UW]]H]Yg

Plate 2-06

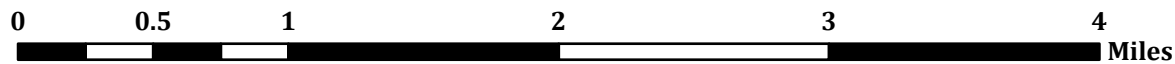

Legend
 Addicks Reservoir



The data is only a representation of features on the earth completed by a computer program from raw data obtained from different sources and is not necessarily, in whole or in part, based upon any physical recording, study or survey, professional or otherwise, of the covered property. This information is not intended as a substitute for a field survey by a professional or any other use or application that requires legal or engineering accuracy.

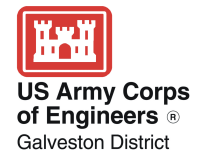



Legend
 Barker Reservoir

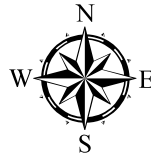

6 Uf_Yf'FYgYf j c]f
 Di V'jW: UW]hYg

Plate 2-07

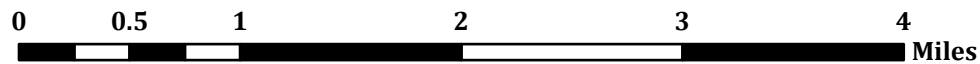

The data is only a representation of features on the earth completed by a computer program from raw data obtained from different sources and is not necessarily, in whole or in part, based upon any physical recording, study or survey, professional or otherwise, of the covered property. This information is not intended as a substitute for a field survey by a professional or any other use or application that requires legal or engineering accuracy.



**Buffalo Bayou
Watersurface Profiles from TSARP HEC-RAS
TSARP Stations 105,000' thru 175,000'**

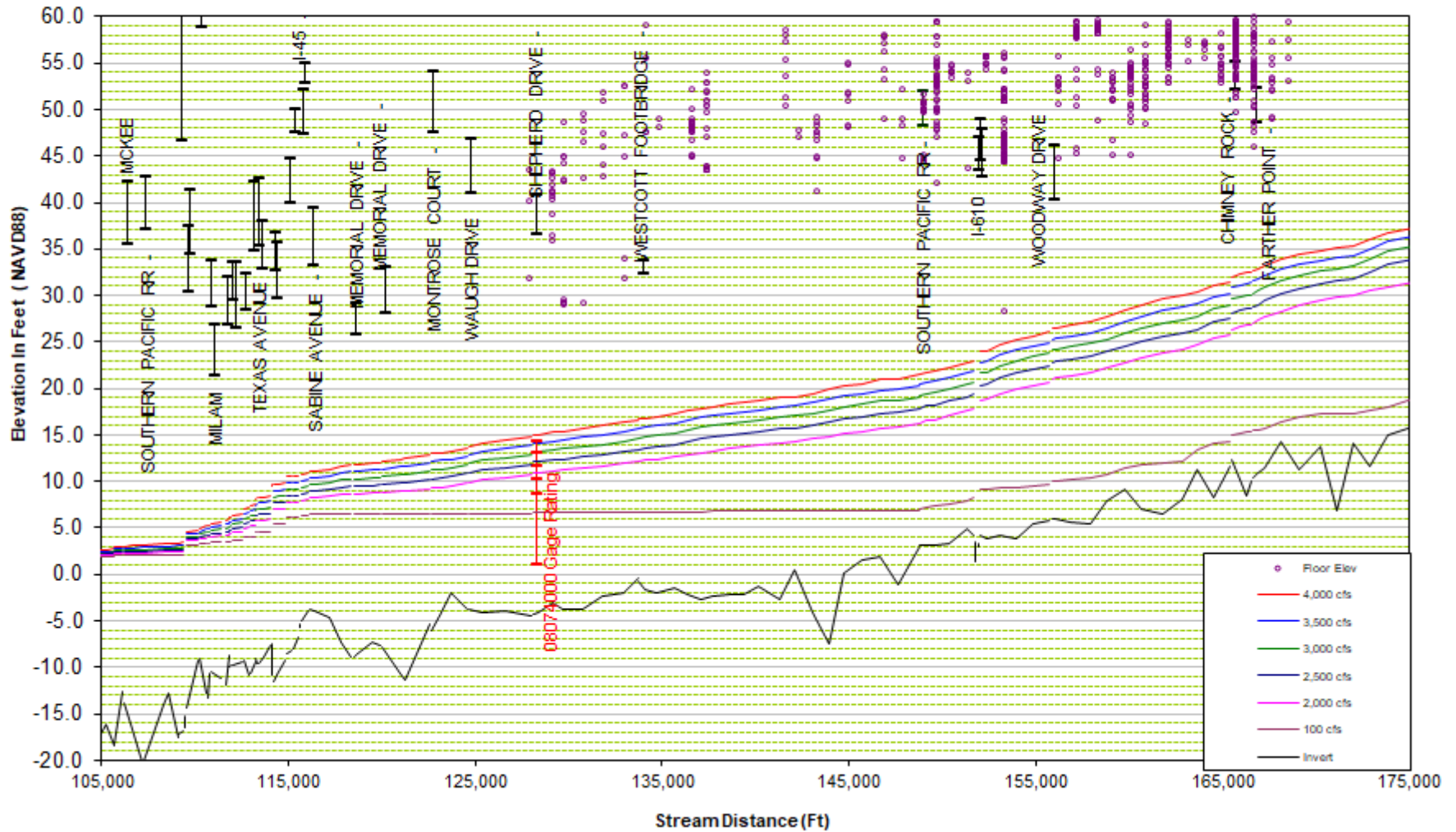

**Water Surface Profiles and Floor Elevations
Buffalo Bayou**

Note: Elevations are NAVD88

**Buffalo Bayou
Watersurface Profiles from TSARP HEC-RAS
TSARP Stations 175,000' thru 250,000'**

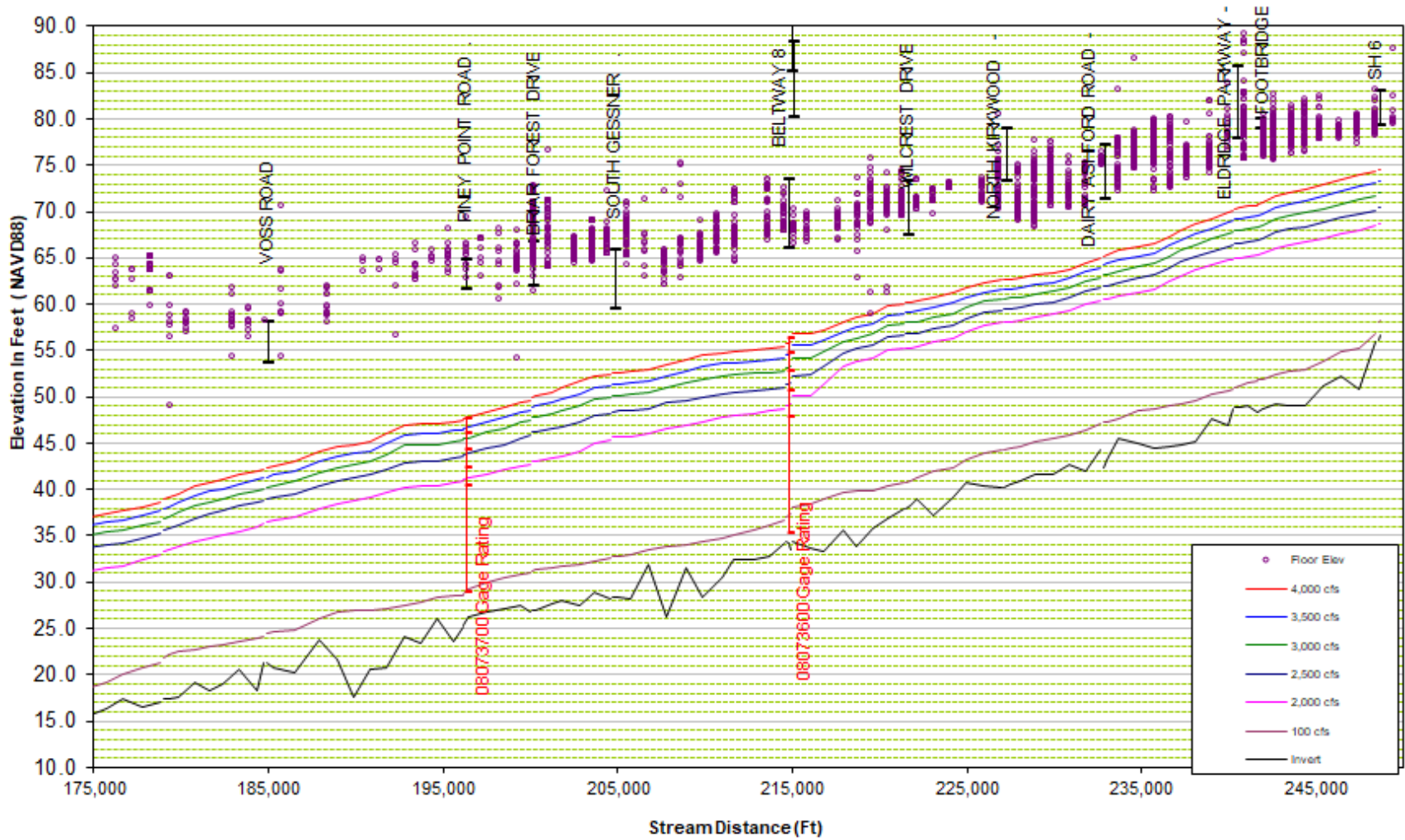

Note: Elevations are NAVD88

**Water Surface Profiles and Floor Elevations
Buffalo Bayou**

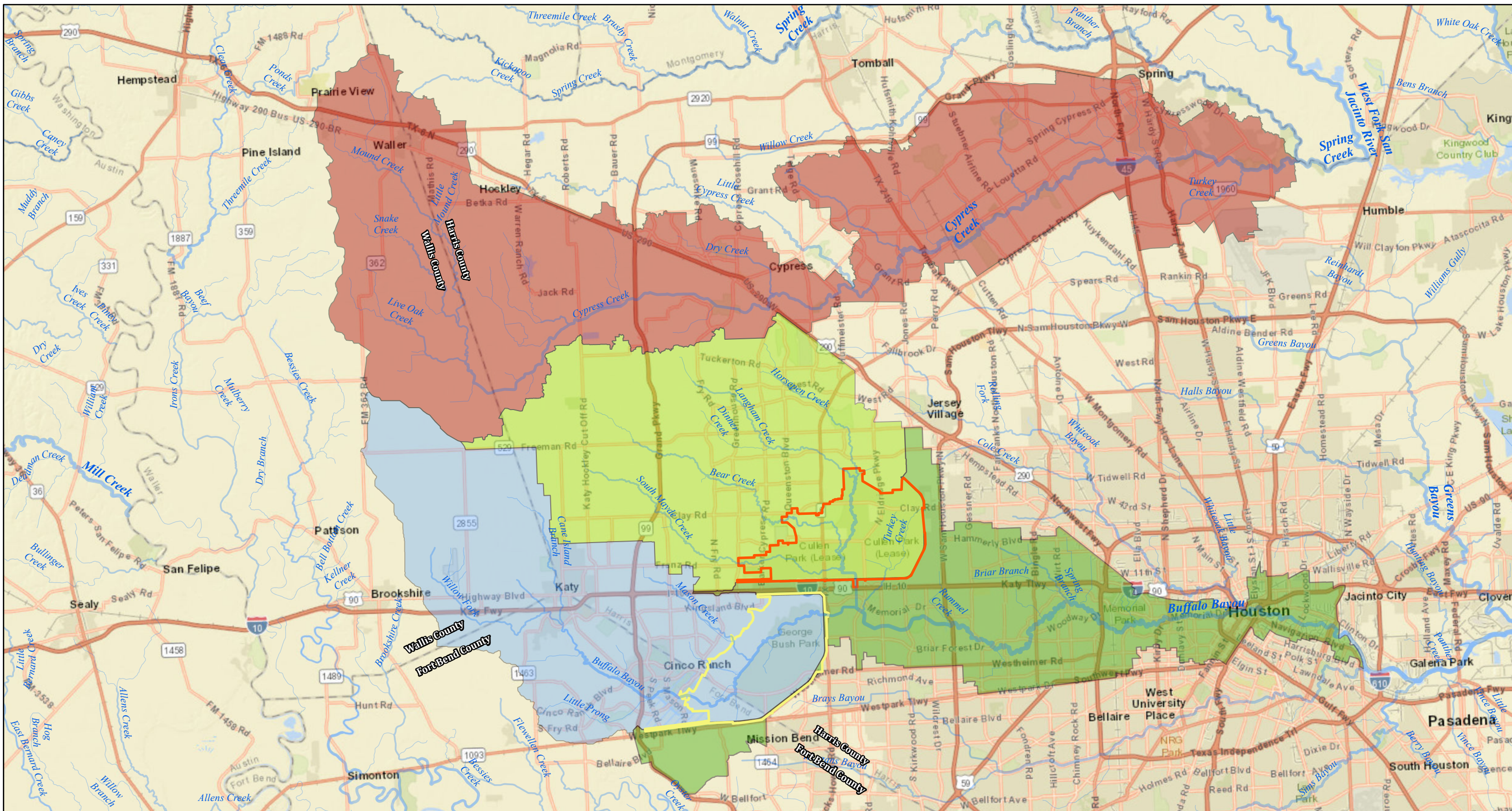

- Legend**
- Addicks Reservoir
 - Barker Reservoir
 - Addicks Watershed
 - Barker Watershed
 - Cypress Creek Watershed
 - Buffalo Bayou Watershed



Drainage Area Map
Addicks, Barker, Cypress Creek, and Buffalo Bayou Watersheds

Plate 4-01

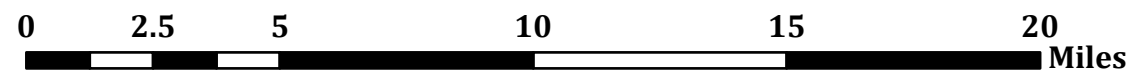

The data is only a representation of features on the earth completed by a computer program from raw data obtained from different sources and is not necessarily, in whole or in part, based upon any physical recording, study or survey, professional or otherwise, of the covered property. This information is not intended as a substitute for a field survey by a professional or any other use or application that requires legal or engineering accuracy.



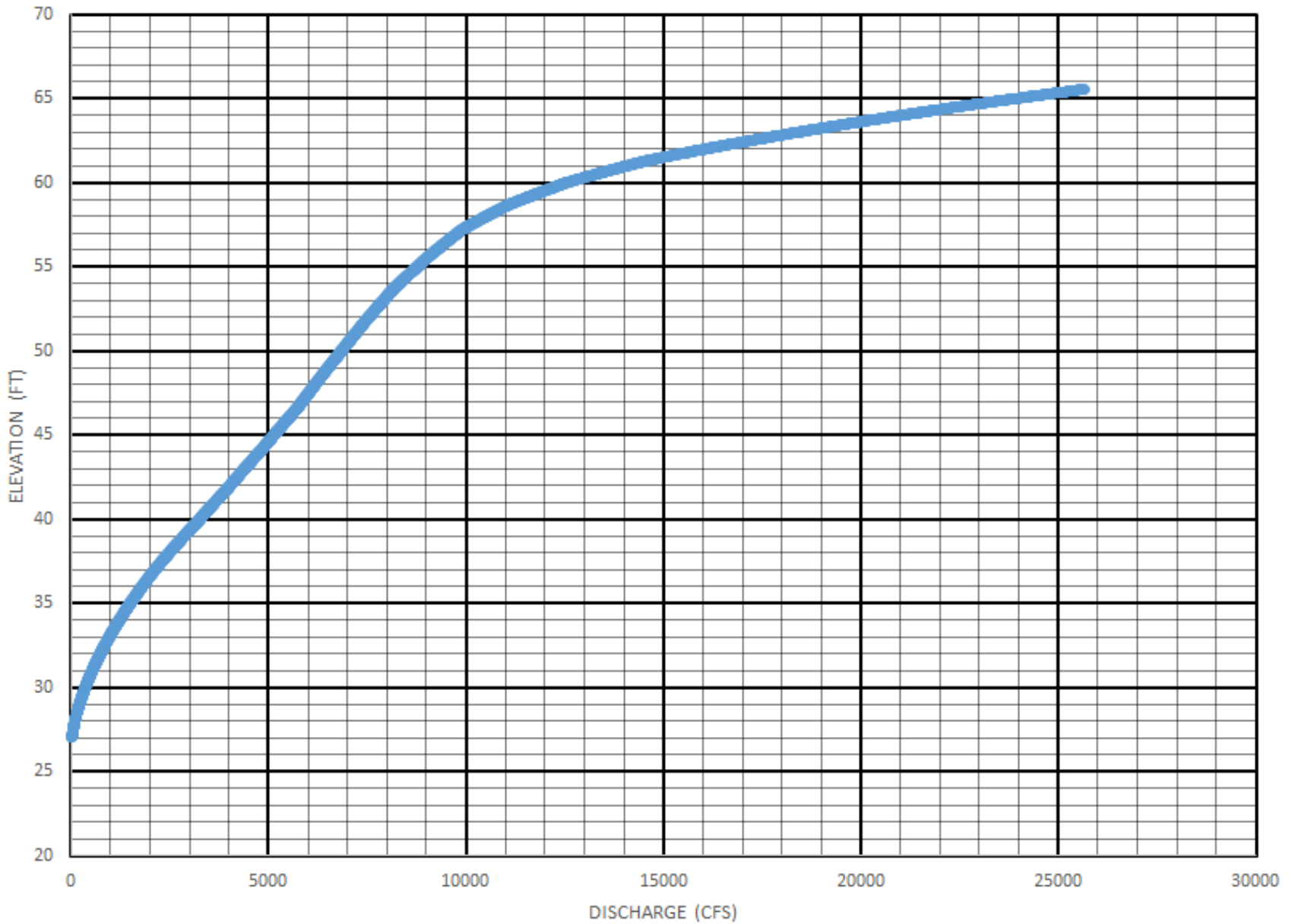

Note: Elevations are NAVD88

Rating curve established 31 October 2018

Discharge Rating Curve Buffalo Bayou at Piney Point

Plate 4-02



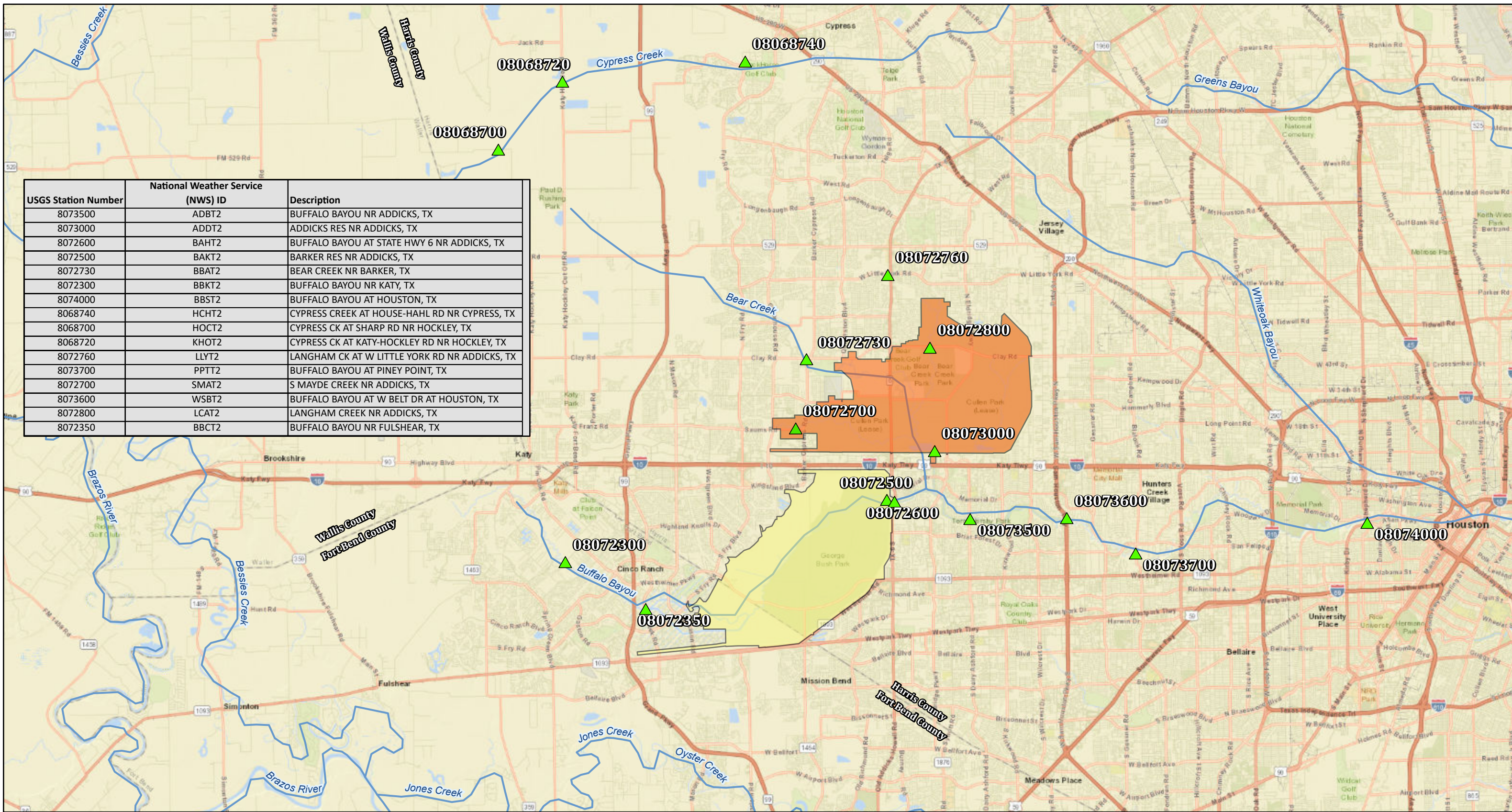

USGS Station Number	National Weather Service (NWS) ID	Description
8073500	ADBT2	BUFFALO BAYOU NR ADDICKS, TX
8073000	ADDT2	ADDICKS RES NR ADDICKS, TX
8072600	BAHT2	BUFFALO BAYOU AT STATE HWY 6 NR ADDICKS, TX
8072500	BAKT2	BARKER RES NR ADDICKS, TX
8072730	BBAT2	BEAR CREEK NR BARKER, TX
8072300	BBKT2	BUFFALO BAYOU NR KATY, TX
8074000	BBST2	BUFFALO BAYOU AT HOUSTON, TX
8068740	HCHT2	CYPRESS CREEK AT HOUSE-HAHL RD NR CYPRESS, TX
8068700	HOCT2	CYPRESS CK AT SHARP RD NR HOCKLEY, TX
8068720	KHOT2	CYPRESS CK AT KATY-HOCKLEY RD NR HOCKLEY, TX
8072760	LLYT2	LANGHAM CK AT W LITTLE YORK RD NR ADDICKS, TX
8073700	PPTT2	BUFFALO BAYOU AT PINEY POINT, TX
8072700	SMAT2	S MAYDE CREEK NR ADDICKS, TX
8073600	WSBT2	BUFFALO BAYOU AT W BELT DR AT HOUSTON, TX
8072800	LCAT2	LANGHAM CREEK NR ADDICKS, TX
8072350	BBCT2	BUFFALO BAYOU NR FULSHEAR, TX

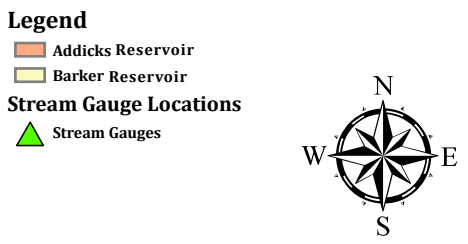

Glf YUa ; Uf [Y' @ WU]cbg
5 XX]W_g'UbX'6 Uf _Yf 'F YgYf j c]fg

Plate 5-01

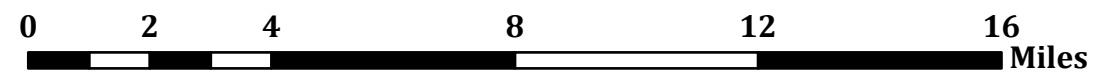

The data is only a representation of features on the earth completed by a computer program from raw data obtained from different sources and is not necessarily, in whole or in part, based upon any physical recording, study or survey, professional or otherwise, of the covered property. This information is not intended as a substitute for a field survey by a professional or any other use or application that requires legal or engineering accuracy.



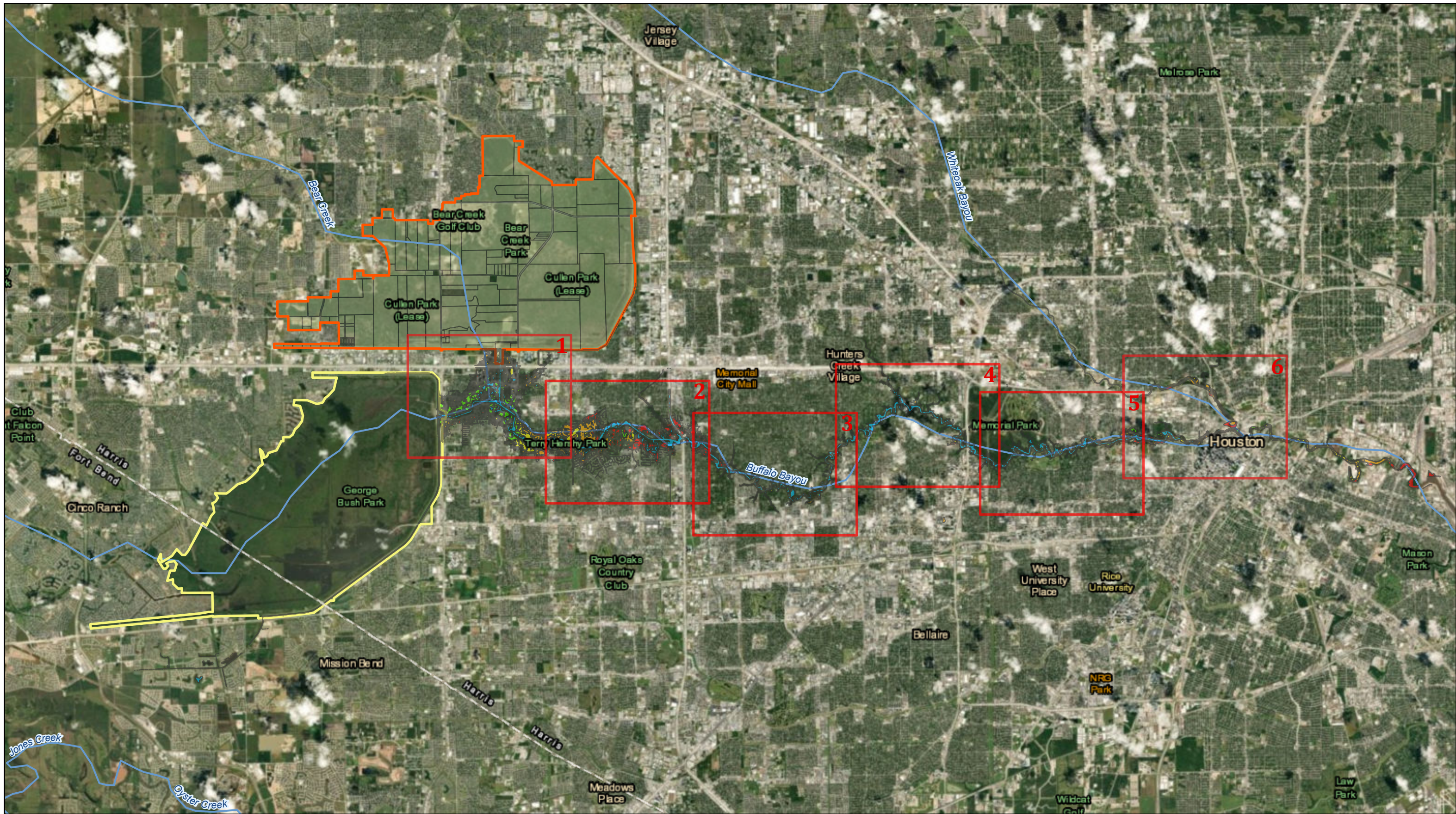

- Legend**
- ▬ Addicks
 - ▬ Barker
- Constant Flow**
- ▬ 3,000 cfs
 - ▬ 6,000 cfs
 - ▬ 10,000 cfs
 - ▬ 15,000 cfs
 - ▬ 20,000 cfs

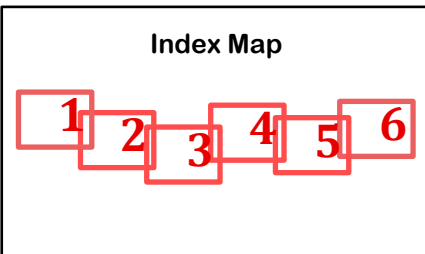

**Constant Flow Inundation Maps
Addicks and Barker Reservoirs
Harris County, Texas
Plate 5-02**

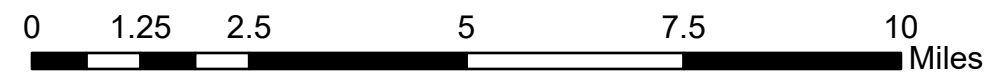

The data is only a representation of features on the earth completed by a computer program from raw data obtained from different sources and is not necessarily, in whole or in part, based upon any physical recording, study or survey, professional or otherwise, of the covered property. This information is not intended as a substitute for a field survey by a professional or any other use or application that requires legal or engineering accuracy.



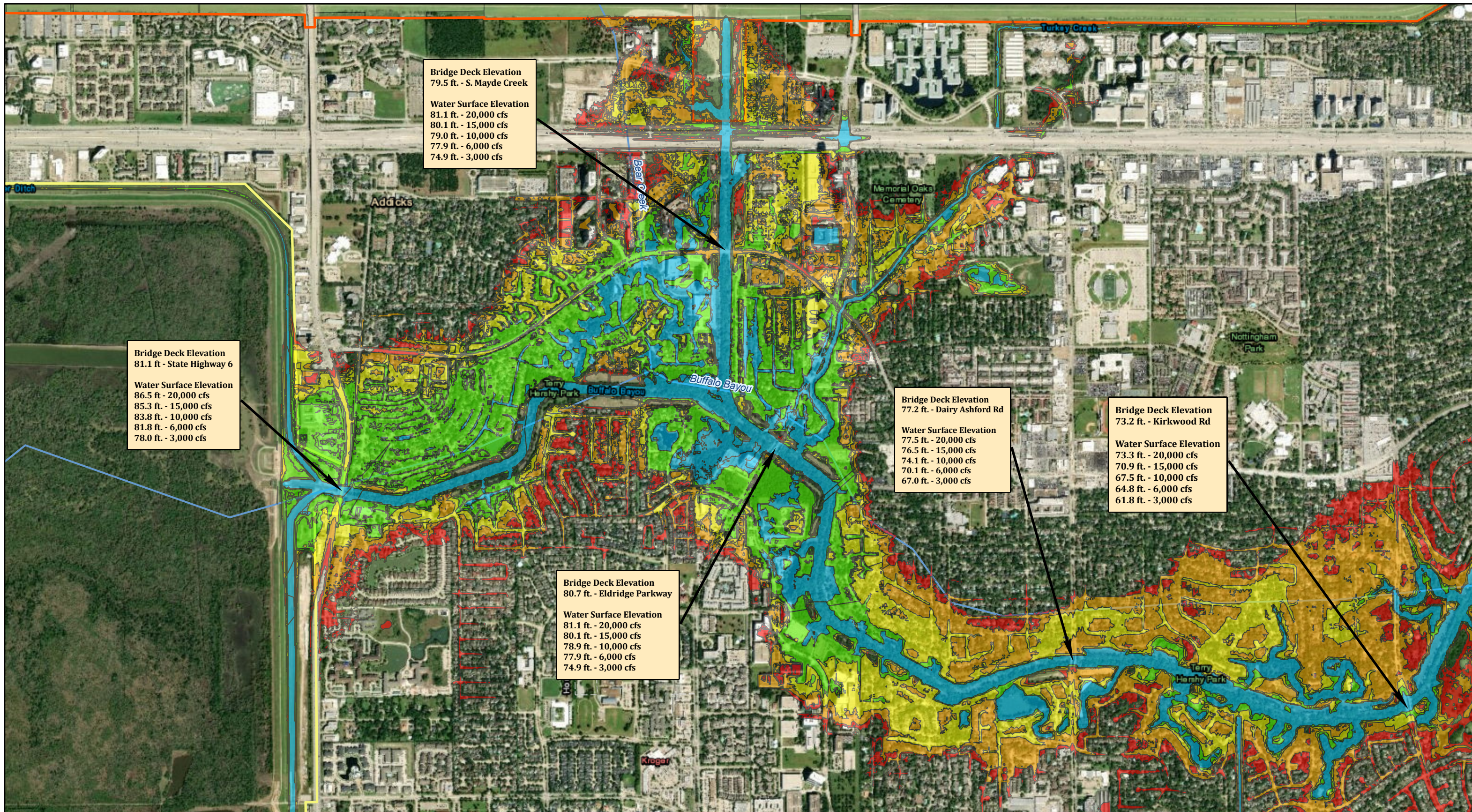

Bridge Deck Elevation
79.5 ft. - S. Mayde Creek

Water Surface Elevation
81.1 ft. - 20,000 cfs
80.1 ft. - 15,000 cfs
79.0 ft. - 10,000 cfs
77.9 ft. - 6,000 cfs
74.9 ft. - 3,000 cfs

Bridge Deck Elevation
81.1 ft. - State Highway 6

Water Surface Elevation
86.5 ft. - 20,000 cfs
85.3 ft. - 15,000 cfs
83.8 ft. - 10,000 cfs
81.8 ft. - 6,000 cfs
78.0 ft. - 3,000 cfs

Bridge Deck Elevation
77.2 ft. - Dairy Ashford Rd

Water Surface Elevation
77.5 ft. - 20,000 cfs
76.5 ft. - 15,000 cfs
74.1 ft. - 10,000 cfs
70.1 ft. - 6,000 cfs
67.0 ft. - 3,000 cfs

Bridge Deck Elevation
73.2 ft. - Kirkwood Rd

Water Surface Elevation
73.3 ft. - 20,000 cfs
70.9 ft. - 15,000 cfs
67.5 ft. - 10,000 cfs
64.8 ft. - 6,000 cfs
61.8 ft. - 3,000 cfs

Bridge Deck Elevation
80.7 ft. - Eldridge Parkway

Water Surface Elevation
81.1 ft. - 20,000 cfs
80.1 ft. - 15,000 cfs
78.9 ft. - 10,000 cfs
77.9 ft. - 6,000 cfs
74.9 ft. - 3,000 cfs

- Legend**
- Constant_Flow**
- 3,000 cfs
 - 6,000 cfs
 - 10,000 cfs
 - 15,000 cfs
 - 20,000 cfs

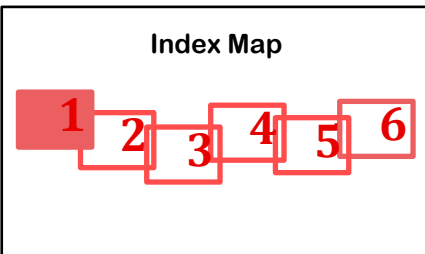

Constant Flow Inundation Map Section 1
Addicks and Barker Reservoirs
Harris County, Texas
Plate 5-03

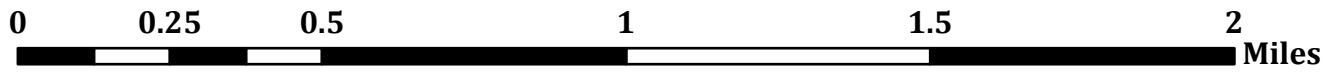

The data is only a representation of features on the earth completed by a computer program from raw data obtained from different sources and is not necessarily, in whole or in part, based upon any physical recording, study or survey, professional or otherwise, of the covered property. This information is not intended as a substitute for a field survey by a professional or any other use or application that requires legal or engineering accuracy.



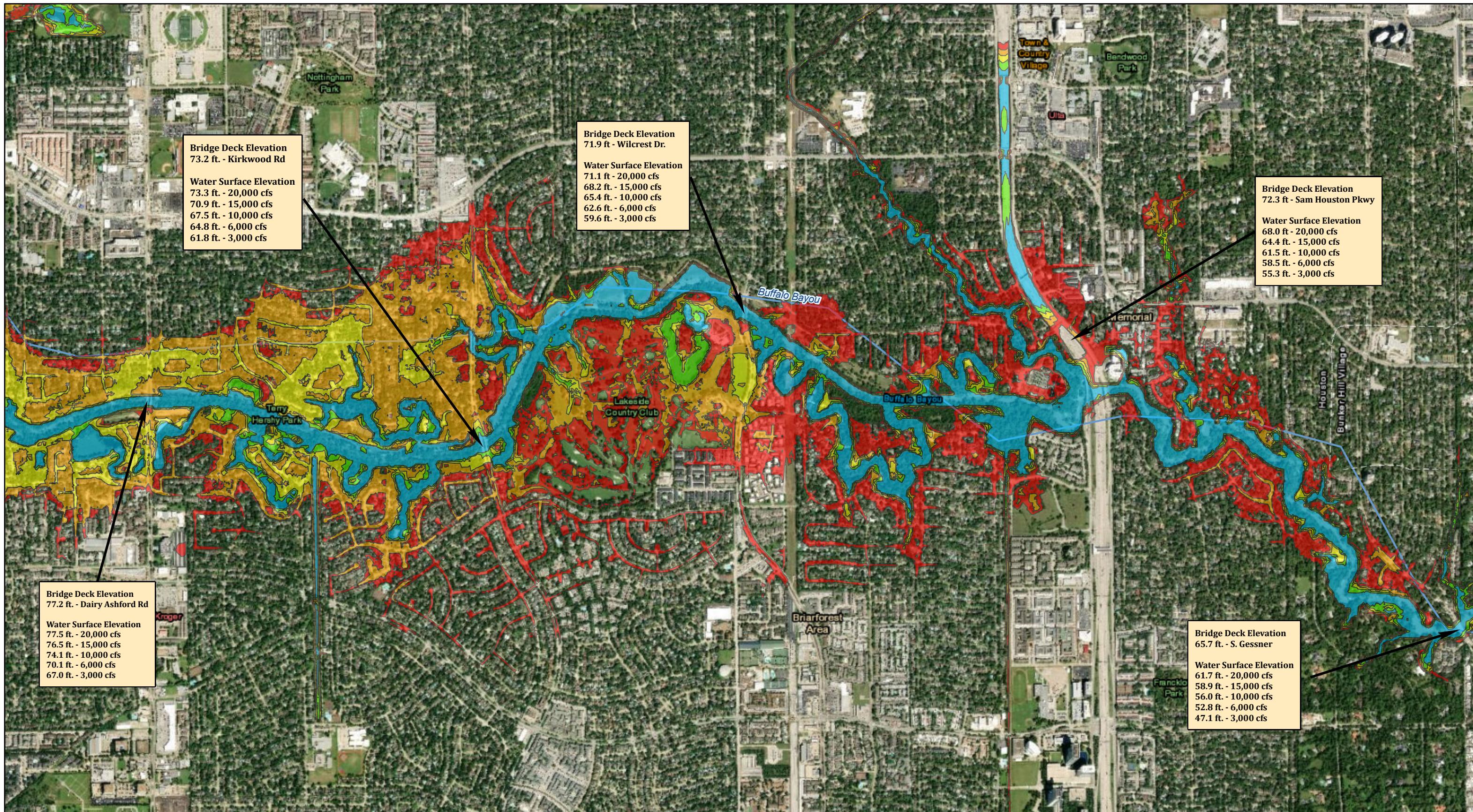

Bridge Deck Elevation
73.2 ft. - Kirkwood Rd

Water Surface Elevation
73.3 ft. - 20,000 cfs
70.9 ft. - 15,000 cfs
67.5 ft. - 10,000 cfs
64.8 ft. - 6,000 cfs
61.8 ft. - 3,000 cfs

Bridge Deck Elevation
71.9 ft. - Wilcrest Dr.

Water Surface Elevation
71.1 ft. - 20,000 cfs
68.2 ft. - 15,000 cfs
65.4 ft. - 10,000 cfs
62.6 ft. - 6,000 cfs
59.6 ft. - 3,000 cfs

Bridge Deck Elevation
72.3 ft. - Sam Houston Pkwy

Water Surface Elevation
68.0 ft. - 20,000 cfs
64.4 ft. - 15,000 cfs
61.5 ft. - 10,000 cfs
58.5 ft. - 6,000 cfs
55.3 ft. - 3,000 cfs

Bridge Deck Elevation
77.2 ft. - Dairy Ashford Rd

Water Surface Elevation
77.5 ft. - 20,000 cfs
76.5 ft. - 15,000 cfs
74.1 ft. - 10,000 cfs
70.1 ft. - 6,000 cfs
67.0 ft. - 3,000 cfs

Bridge Deck Elevation
65.7 ft. - S. Gessner

Water Surface Elevation
61.7 ft. - 20,000 cfs
58.9 ft. - 15,000 cfs
56.0 ft. - 10,000 cfs
52.8 ft. - 6,000 cfs
47.1 ft. - 3,000 cfs

- Legend**
- Constant_Flow**
- 3,000 cfs
 - 6,000 cfs
 - 10,000 cfs
 - 15,000 cfs
 - 20,000 cfs

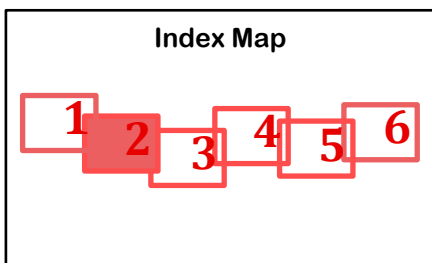

Constant Flow Inundation Map Section 2
Addicks and Barker Reservoirs
Harris County, Texas
Plate 5-04

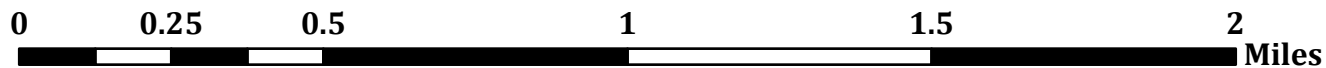

The data is only a representation of features on the earth completed by a computer program from raw data obtained from different sources and is not necessarily, in whole or in part, based upon any physical recording, study or survey, professional or otherwise, of the covered property. This information is not intended as a substitute for a field survey by a professional or any other use or application that requires legal or engineering accuracy.



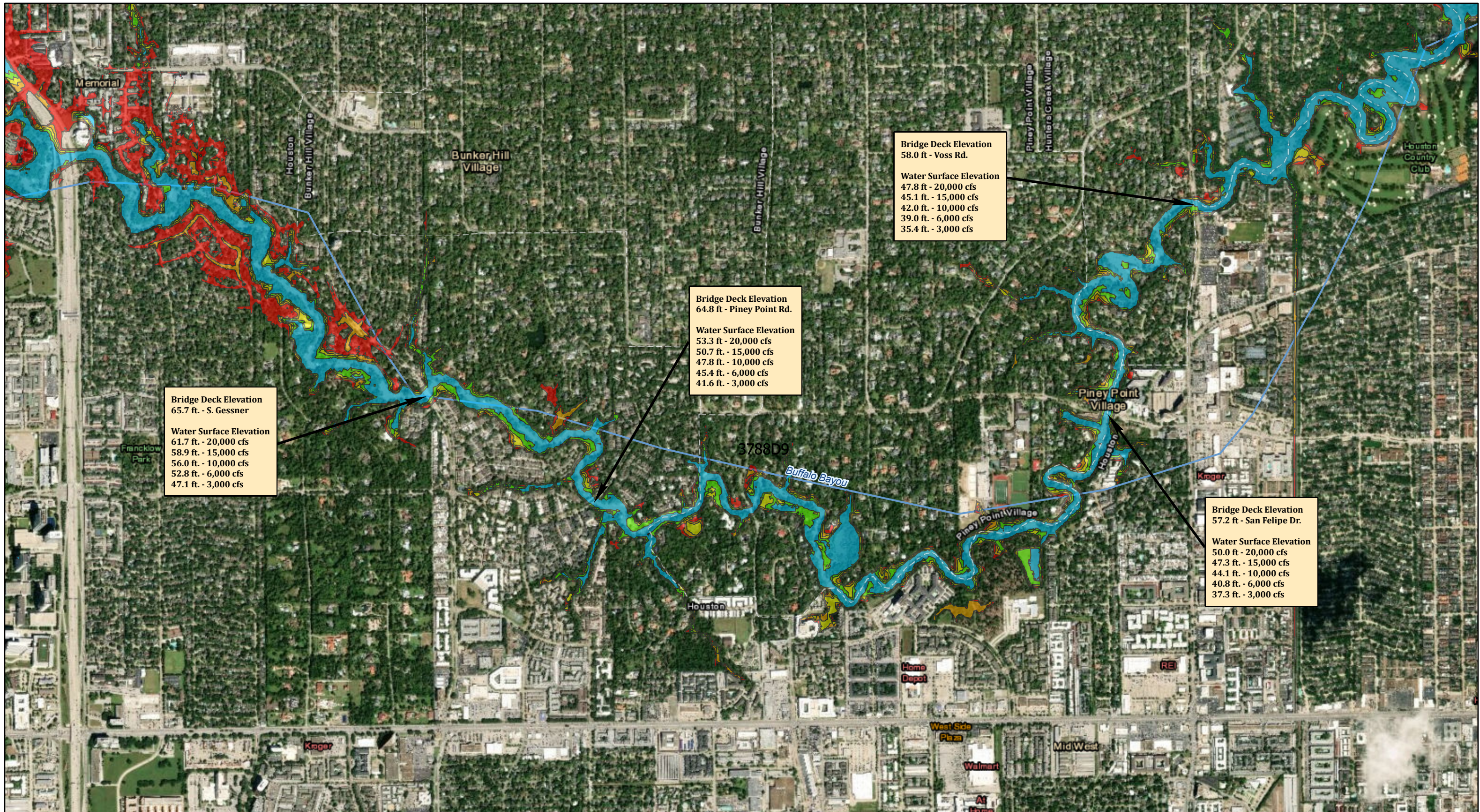

Bridge Deck Elevation
65.7 ft. - S. Gessner

Water Surface Elevation
61.7 ft. - 20,000 cfs
58.9 ft. - 15,000 cfs
56.0 ft. - 10,000 cfs
52.8 ft. - 6,000 cfs
47.1 ft. - 3,000 cfs

Bridge Deck Elevation
64.8 ft. - Piney Point Rd.

Water Surface Elevation
53.3 ft. - 20,000 cfs
50.7 ft. - 15,000 cfs
47.8 ft. - 10,000 cfs
45.4 ft. - 6,000 cfs
41.6 ft. - 3,000 cfs

Bridge Deck Elevation
58.0 ft. - Voss Rd.

Water Surface Elevation
47.8 ft. - 20,000 cfs
45.1 ft. - 15,000 cfs
42.0 ft. - 10,000 cfs
39.0 ft. - 6,000 cfs
35.4 ft. - 3,000 cfs

Bridge Deck Elevation
57.2 ft. - San Felipe Dr.

Water Surface Elevation
50.0 ft. - 20,000 cfs
47.3 ft. - 15,000 cfs
44.1 ft. - 10,000 cfs
40.8 ft. - 6,000 cfs
37.3 ft. - 3,000 cfs

- Legend**
- Constant_Flow**
- 3,000 cfs
 - 6,000 cfs
 - 10,000 cfs
 - 15,000 cfs
 - 20,000 cfs

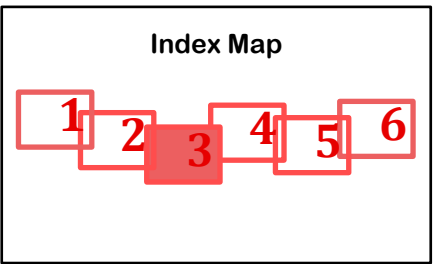

Constant Flow Inundation Map Section 3
Addicks and Barker Reservoirs
Harris County, Texas
Plate 5-05

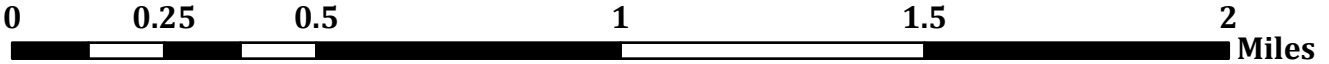

The data is only a representation of features on the earth completed by a computer program from raw data obtained from different sources and is not necessarily, in whole or in part, based upon any physical recording, study or survey, professional or otherwise, of the covered property. This information is not intended as a substitute for a field survey by a professional or any other use or application that requires legal or engineering accuracy.





- Legend**
- Constant_Flow**
- 3,000 cfs
 - 6,000 cfs
 - 10,000 cfs
 - 15,000 cfs
 - 20,000 cfs

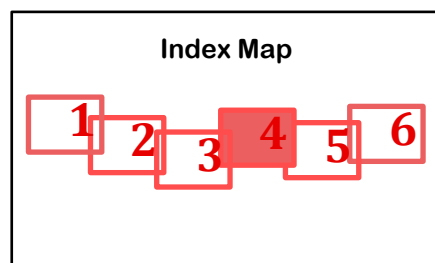

Constant Flow Inundation Map Section 4
Addicks and Barker Reservoirs
Harris County, Texas
Plate 5-06

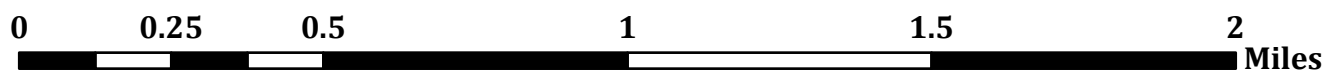

The data is only a representation of features on the earth completed by a computer program from raw data obtained from different sources and is not necessarily, in whole or in part, based upon any physical recording, study or survey, professional or otherwise, of the covered property. This information is not intended as a substitute for a field survey by a professional or any other use or application that requires legal or engineering accuracy.



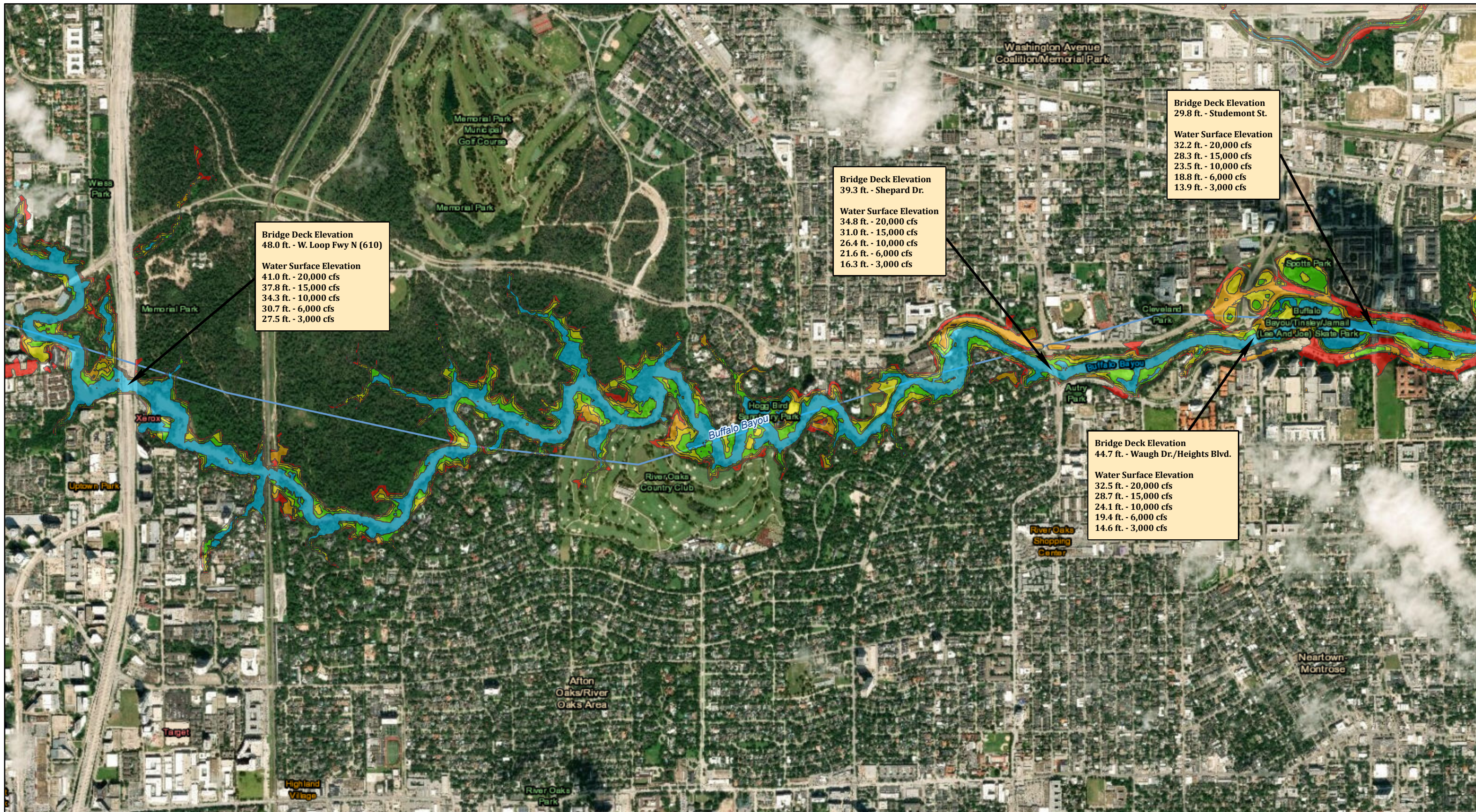

- Legend**
- Constant_Flow**
- 3,000 cfs
 - 6,000 cfs
 - 10,000 cfs
 - 15,000 cfs
 - 20,000 cfs

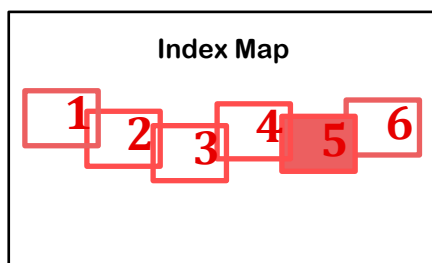

Constant Flow Inundation Map Section 5
Addicks and Barker Reservoirs
Harris County, Texas
Plate 5-07

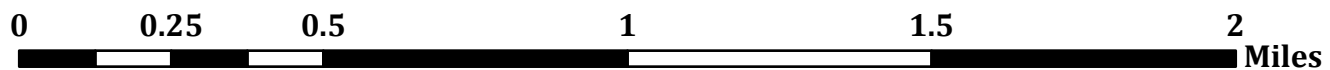

The data is only a representation of features on the earth completed by a computer program from raw data obtained from different sources and is not necessarily, in whole or in part, based upon any physical recording, study or survey, professional or otherwise, of the covered property. This information is not intended as a substitute for a field survey by a professional or any other use or application that requires legal or engineering accuracy.



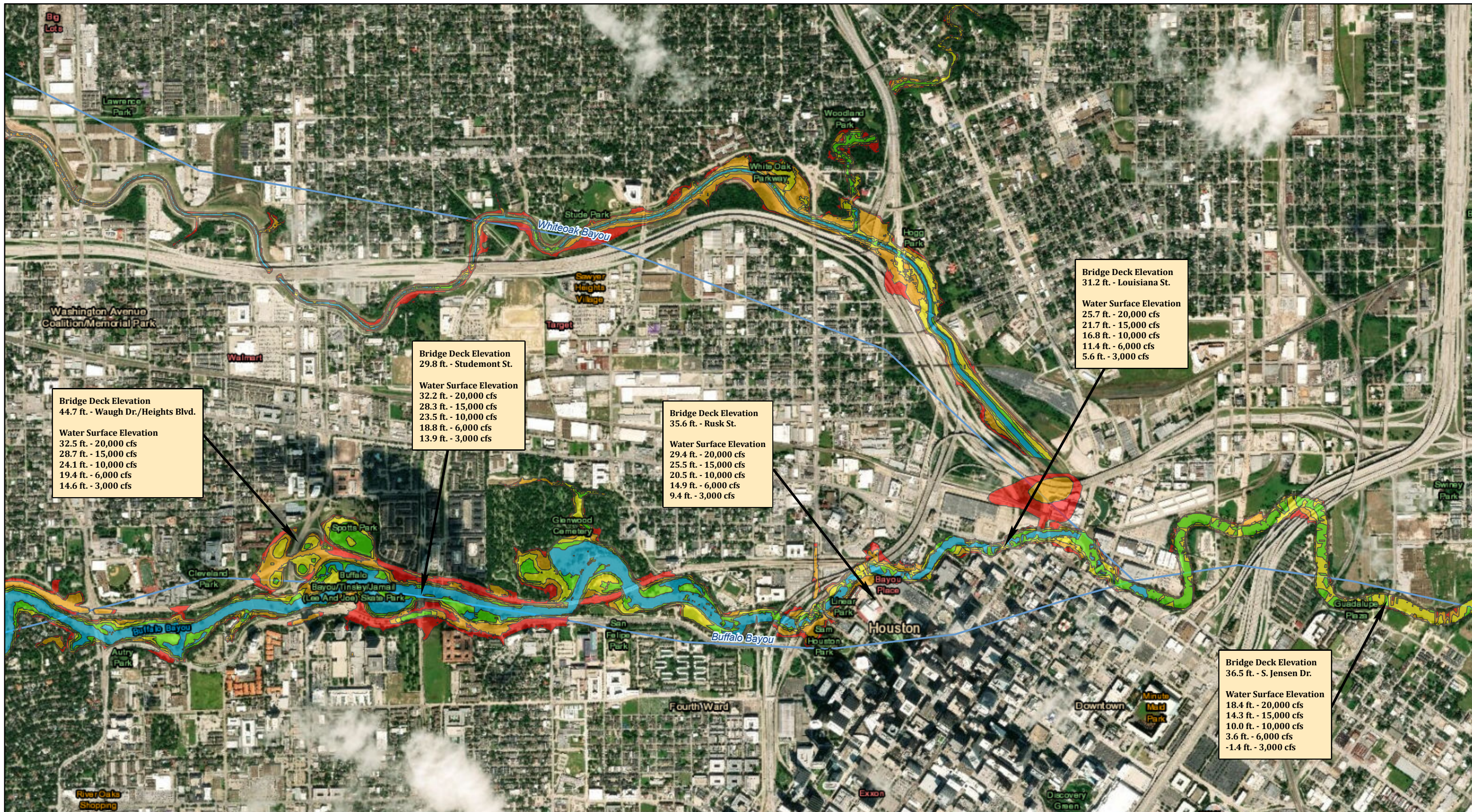

Bridge Deck Elevation
44.7 ft. - Waugh Dr./Heights Blvd.

Water Surface Elevation
32.5 ft. - 20,000 cfs
28.7 ft. - 15,000 cfs
24.1 ft. - 10,000 cfs
19.4 ft. - 6,000 cfs
14.6 ft. - 3,000 cfs

Bridge Deck Elevation
29.8 ft. - Studemont St.

Water Surface Elevation
32.2 ft. - 20,000 cfs
28.3 ft. - 15,000 cfs
23.5 ft. - 10,000 cfs
18.8 ft. - 6,000 cfs
13.9 ft. - 3,000 cfs

Bridge Deck Elevation
35.6 ft. - Rusk St.

Water Surface Elevation
29.4 ft. - 20,000 cfs
25.5 ft. - 15,000 cfs
20.5 ft. - 10,000 cfs
14.9 ft. - 6,000 cfs
9.4 ft. - 3,000 cfs

Bridge Deck Elevation
31.2 ft. - Louisiana St.

Water Surface Elevation
25.7 ft. - 20,000 cfs
21.7 ft. - 15,000 cfs
16.8 ft. - 10,000 cfs
11.4 ft. - 6,000 cfs
5.6 ft. - 3,000 cfs

Bridge Deck Elevation
36.5 ft. - S. Jensen Dr.

Water Surface Elevation
18.4 ft. - 20,000 cfs
14.3 ft. - 15,000 cfs
10.0 ft. - 10,000 cfs
3.6 ft. - 6,000 cfs
-1.4 ft. - 3,000 cfs

- Legend**
- Constant_Flow**
- 3,000 cfs
 - 6,000 cfs
 - 10,000 cfs
 - 15,000 cfs
 - 20,000 cfs

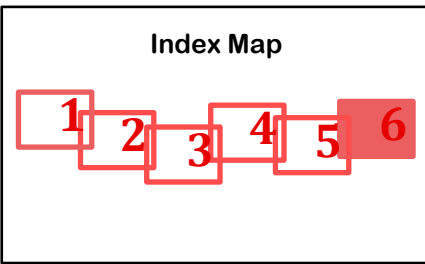

Constant Flow Inundation Map Section 6
Addicks and Barker Reservoirs
Harris County, Texas
Plate 5-08

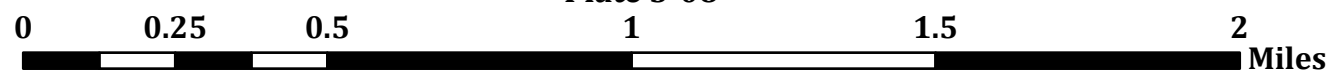

The data is only a representation of features on the earth completed by a computer program from raw data obtained from different sources and is not necessarily, in whole or in part, based upon any physical recording, study or survey, professional or otherwise, of the covered property. This information is not intended as a substitute for a field survey by a professional or any other use or application that requires legal or engineering accuracy.



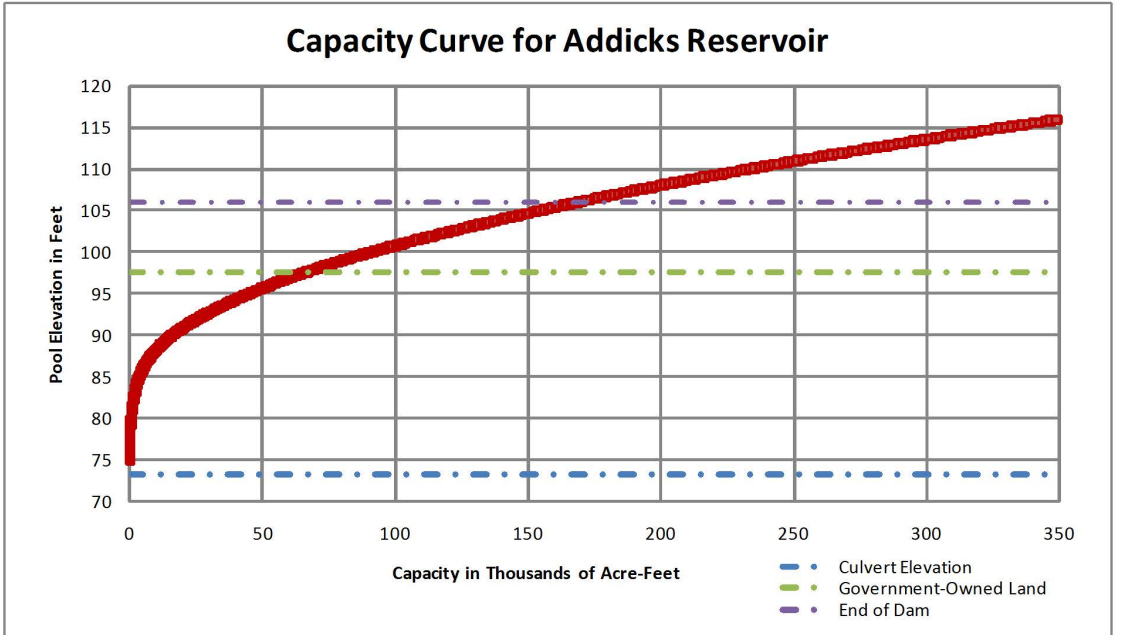
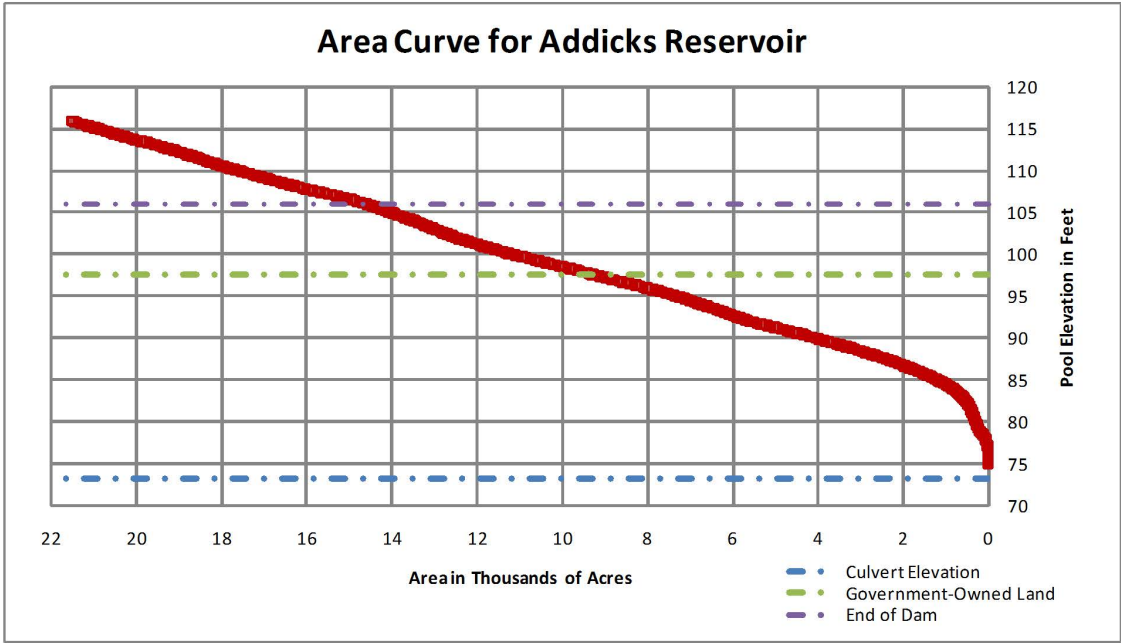

Area-Capacity Curves - Addicks Reservoir

Note: Elevations are NAVD88



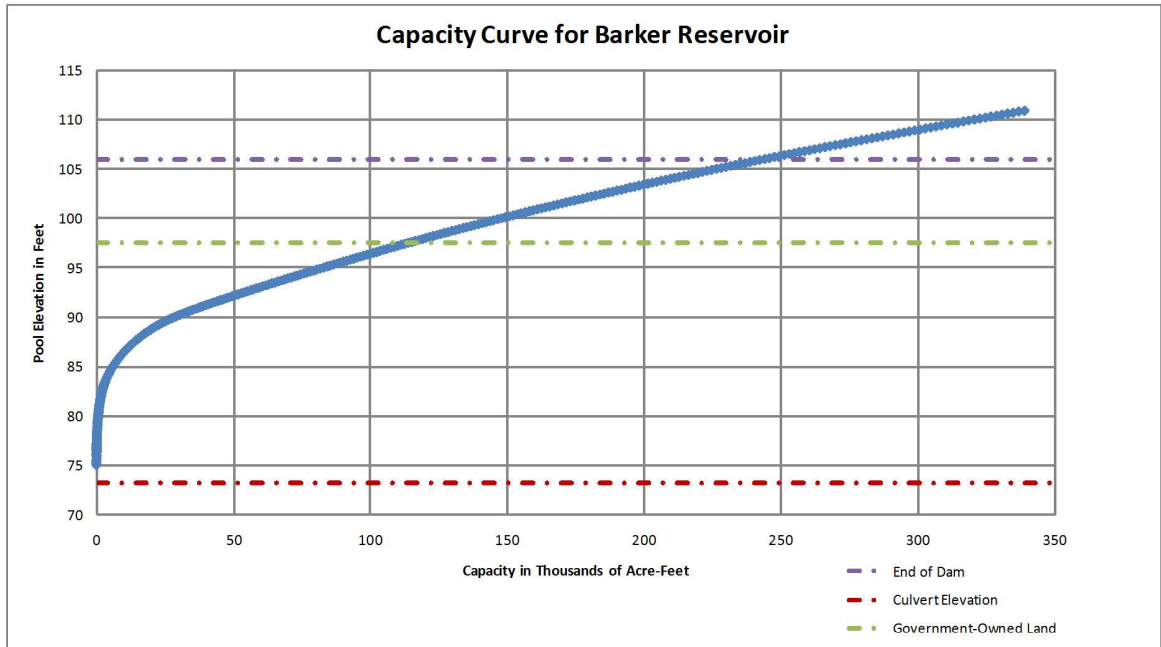
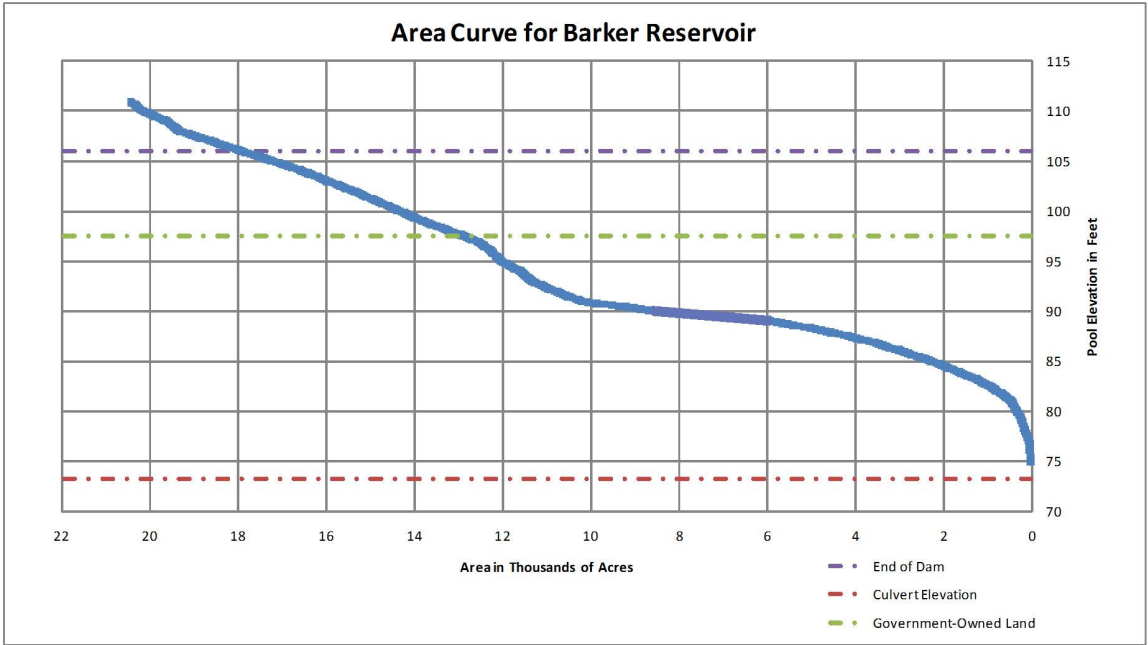

Area-Capacity Curves -Barker Reservoir

Note: Elevations are NAVD88



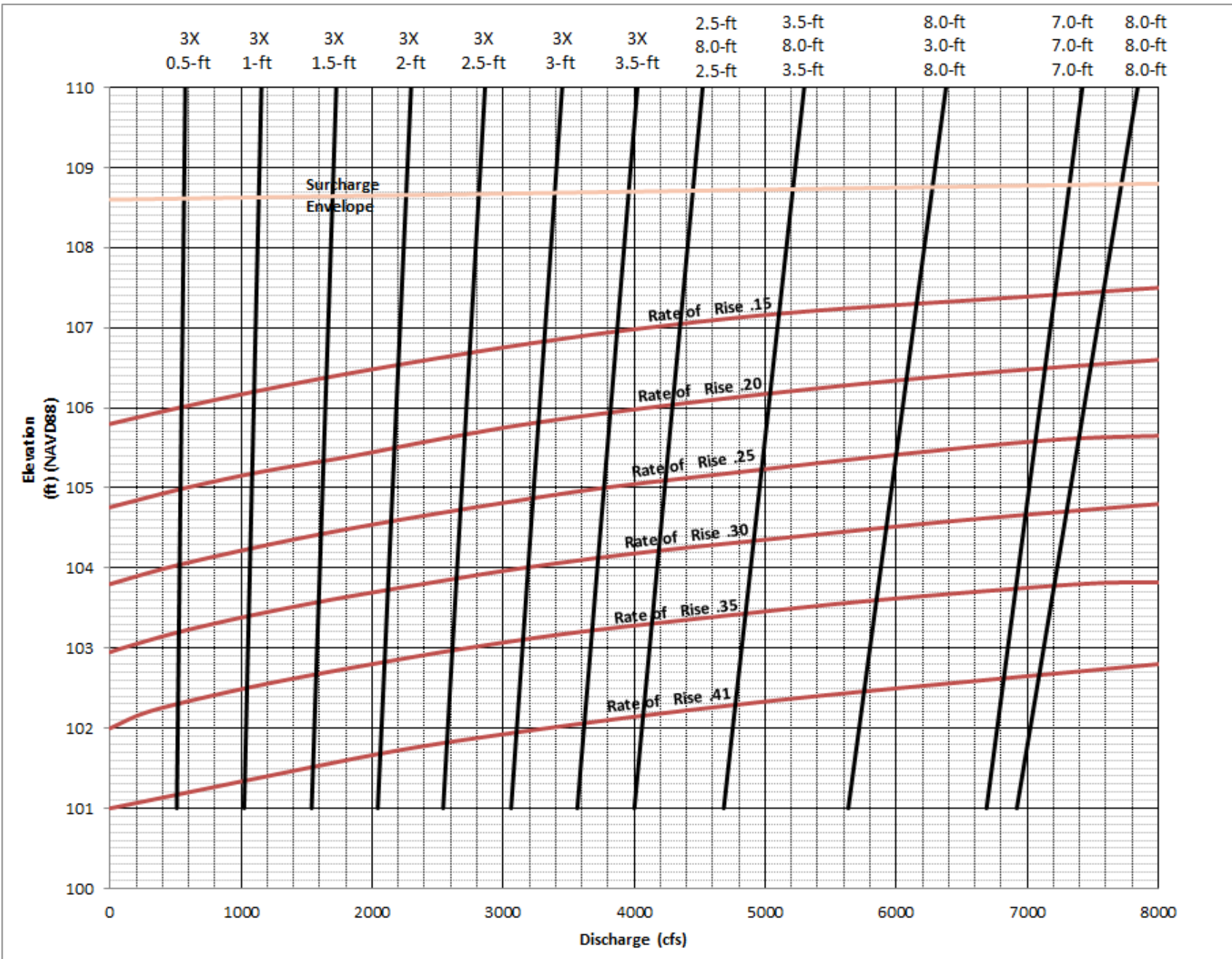

Induced Surcharge Operation Schedule Addicks Reservoir

Source: Derived from the Addicks and Barker Dam Safety Modification Report, July 2015

Note: Provisional until compliant with the USACE Civil Works Review Policy.

Plate 7-03



**US Army Corps
of Engineers**
Galveston District

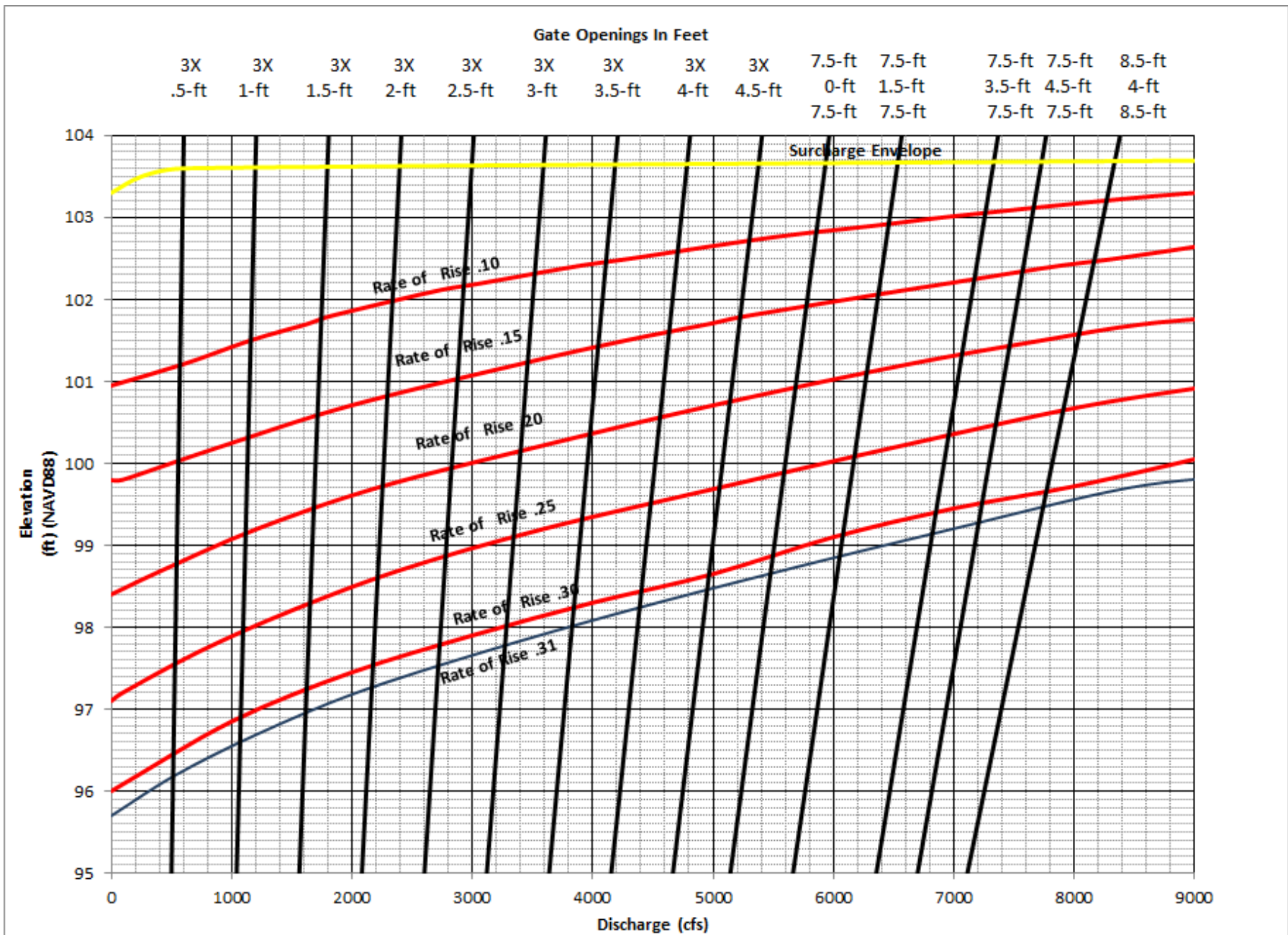

Induced Surcharge Operation Schedule Barker Reservoir

Source: Derived from the Addicks and Barker Dam Safety Modification Report, July 2015

Note: Provisional until compliant with the USACE Civil Works Review Policy.

Plate 7-04



**US Army Corps
of Engineers**
Galveston District

Addicks Reservoir 1-Gate Elevation vs Discharge

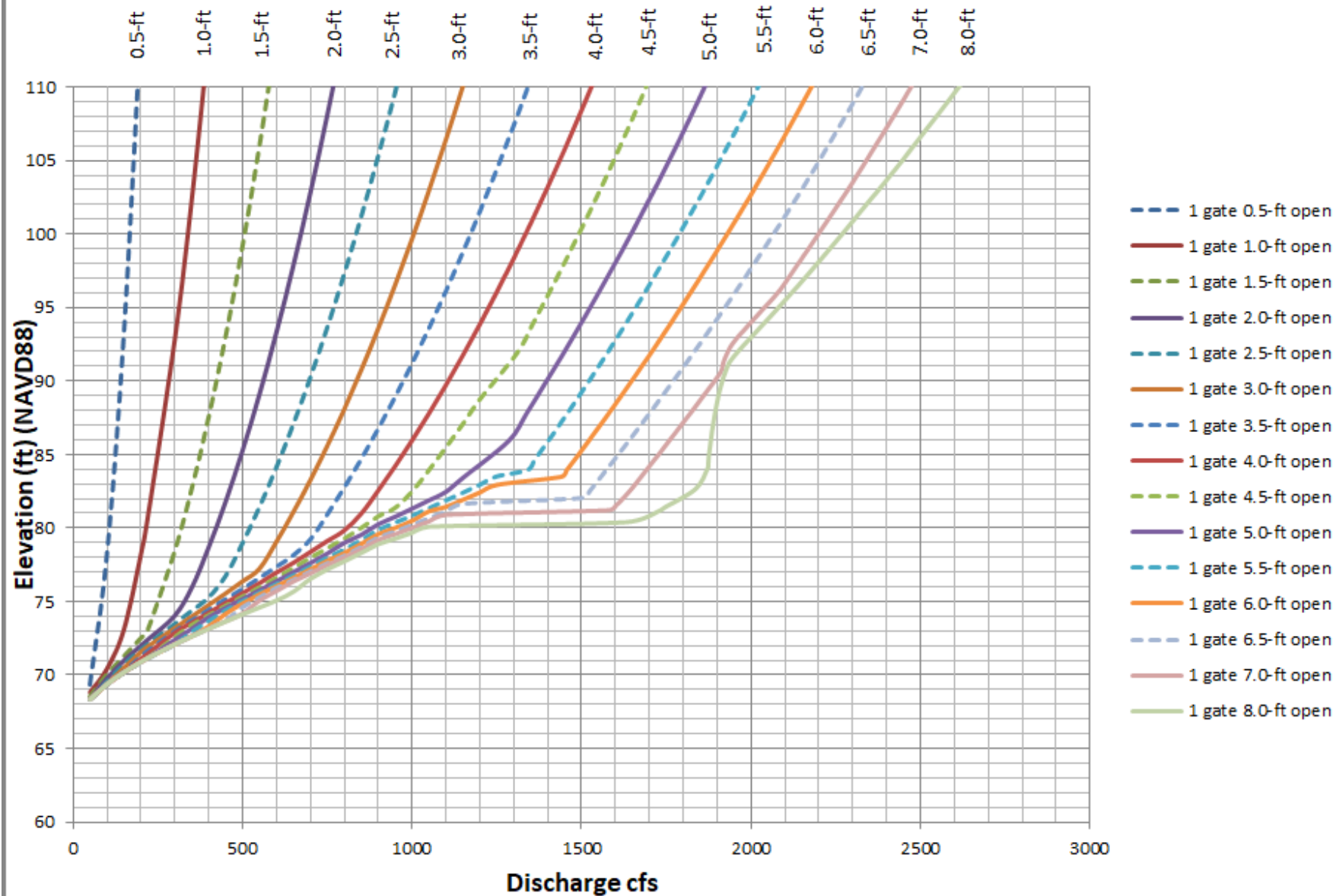

Outlet Works Rating Curves Addicks Reservoir

Source: Derived from the Addicks and Barker Dam Safety Modification Report, July 2015

Note: Provisional until compliant with the USACE Civil Works Review Policy.

Plate 7-05



**US Army Corps
of Engineers**
Galveston District

Barker Reservoir 1-Gate Elevation vs Discharge

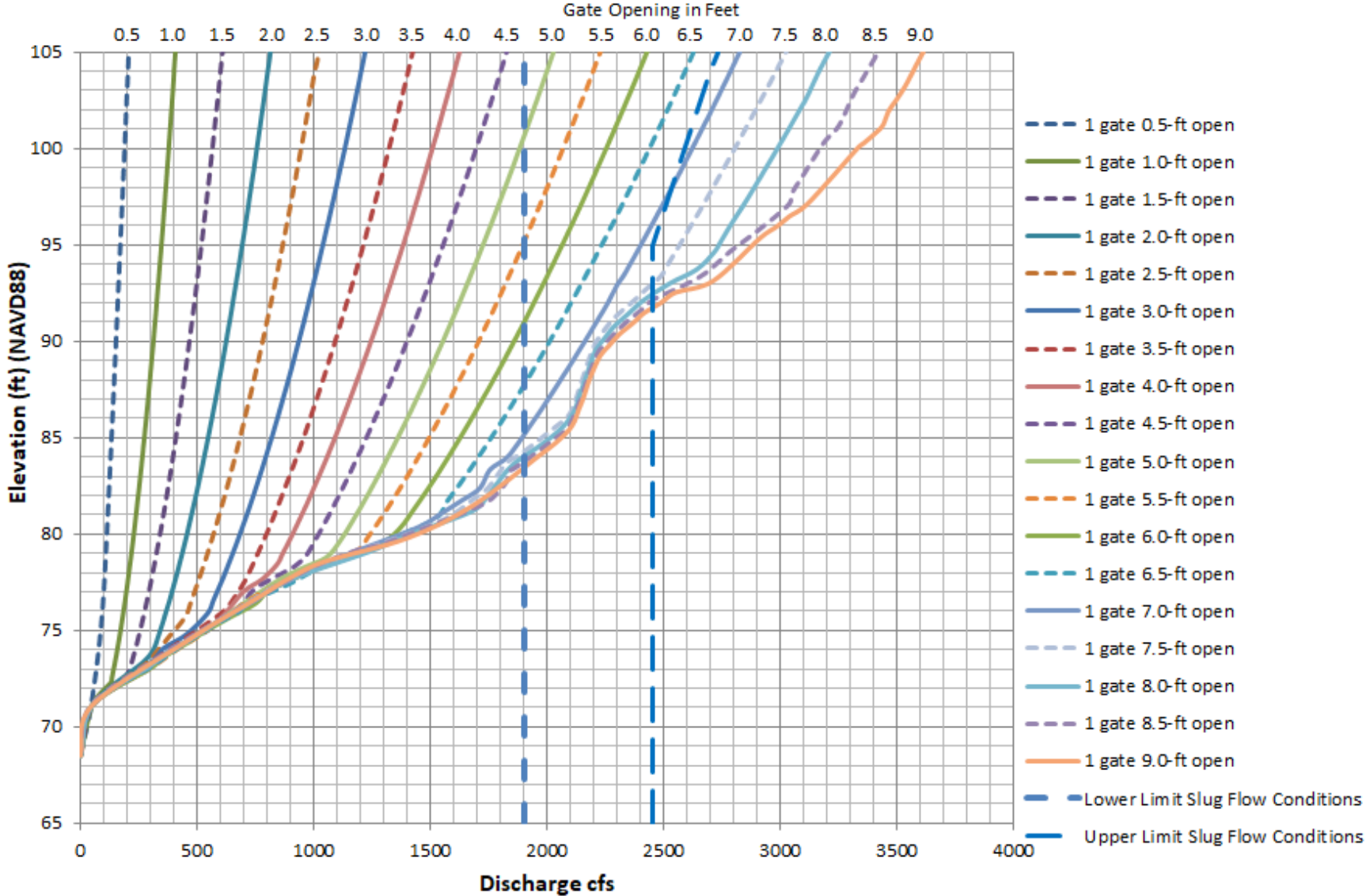

Outlet Works Rating Curves Barker Reservoir

Source: Derived from the Addicks and Barker Dam Safety Modification Report, July 2015

Note: Provisional until compliant with the USACE Civil Works Review Policy.

Plate 7-06



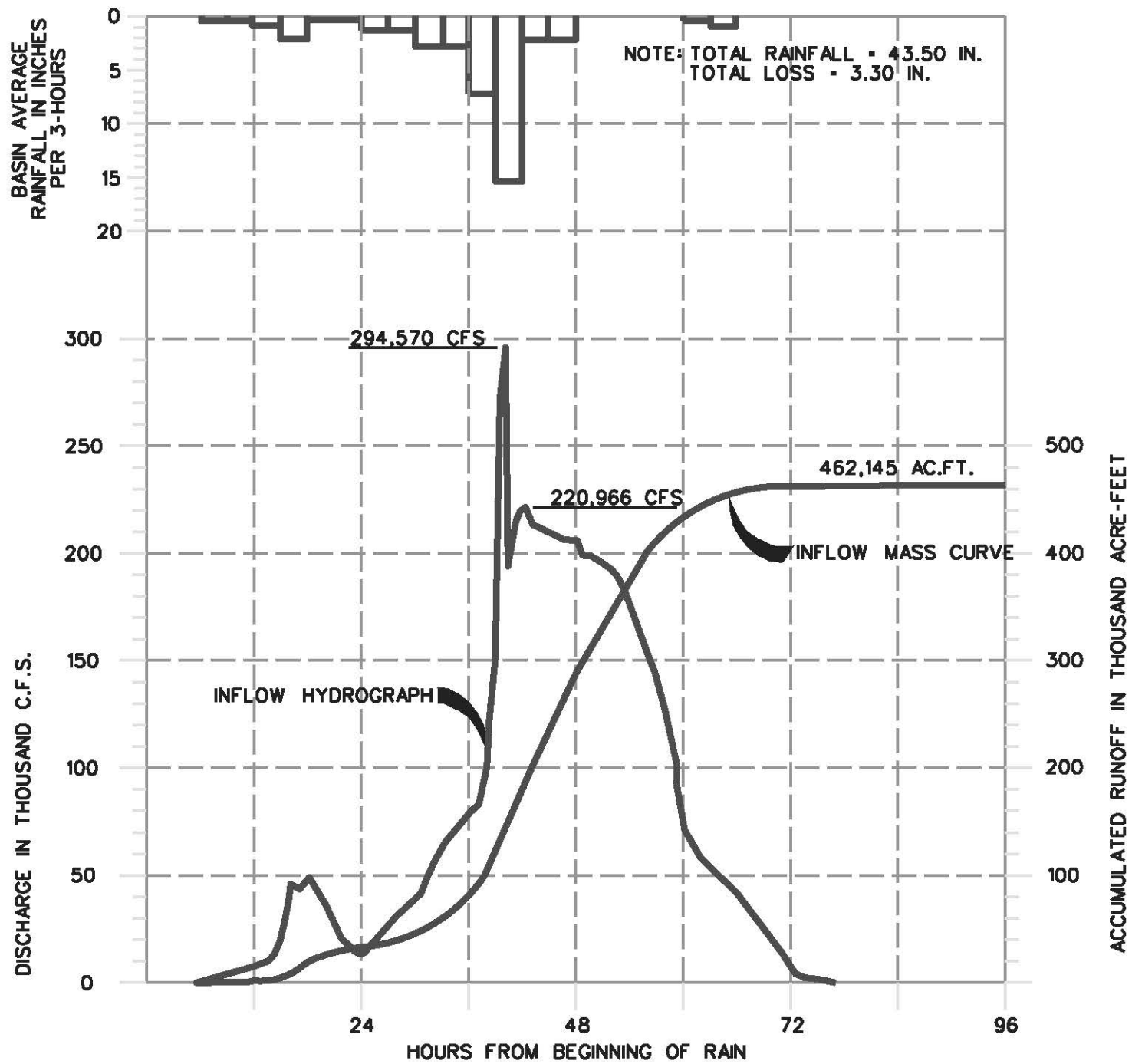

1977 Spillway Design Flood - Addicks Reservoir

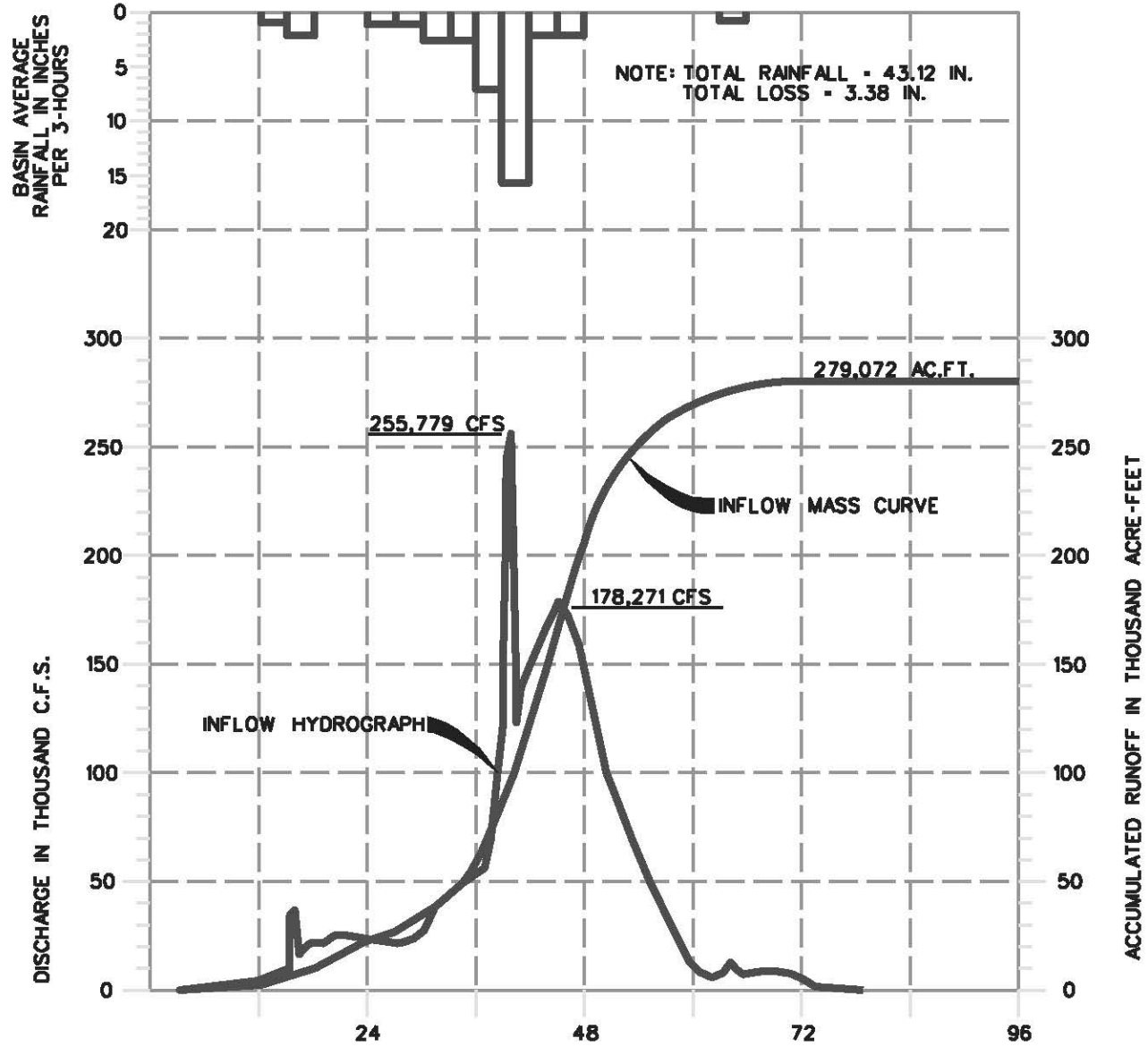

1977 Spillway Design Flood - Barker Reservoir

Plate 8-02

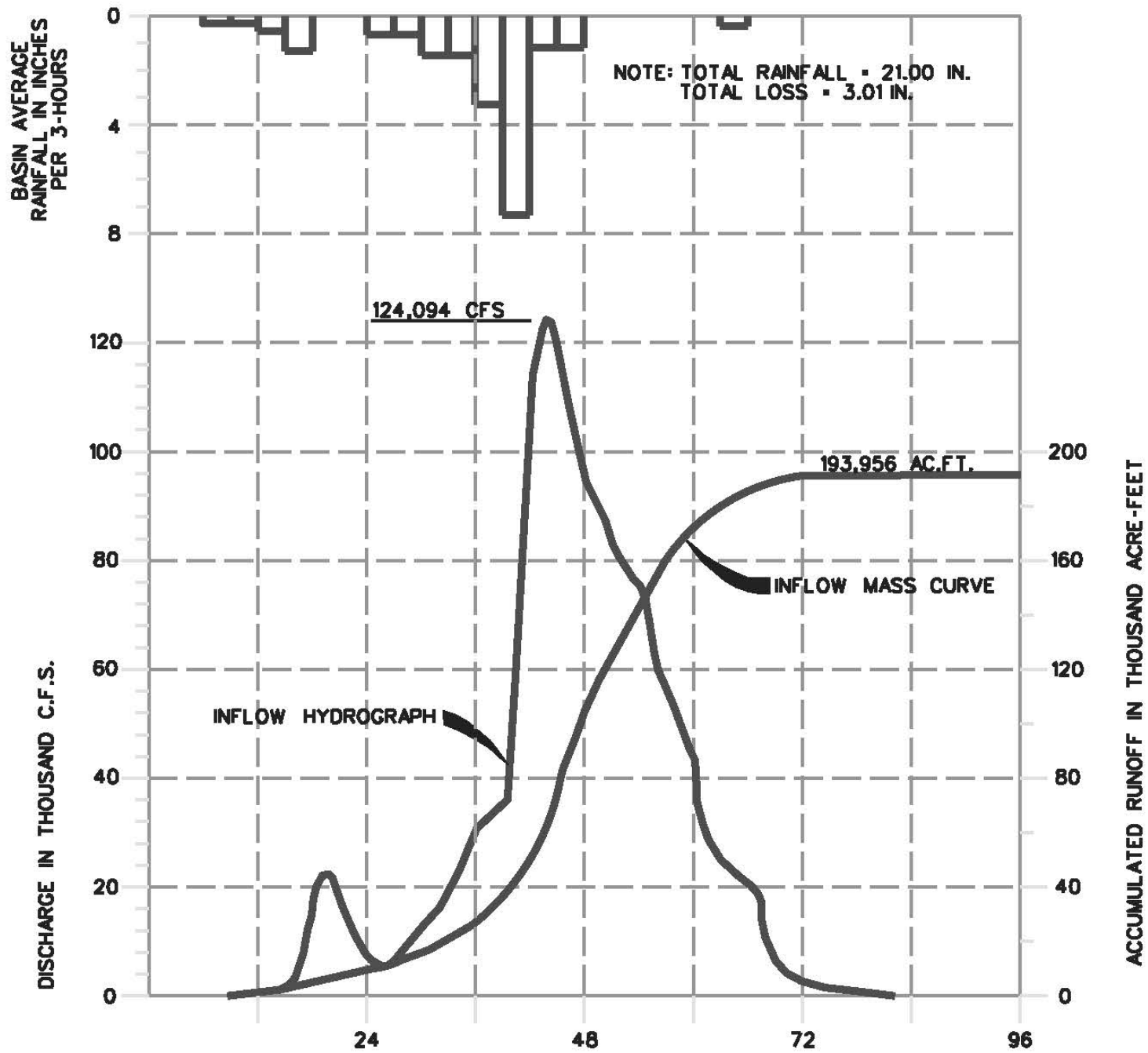

1977 Standard Flood - Addicks Reservoir

Plate 8-03



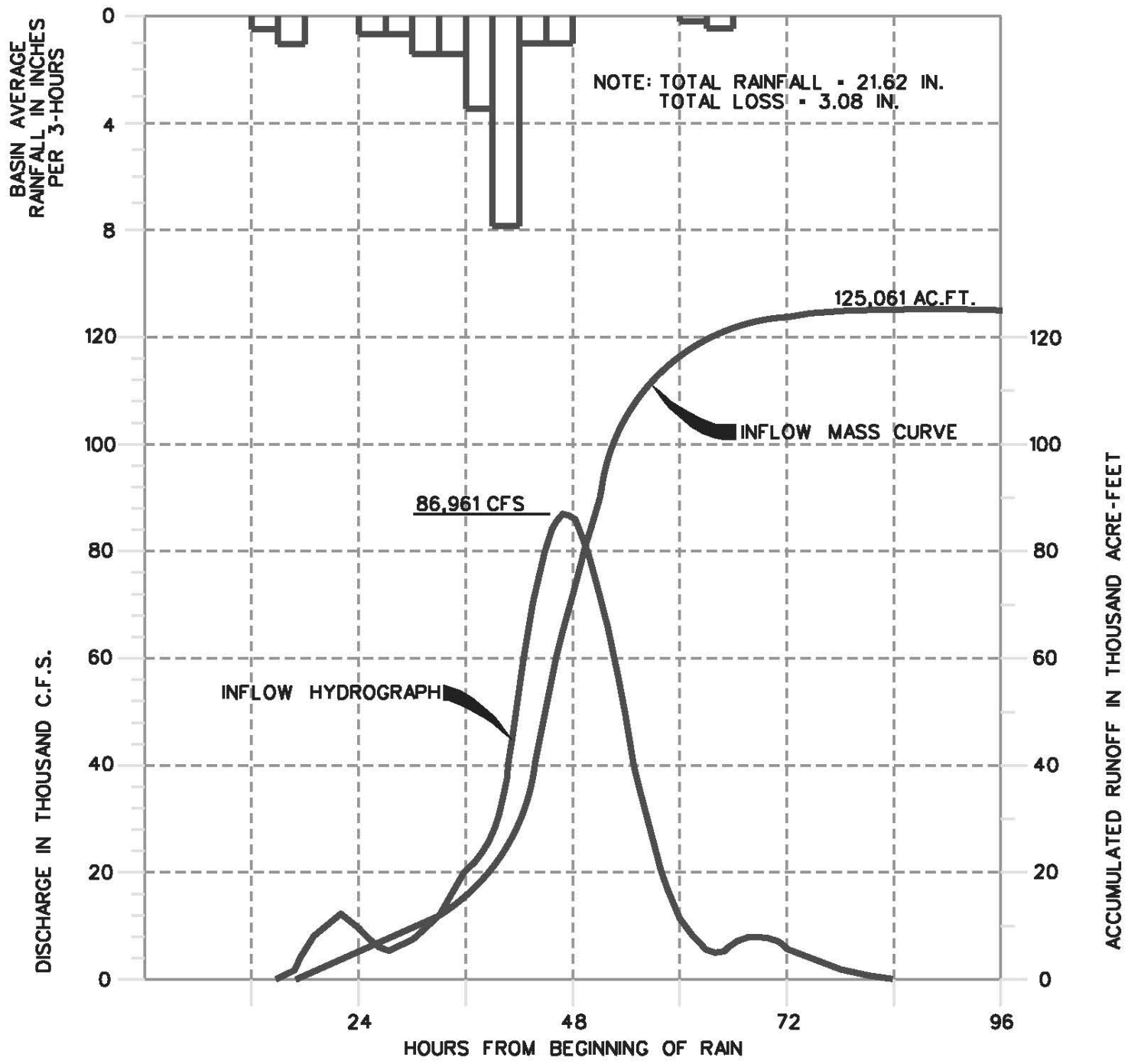

1977 Standard Flood - Barker Reservoir

Plate 8-04



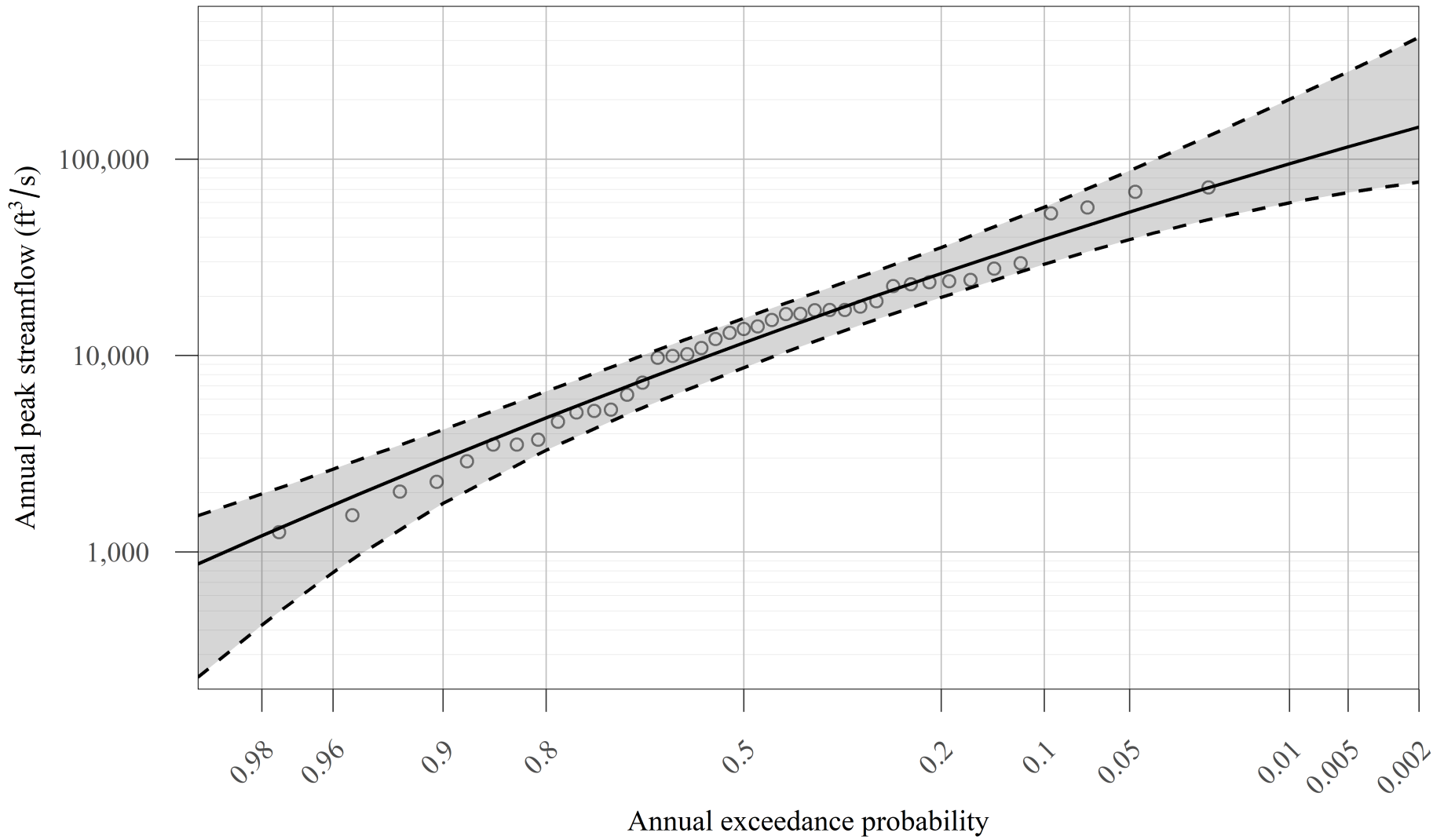

Note: Provisional until compliant with the USACE Civil Works Review Policy.

Pool Inflow-Frequency Curve Addicks Reservoir

Plate 8-05



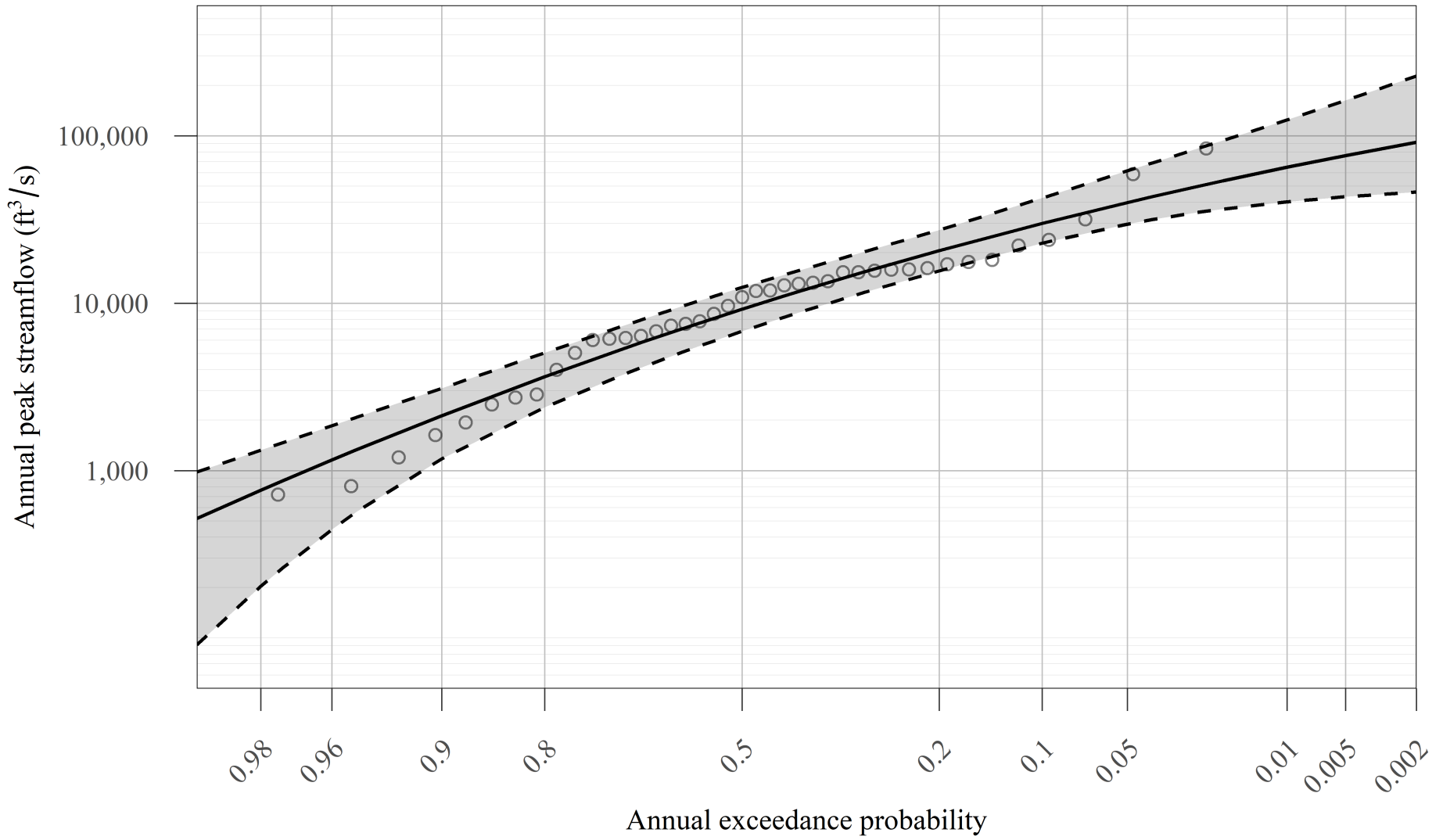

**Pool Inflow-Frequency Curve
Barker Reservoir**

Note: Provisional until compliant with the USACE Civil Works Review Policy.

Plate 8-06



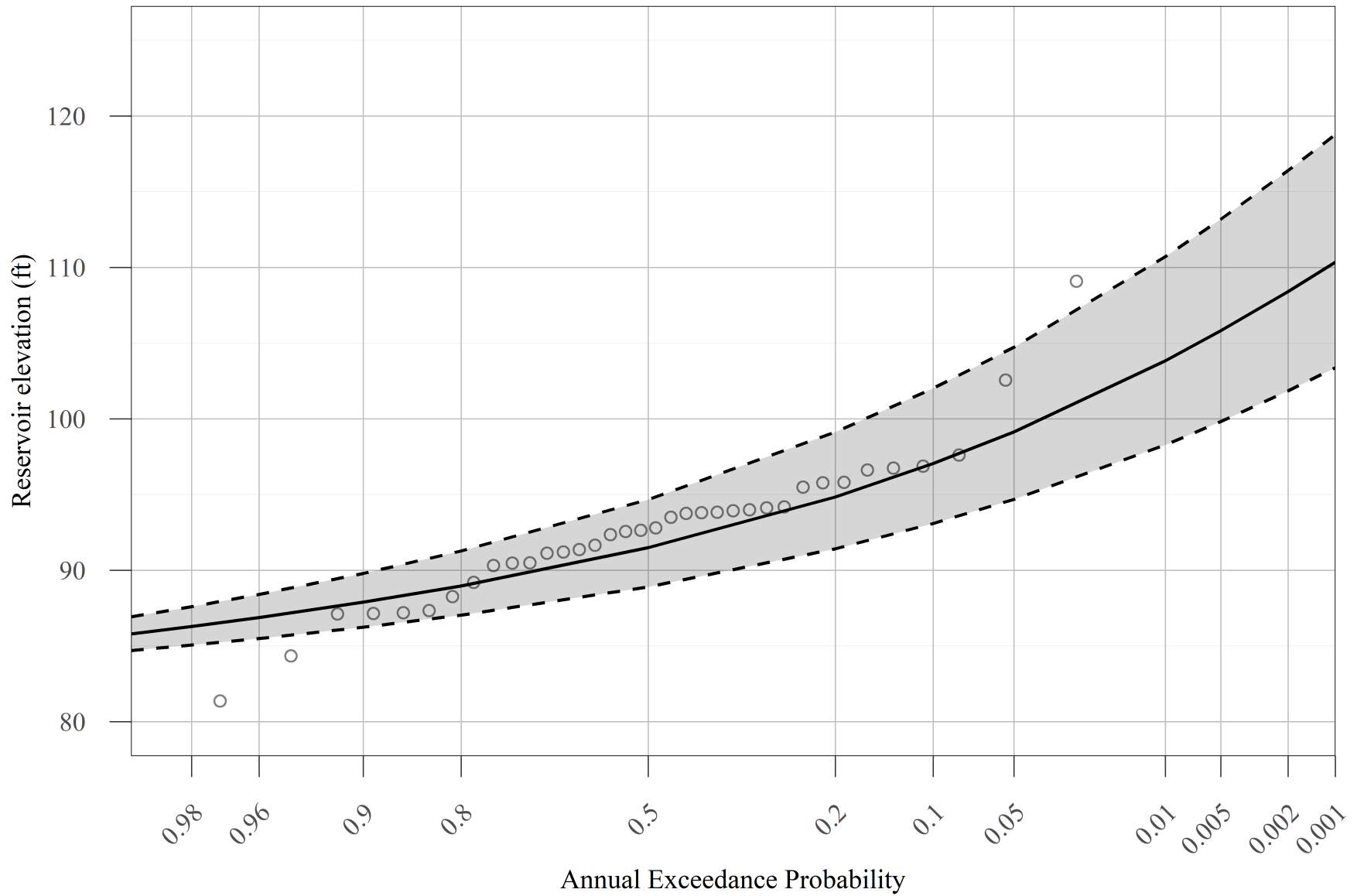

**Pool Elevation-Frequency Curve
Addicks Reservoir**

Note: Provisional until compliant with the USACE Civil Works Review Policy.

Plate 8-07



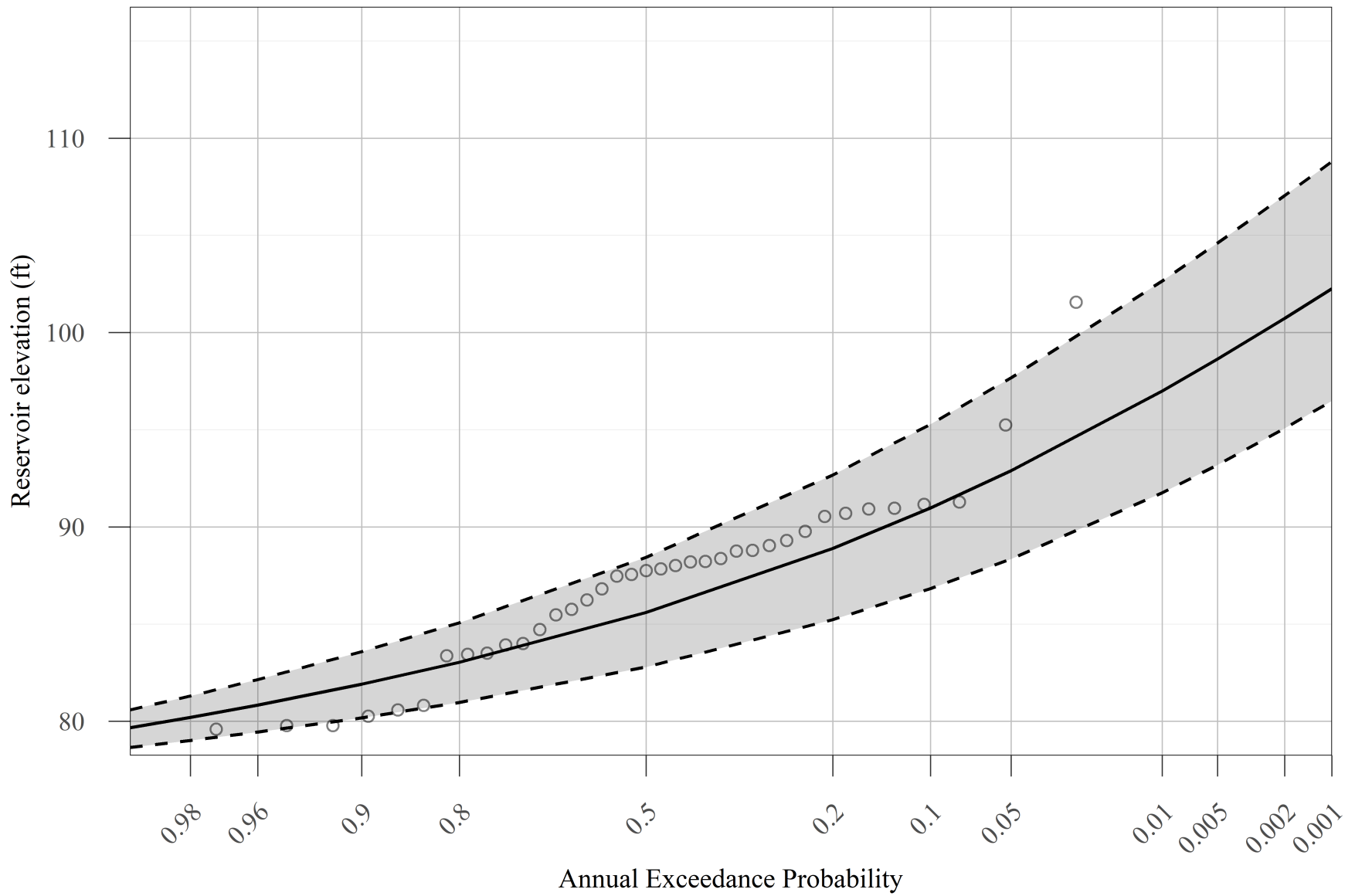

**Pool Elevation-Frequency Curve
Barker Reservoir**

Note: Provisional until compliant with the USACE Civil Works Review Policy.

Plate 8-08



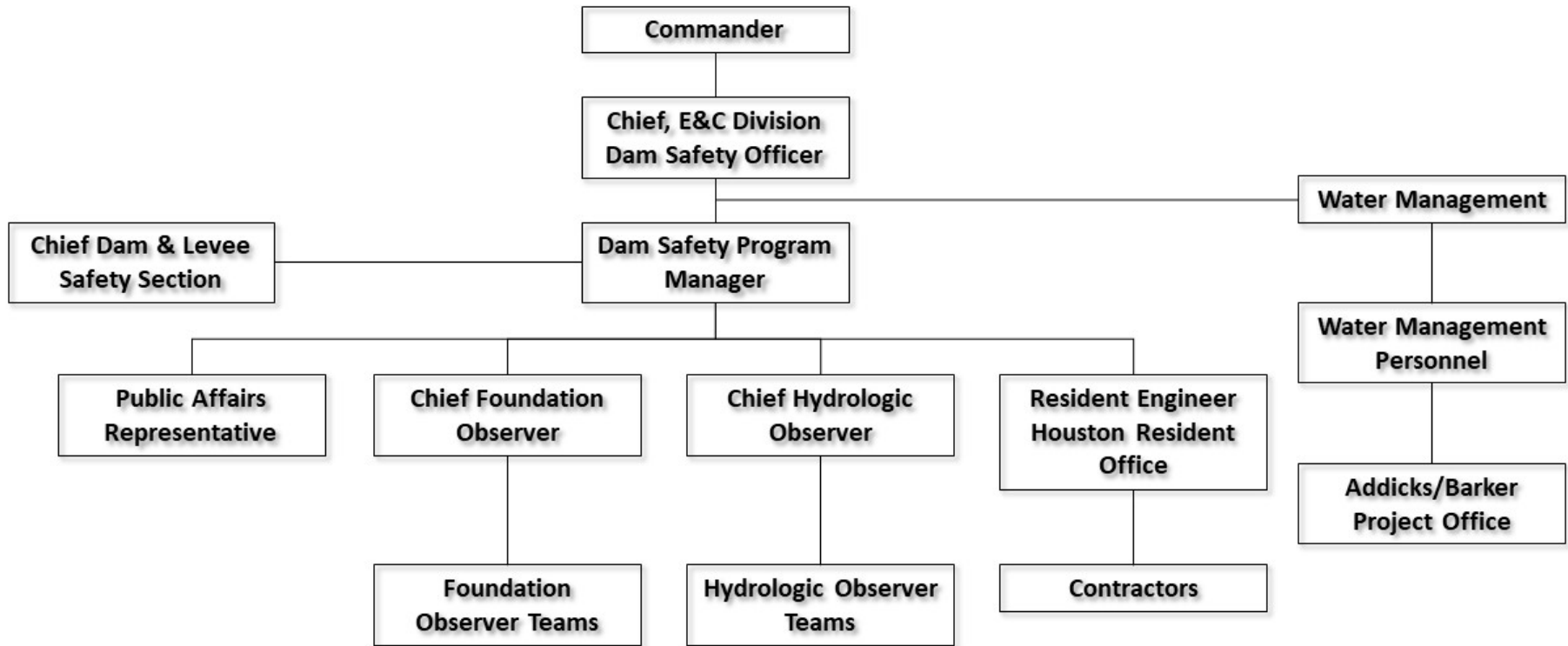

Organization and Communication Chart for Water Management